

**BE AN  
ELECTRICIAN**

# 20 Lessons in Electricity FREE

**LEARN  
AT  
HOME**

Here's the chance you've been waiting for! Here's your opportunity to get out of the small pay class. Here's your opportunity to earn the money and do the kind of work your ambition calls for! Write me at once—TODAY! Just send the coupon or a postal. I will give you 20 complete lessons in practical electricity FREE! Think of it! My personal and individual instruction for 20 lessons without a cent of cost to you if you act quick. No charge to you for these 20 lessons, now or later. I make this sensational offer to secure a few more live students—to show, too, how quickly I can make you a Master Electrician, no matter where you live, or what you do. But you must act at once! This offer is for a limited time only. Remember, these free lessons are not merely sample lessons, but are a regular part of my full and complete course in electricity. Send the coupon without delay—TODAY!



**A. W. WICKS, E. E.**

*Formerly with the General Electric Co.; former General Manager of company manufacturing Jenney Electric Motors; also formerly with Fairbanks, Morse & Co.; now Consulting Engineer and Director of the Wicks Electrical Institute.*

**EARN \$2,500 TO  
\$4,000 A YEAR**

Others are doing it. Don't let false fear or doubt say you can't! Give the better man within you a chance on this great opportunity. You can now qualify at home during your spare time, and without giving up your present position or occupation, for the most wonderful of all fields open to the ambitious man—the great and growing field of Electricity! Yes, no matter if you don't know a thing about electricity or never had a bit of electrical experience, I will take you in hand and make you an Expert Electrician, so that you should easily earn \$2,500 to \$4,000 a year and more. And I'll do it so quickly and with so little effort on your part, that you'll wonder how it was possible. No books or tools to buy.

## I TRAIN YOU BY MAIL

I will instruct you personally—make the whole matter so simple for you that you can't help but learn. When you have finished my instructions you are an Expert Electrician—ready to take a big paying job or start in for yourself. I show you not only how to do practical electrical work, but how to estimate on jobs so that you can take contracts at big profits. That's what it means to be trained by a man of my practical experience. Don't let anyone tell you that you can't learn electricity through home study. You positively can, NOW, since I have perfected my wonderful method of instruction. Remember, too, that my instruction is practical, as I am a practical Electrician. See what my students have to say!



**ACT QUICK**

## Mail Coupon Today

**A. W. Wicks, E. E., Director, Wicks Electrical Institute  
81 West Randolph Street, Dept. 250 Chicago, Ill.**

Without obligation to me whatever, please send me full description of your personal instructions in Electricity and particulars of your special offer of 20 lessons free.

Name .....

Address .....

City ..... State .....

## Act Quick!

Electricians are needed now more than ever! Our marvelous industrial activity is opening up new jobs every day. Electricity is the life spark of modern industrial activity. The man who knows electricity has the big chance today. I want to hear from you immediately. Don't miss my offer of 20 personal lessons free. Remember, this offer is strictly limited. Write for all particulars at once. Here's your chance. No obligation to you. Send coupon or postal.

**A. W. Wicks, E. E., Director  
WICKS ELECTRICAL INSTITUTE  
81 West Randolph St. Dept. 250 Chicago, Ill.**



# DUCK'S NEW BIG No. 11 300-PAGE ELECTRICAL and WIRELESS CATALOG

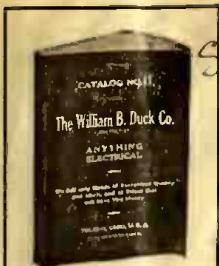

Only 8c in stamps will bring this unrivalled catalog to your home. The great cost of catalog and the exceptionally low prices (often times fully 25% below usual retail price) prohibits its distribution otherwise. You may deduct the 8c on first \$1.00 purchase.

MORE THAN EVER JUSTIFIES YOUR VERDICT THAT IT IS THE ONE CATALOG WORTH WHILE

150 pp. wireless instruments

150 pp. electrical supplies

## ANNOUNCEMENT WIRELESS AMATEURS

We announce effective at once these exceedingly attractive reductions on the following wireless instruments:

Type	Description	Price	Price	No.	Description	Price	Price
Type T-0	Thordarson Flexible Step-Up Transformer	\$15.00	\$12.25	No. 1915	Detector Stand	\$2.00	\$1.50
Type T-1	Thordarson Flexible Step-Up Transformer	20.00	16.25	Model 5AA	Navy Type Receiving Transformer	19.00	17.25
Type T-2	Thordarson Flexible Step-Up Transformer	25.00	19.75	No. 1091	Arlington Receiving Transformer	9.00	7.00
				No. 1092	Arlington Type B Receiving Transformer	7.00	6.50
				No. A7721	Receiving Transformer	6.00	5.75
				No. 44X6	1 inch Spark Coil	4.00	3.75
				No. 39X0	1/4 inch Spark Coil	2.00	1.80
				No. 40X0	1/2 inch Spark Coil	3.00	2.75
				No. A6012	Detector Stand	4.00	3.50
				No. 61X10	Standard Tuning Coil	3.00	2.75
No. A395	Commercial Type Oscillation Transformer	15.00	13.50	No. A560	Pancake Helix	1.00	1.30
No. A7628	Oscillation Transformer	6.75	5.75	No. 71X0	Electrode Insulator	1.00	.75
No. R41	Receiving Set with Condensers	32.00	29.50	No. 73X0	Electrode Insulator	1.00	.75
No. R41	Receiving Set less Condensers	24.00	22.00	No. 17X0	Electrode Insulator	1.00	.75

### WHAT OUR BIG CATALOG CONTAINS

150 pages wireless instruments, 10 pages raw material; storage batteries; electrolytic rectifiers; high frequency coils; instruments; commercial and battery motors and dynamos; rotary converters; alternators; sewing machine motors; medical batteries; auto accessories; flashlights; electric lighting plants; Victrolas; books and general electric supplies.

Send 8c for this Catalog today. You need it

**The William B. Duck Co., 230-232 SUPERIOR ST. TOLEDO, OHIO**

**NEW YORK ELECTRICAL SCHOOL**

Wireless Men  
Lighting Engineer  
Telephone Engineer  
Power Engineer  
Meter Engineer  
Armature Winding  
Electrical Engineer  
Switch Operator

**"Learn by Doing"**

WRITE FOR OUR FREE BOOK ON ELECTRICITY

—a profession that is constantly calling for steady hands and a good head. The rewards are big for those with a knowledge—not just book knowledge, or a smattering of practise. The New York Electrical School has started over 3,000 men to successful electrical careers. "LEARN BY DOING" is our principle. We have our own building, equipped with the latest electrical apparatus, where you carry out in actual practise every problem of the electrical industry. This free book will show you how thoroughly we teach. Write for a copy. Address: The New York Electrical School, 29 West 17th Street, New York.

Don't forget to mention "The Electrical Experimenter" when writing to advertisers.





# LENZITE CRYSTAL DETECTOR

Patented May 2nd, 1916

A first class Wireless Detector is half the battle in the wireless game. Have you tried the best and most effective, The "Lenzite" Crystal Detector?

## Why Is Our Detector Near Perfection?

If you want to have a perfect receiving detector, try ours. If not satisfactory, return same within thirty days and we shall be pleased to refund you the price.

Being a user of an Audion Bulb and having firmly, after due test and consideration of "mineral detectors," discarded them as unstable and unreliable and very inconvenient, being hard to keep in adjustment, I was very skeptical as to Lenzite, but glad to make the test and more than pleased that I did so.

I found that the reception of signals with Lenzite as a detector quite beyond any hopes that I may have had.

Inasmuch as the mineral in question (Lenzite) seems to be "sensitive" nearly all over its surface on all sides, which is a very great advantage as it makes it almost as easy to keep in adjustment as an audion, and brings in the signal, when proper attunement is accomplished, in a very loud and positive manner, and I must add I was greatly surprised as it, without any question, has given me far greater results than any other sort of mineral detector I have tried, and I have tried to get all that I have been able to hear of.

Its clear, loud, readable demonstrations should make it very desirable to operators whether or not they use audions, which consume power which Lenzite does not, and it is quite as good for long distance work as well. I shall be glad to tell others of it.

Very truly,

HERBERT W. TRISCOE  
(6 IH U.S. License.)

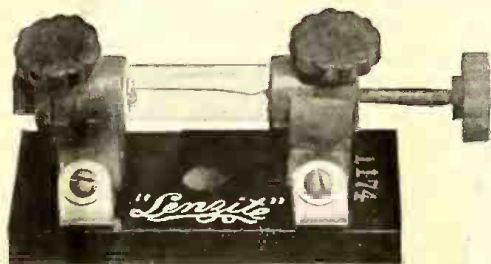

Send money order, express order or check for \$5.00 and we will send you, postage prepaid, one of our Lenzite wireless detectors.

**LENZITE CRYSTAL CORPORATION**  
537 Chamber of Commerce Building Pasadena, California

# VACUUM TUBE DETECTORS

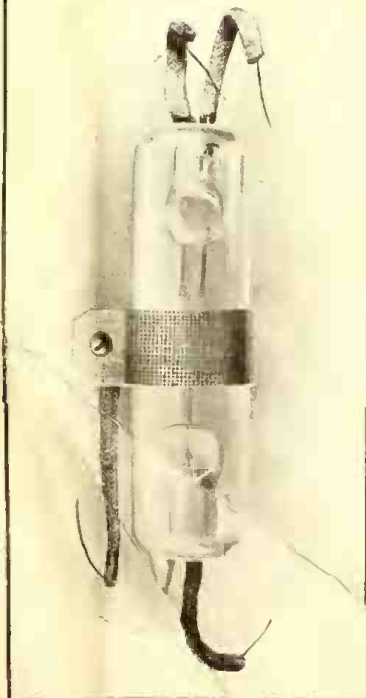

## Notice to Our Customers

Have you received our new circulars containing our guarantees?

Is the tube you purchased from us giving you absolute satisfaction?

Remember we live up to our guarantees.

This detector does not employ or incorporate an evacuated vessel containing three electrodes, namely, a filament, a plate, and a grid disposed between the filament and plate.

**DEALERS:--WE ARE STILL ON THE JOB**

*Write for Circulars*

**PACIFIC LABORATORIES SALES DEPT.**  
534 Pacific Building San Francisco, California

# The Electrical Experimenter

233 Fulton Street, New York.

Published by Experimenter Publishing Company, Inc. (H. Gernsback, President; S. Gernsback, Treasurer; M. Hymes, Secretary), 233 Fulton Street, New York

Vol. IV Whole No. 47

CONTENTS FOR MARCH, 1917

No. 11

FRONT COVER—"ELECTRIC FLYER MAKES 500 MILES AN HOUR".....From a painting by George Wall	
VOLCANO-ELECTRIC PLANT THAT DEVELOPS 15,000 HORSE-POWER.....	789
20,000 LEAGUES UNDER THE SEA.....	791
SHOOTING BIG GAME ON THE ELECTRIC "MOVIE" TARGET TRAVELING AT 500 MILES PER HOUR IN THE FUTURE	792
ELECTRIC RAILWAY.....	794
AN ELECTRIC "MOVIE" MACHINE FOR THE HOME.....	795
HOW ELECTRO-PNEUMATIC TUBES SHOOT MAIL UNDERGROUND.....	797
ELECTRICITY AND LIFE.....By Dr. Frederick Finch Strong	798
ONYBENZYL METHYLENGLYCOLANHYDRIDE.....	801
EXPLOSIONS AND EXPLOSIVES—SECOND PAPER OF A NEW SERIES—"EXPERIMENTAL PHYSICS".....	804
By John J. Furia, A.B., M.A., F.K.S.	
THE WASHINGTON'S BIRTHDAY RADIO RELAY.....	805
By W. H. Kirwan (9xE)	
RADIO DEPARTMENT—RADIO CONTROL SCHEME.....	806
DE FOREST VS. THE ELECTRICAL EXPERIMENTER.....	808
THE CALCULATION AND MEASUREMENT OF INDUCTANCE—PART I.....	812
by H. Winfield Secor and Samuel Cohen	
STAGING A SCIENTIFIC ENTERTAINMENT.....	819
By Raymond Francis Yates	

## Tapping the Earth's Heat



As the world progresses, it becomes more and more apparent to students of economics, as well as to the layman, how utterly inefficient and archaic our present coal-burning practise is. There is certainly no greater anomaly than our present coal age, and we may be quite sure that our great-grandchildren will read with amazement how supposedly intelligent people the world over were using such an expensive make-shift as coal.

There is an excuse for the steel manufacturer using coal when he can mine it at his door. But there is no excuse for a manufacturer or a householder using coal a thousand miles or more distant from the mines. It is simply our present lack of knowledge as well as our gross inefficiency that makes such things possible. First, we mine the coal, compelling men, who could be employed to vastly better purposes, to be imprisoned for life within the bowels of the earth. Then we re-handle the coal a dozen times before we load it on trains. Then we haul it over unbelievable distances, burning more coal in locomotives as we go along. Then, if there is no rail blockade, just at the time when coal is needed most, we dump it into someone's yard a thousand miles away from the mine. Next, we load it once more and then sell it to a jobber and he in turn dumps it into another yard. He too sells it again to a dealer who dumps it into his own yard. The dealer, after he kept it long enough, loads it once more and he also dumps it again, this time into the bins of the ultimate victim. In the meanwhile the coal has been rolling up an avalanche of profits and interest as well as extraordinary expenses in foolish transportation and re-transportation. So at the end of the tortuous road, coal worth \$3.00 a ton at the mine, now sells for \$7.00 and even \$12.00 a ton! It speaks well for us.

But this does not finish the story by any means. After re-handling it a few more times, we now burn the coal and while we do get a little expensive heat, we vitiate the air, poison our lungs, make no end of dust and finally we must dump the burned coal—ashes—once more. And removing ashes costs additional money. Whence we remove ourselves to our library and read the latest magazine which tells us what a wonderfully enlightened race we are. This makes us feel real proud of ourselves.

Of course, happy to relate, the whole world is not peopled by fools. We are slowly beginning to realize that there are other things to give us heat, light and power besides coal. First and foremost we have "white coal"—our waterpower. It costs less to transport horse power by wire than by rail. Thus enlightened Syracuse runs its electric street cars by the power ob-

tained from Niagara Falls, 150 miles distant. And of late the great Chicago, Milwaukee and St. Paul Railroad runs all its electric trains over a distance of 440 miles—not by coal, but by waterpower translated into electricity and led over thin wires along the tracks of the railroad.

But waterpower plants are comparatively scarce. Soon there will not be an untapped waterfall which is not working to full capacity. What then? Our answer comes from Italy. And this time the answer is not visionary, or an editorial pipe dream either. For Prince Ginori-Conti now has a huge power plant located in a volcanic region, which gives him 15,000 horse power every second of the day as well as during the night. He simply taps the heat of our earth by sinking pipes five hundred feet underground and by this natural heat costing nothing, he obtains heat for his boilers which in turn drive the electric turbo-generators.

What he can do anyone can do at any point of the globe. True his conditions are favorable, for he did not need to sink his pipes very deep. But great depths are no obstacles to a good engineer to-day.

Speaking generally if we drill a hole straight down into the earth the heat increases 1° Fahrenheit for every 40-50 feet. This means that under adverse conditions we must sink our pipes from 8,000 to 9,000 feet before we will reach a level where we strike 212° Fahrenheit, at which temperature water changes into steam. Huge as such a depth is, as well as huge the cost to reach it, it is not unpractical. Remember it needs to be done only once; after that we will enjoy free power for centuries to come. Moreover, in many localities 212° will be reached at a depth of less than 2,000 feet. In exceptional localities such as Yellowstone Park, boiling water comes to the surface while in volcanic regions a few hundred feet is sufficient to sink our pipes.

Would it not pay municipalities to tap the earth's heat under foot and supply the city with heat, light and power at a good profit? Steam heat could be supplied to factories and householders for heating purposes at a low cost by running steam pipes underground. This, by the way, is quite practical altho not widely known. In New York, for instance, one large corporation supplies steam heat to consumers over an area of approximately 1½ miles square (2¼ square miles) thru fifteen miles of steam mains, but of course the heat is now obtained by burning coal first.

Our big states lacking coal and waterpower should certainly waste no time in trying Prince Ginori-Conti's plan. Such terrestrial heat plants will pay for themselves in two years or less.

H. GERNBACK.

THE ELECTRICAL EXPERIMENTER is published on the 15th of each month at 233 Fulton Street, New York. There are 12 numbers per year. Subscription price is \$1.50 a year in U. S. and possessions. Canada and foreign countries, \$2.00 a year. U. S. coin as well as U. S. stamps accepted (no foreign coins or stamps). Single copies, 15 cents each. A sample copy will be sent gratis on request. Checks and money orders should be drawn to order of THE EXPERIMENTER PUBLISHING CO., INC. If you change your address notify us promptly, in order that copies are not misrouted or lost. A green wrapper indicates expiration. No copies sent after expiration.

All communications and contributions to this journal should be addressed to: Editor, THE ELECTRICAL EXPERIMENTER, 233 Fulton Street, New

York. Unaccepted contributions cannot be returned unless full return postage has been included. ALL accepted contributions are paid for on publication. A special rate is paid for novel experiments; good photographs accompanying them are highly desirable.

THE ELECTRICAL EXPERIMENTER. Monthly. Entered as second-class matter at the New York Post Office, under Act of Congress of March 3, 1879. Title registered U. S. Patent Office. Copyright, 1917, by E. P. Co., Inc., New York. The contents of this magazine are copyrighted and must not be reproduced without giving full credit to the publication.

THE ELECTRICAL EXPERIMENTER is for sale at all newsstands in the United States and Canada; also at Brentano's, 37 Avenue de l'Opera, Paris.



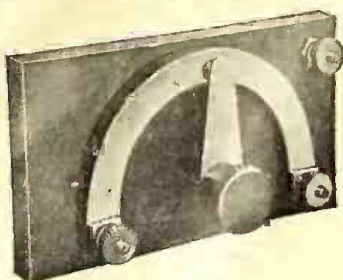

**GRAPHITE POTENTIOMETER**  
5000 ohms resistance insures long life to batteries. Carbon contact insures long life to instrument. Don't ruin batteries and instruments with inferior imitations.

**CHARGE STORAGE BATTERIES** from alternating current with the **BLITZEN RECTIFIER**. Safe, clean, economical.



**HIGH FREQUENCY, HIGH QUALITY TEST BUZZER**  
The smallest, neatest and highest pitched buzzer on the market.

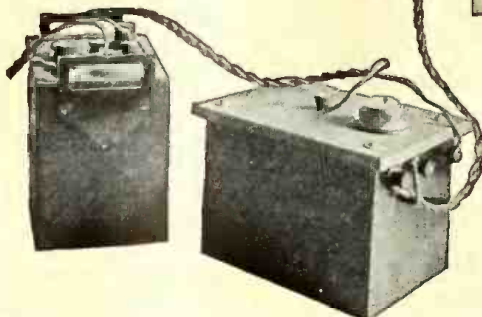

**ROTARY VARIABLE CONDENSER**  
Our small condensers, either 17 or 43 plates, are a little better value because a little better quality. Our catalog tells why.

**ONLY A FEW**

instruments selected from our new Catalogs can be shown here. Complete catalogs of Wireless and Electrical Apparatus, Storage Battery Chargers, Parts and Supplies sent for 6c stamps to defray postage.

**CLAPP-EASTHAM CO.**  
141 MAIN STREET CAMBRIDGE, MASS.

Western Representatives  
Southern California Electric Co. Berk Electric Co.  
625 S. Main St., Los Angeles, Calif. Portland, Oregon



**THE BLITZEN WAVE METER**  
A very attractive meter in portable form furnished in several types at a very moderate price. Mahogany case with hinged cover.

## DE FOREST RADIO TELEGRAPH AND TELEPHONE APPARATUS



**AUDION RECEIVING CABINET**  
TYPE RJ16—PRICE \$150.00

Incorporating in one cabinet the famous de Forest Audion-Ultraudion detector and special Audion Tuner. For spark and arc signals. Most efficient receiving set ever offered at less than \$500.00.

**T**HE value of radio equipment for motor cruisers and yachts is undeniable, both for the convenience of communicating and receiving intelligence under ordinary circumstances, and for its use in emergencies. But in either case the value is entirely dependent upon the quality and reliability of the instruments and apparatus of which the equipment is composed. de Forest Radio Apparatus is everywhere conceded to be the finest available for private use. It has been developed and refined through the persistent efforts of Dr. Lee de Forest and his staff until it has reached a degree of efficiency which cannot be expected in ordinary amateur apparatus. Used extensively by prominent yacht owners and by U. S. and foreign navies.

**WIRELESS TELEPHONES OPENS UP A NEW AND INTERESTING FIELD FOR THE BOAT OWNER**, requiring no special operator. Their perfection and practicability have been demonstrated beyond the shadow of a doubt.

Write for free bulletins or let us recommend radio apparatus suitable for your requirements.



**TYPE OJ3—\$400.00 COMPLETE**  
Oscillation Telegraph, capable of transmitting the voice 15 miles, or telegraphic messages 40 miles. Larger transmitters for greater ranges.

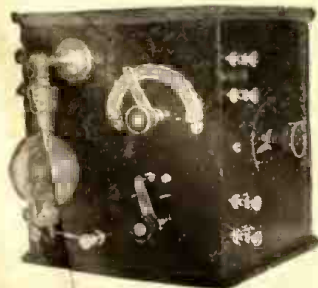

**COMBINATION AUDION-ULTRAUDION DETECTOR**  
TYPE UJ2—PRICE \$30.00.



**FAMOUS DE FOREST AUDION DETECTOR TYPE RJ8**  
Three to five times more sensitive than any other known form of detector. (U. S. Bureau of Standards Report.) PRICE \$25.00.

### DE FOREST RADIO TELEPHONE & TELEGRAPH CO.

1391 SEDGWICK AVENUE, NEW YORK CITY  
Sole Makers of the Genuine Audion, Oscillation and the Highest Grade Receiving Equipment in the World



**NEW AUDION AMPLIFIER FOR INCREASING STRENGTH OF RECEIVED SIGNALS 25 TIMES.**  
TYPE EJ2—PRICE \$32.00.

You benefit by mentioning "The Electrical Experimenter" when writing to advertisers.





# THE ELECTRICAL EXPERIMENTER

H. GERNSBACK EDITOR  
H. W. SECOR ASSOCIATE EDITOR

Vol. IV. Whole No. 47

MARCH, 1917

Number 11

## Volcano-electric Plant Develops 15,000 Horsepower

**T**HE ocean waves give promise of some day furnishing vast quantities of electric power, not to mention natural gas power plants, wind motors, and a host of other more or less available and controllable

rank folly to seriously consider such an undertaking, yet we have ever to face the facts and fact, remember, is often stranger than Fiction.

The actual harnessing of an Italian volcano to an electric generating station of

Prince Ginori-Conti on to his goal. As is well known, in Central Tuscany, near Volterra, there are numerous cracks in the ground, from which powerful jets of very hot steam spout high in the air with great violence and constancy, bringing up borac

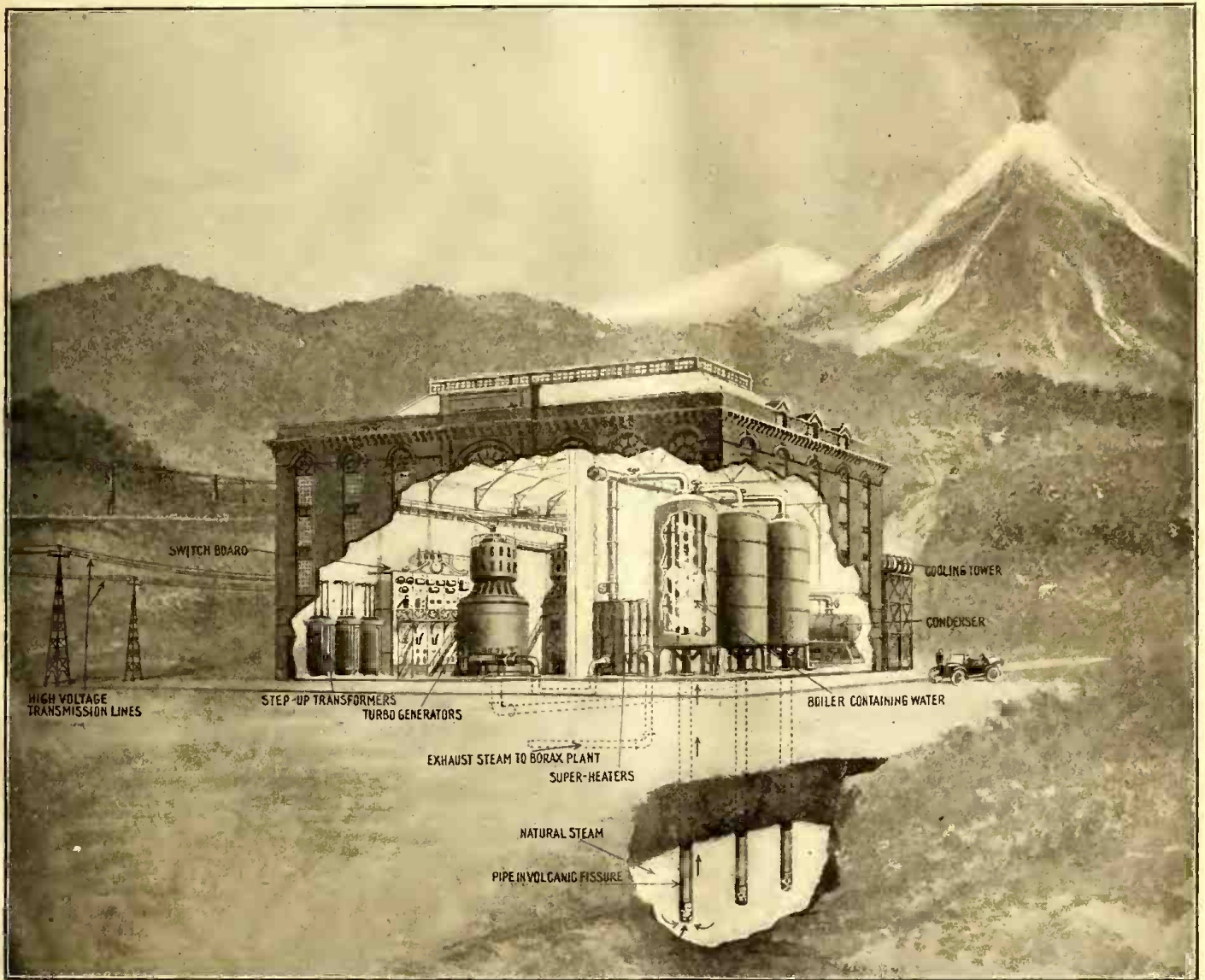

A Volcano-electric Plant Developing 15,000 Horsepower Is a Reality in Italy. This Plant, Now in Operation, Utilizes the Heat in the Natural Steam Present in the Ground Near the Volcano to Heat Water in Boilers. Steam from These Boilers Drives the Turbo-generators, the Electric Current Being Transmitted Many Miles Away.

sources of natural energy, but who would ever dream of harnessing a VOLCANO (or rather volcanic heat) to an electric generating plant developing thousands of horsepower? Verily, it would seem like

far-reaching usefulness is described by Professor Luigi in *Engineering* of London. The ever-increasing cost of coal in Italy was one of the principal incentives that ever goaded the brilliant and original

acid—which is very valuable—and other mineral substances of less importance. These powerful jets of superheated steam are called *Soffioni*—the *blowers*—and have been utilized for many years in the pro-



duction of boric acid and borax, and occasionally for warming the houses in the nearby village of Larderello. The larger proportion of the steam, however, is lost, having no local application, and with it is lost its very valuable heat.

Prince Ginori-Conti, the president of the Società Boracifera di Larderello, was the first, in 1903, to try to utilize this superheated steam for the production of motive power.

Elaborate experiments which were made very accurately demonstrate that each bore can provide steam at a temperature of at least 150 deg. C., and at the rate of from 15,000 to 25,000 kg. per hour, that is, practically, from about 1000 to 2000 theoretical horse-power per hour. Thus near Larderello there is the possibility of developing motive power up to thousands and thousands of horse-power. Encouraged by these results, Prince Ginori-Conti, in 1906, applied the steam to an ordinary steam engine of about forty horse-power.

The experience of several years has shown that this arrangement works well so far as the mechanical power of the steam is concerned, but that the borax salts and the gases mixed with the steam—especially sulfuretted hydrogen and traces of sulfuric acid—have a corrosive action on the iron parts of the engine and are the cause of frequent repairs. This difficulty was finally avoided by applying the superheater and afterwards used for driving but to a boiler; that is, by applying it instead of fuel to an ordinary multitubular boiler in which steam was produced at a pressure of two atmospheres, then past thru a superheater, and afterwards used for driving a 300 horse-power condensing steam turbine, directly connected with a three-phase electric generator, which supplies the works and the villages around Larderello. This installation had been at work quite successfully for several months when the present European war started. Then, coal becoming very scarce, and prices rising up to prohibitive limits, the possibility of using on a large scale this natural steam became very important.

Prince Ginori-Conti considered it his duty to carry out this trial on a large scale, availing himself of his long and successful experiments. Acting on the advice of the Tosi Works of Legnano—specialists in steam turbines and alternating current electric generators—he ordered three groups of condensing turbo-electric engines, each of 3,000 kw. (4,000 H.P.), working with superheated steam at  $1\frac{1}{2}$  atmospheres, generated in specially constructed multitubular boilers, the latter arranged vertically and with aluminum tubes, both for better utilization of the heat and better resistance to the corrosive action of the natural steam from the Soffioni. This steam, it should be noted, is used instead of combustible; it loses part of its heat in the boiler, reducing its temperature from 180 degrees C., to about 120 degrees C., and is then utilized for the borax industries.

The steam thus generated in the boilers and used for the turbines is *ordinary water steam*, which, on its way to the turbine, passes along aluminum pipes heated outside by a current of superheated natural steam at 180 degrees C., and thus gets in its turn superheated to about 150 degrees C. After passing thru the turbine this steam is discharged into a surface condenser, the circulating water of which is in its turn cooled in an ordinary cooling tower, as shown in our accompanying illustration. The condensed steam from the turbines is, of course, pumped back into the boilers, and thus no natural steam ever comes in contact

### MONSTER SEARCHLIGHT TO GUARD U.S. SHORES AGAINST AERIAL ATTACK.

A gigantic searchlight of 500,000,000 candlepower has been installed by the Government on the aviation field at Hempstead, L.I., N.Y., and it will shortly be put to tests to determine its worth as a *watchman* of our shores. Aviators will go up in bi-planes, followed by "enemies." The searchlight will then find the "enemies" and the other machines, hidden by darkness, will attack and destroy them. The light has a radius of four miles, sufficient, it is believed, to pick up a machine and keep it within its arc, while anti-aircraft guns and aeroplanes pick it out and destroy it. The accompanying photo shows the new searchlight as erected at Hempstead.

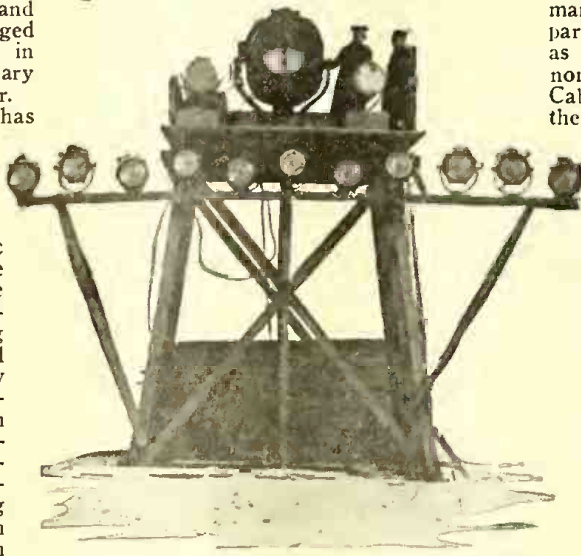

Photo Copyright by Central News Photo Service  
Gigantic 500,000,000 Candlepower Electric Searchlight Recently Erected at Hempstead, L. I., by the U. S. Government to Guard Against Hostile Aerial Attacks. It Has a Radius of Four Miles.

with the turbine; by this arrangement corrosion is completely avoided. This was the real and chief difficulty to be overcome.

The three-phase electric current is generated at 4500 volts and 50 cycles per second, stepped up thru an oil transformer to 36,000 volts, and sent along aerial conductors to Florence, Leghorn, Volterra, Grosseto and many smaller towns of Tuscany, to be principally used as motive power for munition works during daytime and partly for lighting purposes at night.

One of the 3000-kw. units has been at work since January, 1916, the second since April, and the third has just been started. So far, the first two groups have worked quite successfully and have been a great boon to the industries of Tuscany, greatly crippled by the scarcity and high price of coal. This very successful harnessing of volcanic heat to an electric power-house can be increased practically to hundreds of thousands of horsepower, as the region of *Soffioni* extends for many square miles around Larderello.

Thus we see how apparently uncontrollable forces of nature have been tamed and harnessed to do the work of man. In America we are still in command of large coal deposits, but hydro-electric developments are fast becoming a highly profitable and paying investment. But when these have reached their limit, we may have to look to the ocean waves, and yet again future generations may witness the sight of electric power plants deriving their energy from the heat of the earth thru long steel pipes sunk down thousands of feet. In the light of modern science it seems possible.

### COUNCIL OF NATIONAL DEFENSE.

In an act making appropriations for the support of the Army for the fiscal year 1917, Congress established a *Council of National Defense* for the coordination of industry and resources for the national security and welfare, and designates the Secretary of the Navy as a member thereof. It is contemplated that this council will eventually take over the work of industrial preparedness now being done by the Naval Consulting Board, and arrange it in such form as to be available to all departments of the Government in time of emergency. The excellent work already done by the Naval Consulting Board has been recognized by the President in the appointment of Mr. Howard A. Coffin, chairman of the committee on industrial preparedness of the Naval Consulting Board, as a member of the advisory commission nominated by the council composed of Cabinet officers. The act provides that the advisory commission be composed of seven persons, each of whom shall have special knowledge of some industry, public utility, or the development of some natural resource or be otherwise specially qualified for the performance of duties thereafter provided, and also provides that the special knowledge of such commission may be developed by suitable investigation, research and inquiry, and made available for the use of the council. It is also stated that the work of the *Council of National Defense* will consist in the coordination of military, industrial, and commercial purposes; in the reclamation of highways, railroads, utilization of waterways, and employment of military and naval resources for defense; and the increase of domestic production of articles and material essential to the support of the population, both military and civilian, in time of war. The superiority of the foreign military machines is directly traceable to such co-operation.

### WIRELESS 'PHONE FOR HOTEL PLAN.

Guests at the Hotel Oakland, of Oakland, Cal., may be able to talk by wireless telephone with friends on incoming steamers, if present plans under consideration by the hotel management are carried out.

Following the precedent by many hotels on the Atlantic coast, of installing wireless telegraphic sets for the benefit of guests, the management some time ago took up the feasibility of having a similar service installed in the Hotel Oakland, to be operated in conjunction with the ocean liners.

Recent negotiations by the federal government with certain interests who have been developing the wireless telephone for direct communication over the air route, together with experiments which Uncle Sam has been conducting with radio-telephonic systems, has led to the decision on the part of the manager, Mr. Carl Sword, to consider the practicability of having a wireless telephone establish in the hotel.

The plan includes a co-operation among hotel managers all along the Pacific Coast for the purpose. A regular service for the transmission of important inter-hotel business, advance reservations by guests over the air, and a thousand other uses could be found for the convenience. The plan was suggested at the national meeting of the Hotel Men's Association held last year, but no active steps were taken.

Under the plan, as outlined at the present time, the various hotel managers of the coast would form a wireless association which would install apparatus.



# 20,000 Leagues Under the Sea

**O**NE of the most spectacular motion picture features produced lately is the dramatization of Jules Verne's "Twenty Thousand Leagues Under the Sea."

For many years attempts have been made to reproduce this masterpiece on the stage as well as by motion picture reproduction. However, science had not developed far enough, until quite recently, and hence all previous attempts failed. Only a short time ago, due to the several inventions of the well-known Williamson Brothers, has it been possible to actually take moving pictures under the sea, and the present picture is a direct result of the Williamson Brothers' untiring work along these lines.

It is well known that forty-seven years ago, when Jules Verne wrote his book in which he prophesied the submarine down to

The story opens with Uncle Sam, about the time of the American Civil War, sending out a frigate to destroy a certain "sea monster" which had been reported from time to time in the various oceans, and which monster had supposedly done great damage to shipping. No one had been able to kill the supposed monster and for that reason the American frigate manned by a capable crew as well as by several adventurous people including the

oners by Capt. Nemo and upon their promise never to leave the undersea boat, they are accorded the freedom of the ship. The name of the strange craft is the *Nautilus* and this original boat has been carefully reproduced by the moving picture people at



Above:—Captain Nemo and His Doughty Crew Aboard the Submarine "Nautilus," Made Famous by Jules Verne in His "20,000 Leagues Under the Sea," and Now Reproduced in the Latest "Movie" Bearing that Name.  
 Left:—Here We See Several Members of the Crew of the "Nautilus" Emerging Thru a Sea Drop Door to Walk on the Sea-bottom. Note the Comprest Air Guns.

Below:—Sailors From the "Nautilus" Have Here Caught a Gigantic Turtle. The Men Carry Independent Comprest Air Tanks on Their Backs.



the most minute details, he met with quite a good deal of ridicule, due to the fact that the world at that time had not advanced far enough to appreciate his efforts. It is the old story of a man ahead of his time showing the world something which as yet exists only in his own imagination.

The new film which is now being shown all over the country and which has cost over a quarter of a million dollars to produce, is undoubtedly one of the greatest spectacles ever put before the public.

While of course it has not been possible to show the entire action as laid down by Jules Verne, it is surprising how close the picture people came to reproducing Jules Verne's idea in its entirety. While it was necessary here and there to embellish the story with new ideas, this has been accomplished in a clever manner all the way thru. There have been some additions which might have remained out of the picture, as, for instance, the firing of the torpedo which Jules Verne had not provided for in his *Nautilus*.

French Professor M. Aronax, was sent out to effectively deal with the new terror. When the frigate finally meets the supposed sea monster all efforts to kill it are of no avail, but to the contrary the monster rams the ship, pitching M. Aronax and his companions into the sea. When they come to their senses, they find themselves on the back of the monster, which they discover is made of steel, this being the famous Jules Verne's submarine, commanded by the mysterious Capt. Nemo, who supposedly has a grudge against humanity and has sworn not to return to land but roam the seas until his end. M. Aronax and his companions are made pris-

great expense and regard for details. Capt. Nemo, the main character of the story, is shown in one of our photographs with his crew on the deck of the *Nautilus*. The latter, constructed by the Williamson Brothers, is in itself a thoroly seafaring machine, equipt with all the various kinds of air tanks for submerging and raising it, and is propelled by powerful motors equipt with storage batteries. As mentioned be-

(Continued on page 831)



## Shooting Big Game on the Electric "Movie" Target

**T**HE motion picture camera has penetrated the distant jungles so often that it is the daily experience of the movie "fan" to fearlessly stalk big game across the screen; to see the Rocky Mountain goat cavort on the spot where Charlie Chaplin so lately fell, is now a common occurrence. The grizzly bear and the Bengal tiger are equally familiar to us.

is secured to enable the moving picture hunter to know whether his shots have gone true or not.

This effect was accomplished by the wonderful invention of Elliot Keen, an inventor of New York City. The basis of this device is a number of cast-iron balls hanging from a short piece of chain back of a steel screen, as seen in the upper right photo.

On the face of this steel screen the pic-

ture and one-half inches, electrically.

There are 33 wires stretched horizontally across the screen, evenly spaced, and 33 wires arranged vertically. At the many points where these wires cross are the contact-making balls. It will, therefore, be seen that a bullet striking against the target will connect certain two wires and as the latitude and longitude lines upon the map enable us to establish exactly any given

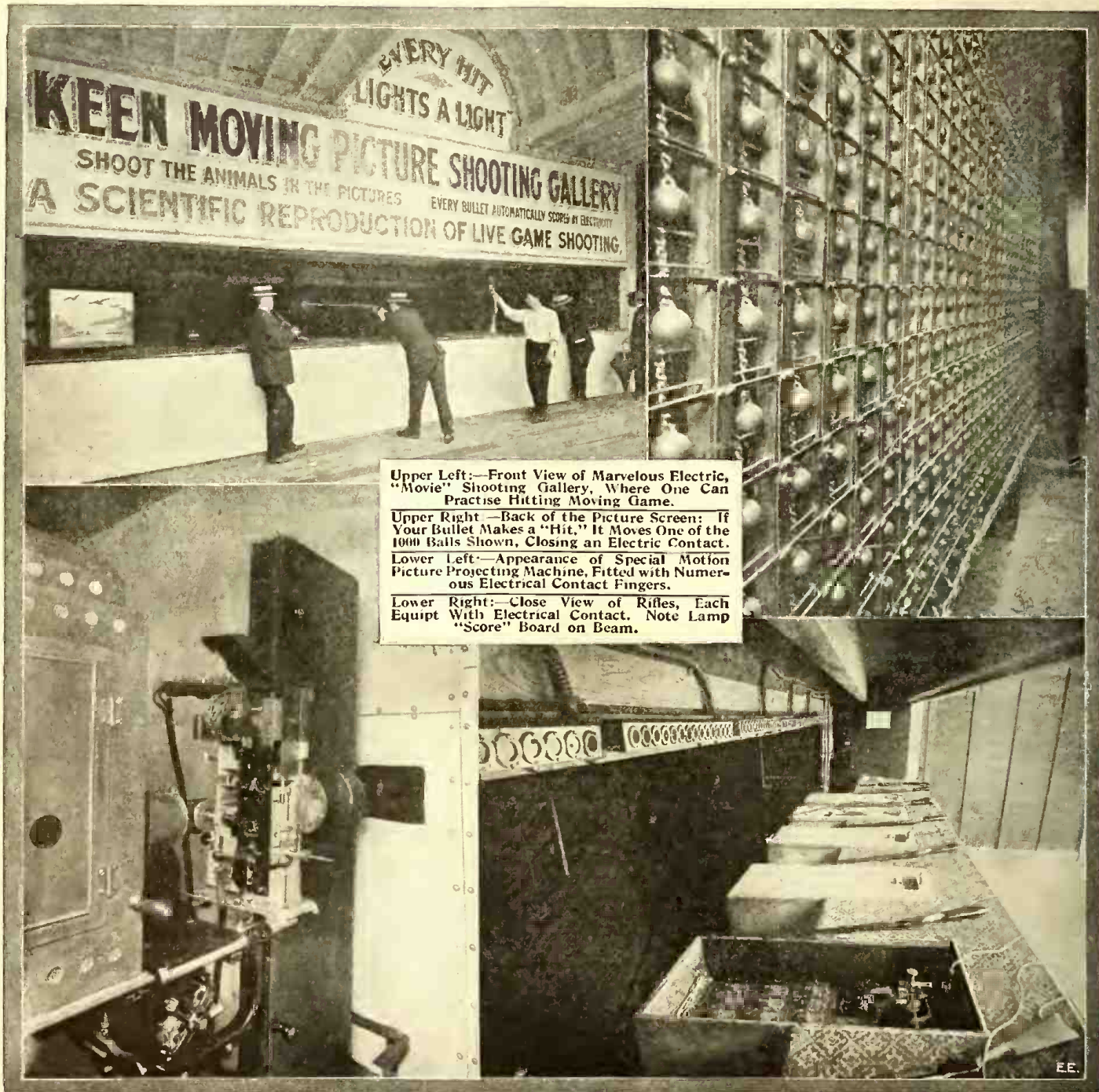

Upper Left:—Front View of Marvelous Electric, "Movie" Shooting Gallery, Where One Can Practise Hitting Moving Game.

Upper Right:—Back of the Picture Screen: If Your Bullet Makes a "Hit," It Moves One of the 1000 Balls Shown, Closing an Electric Contact.

Lower Left:—Appearance of Special Motion Picture Projecting Machine, Fitted with Numerous Electrical Contact Fingers.

Lower Right:—Close View of Rifles, Each Equip With Electrical Contact. Note Lamp "Score" Board on Beam.

It was therefore inevitable that some one should supply the missing link, so that the big game hunter, or even the amateur marksman, could continue his sport, using the pictured game for his target.

It is a very simple matter to take a steel screen and, painting it white, throw a picture upon it and then with a rifle shoot at the animal moving in the picture. But there is little satisfaction in this until some means

is thrown from a regulation moving picture projection machine. Each ball is so arranged that when the bullet strikes on the opposite side of the screen the ball makes an electrical contact and so identifies itself on an annunciator.

There are about one thousand of these balls behind the screen. The balls are so placed that the location of the point of impact of the bullet is established within

location, so the connecting of one vertical and one horizontal wire establishes accurately the point where the bullet struck upon the steel screen.

It is evident that if only those wires which cross beneath the picture of the animal be connected with the battery then stray bullets will be ineffective.

If for a moment we consider the bird in the picture as not moving and shown ex-



actly in the center of the screen, it will be easily seen that the sixteenth wire horizontally, and the sixteenth wire vertically, must be connected with the battery in series with the bell or signal. The bullet, directed by the marksman and which hits the bird, will actuate the suspended ball and close the circuit between these two wires, thus completing the circuit momentarily so that the signal indicating a *hit* will be given. This is accomplished by means of a lamp, placed in front of the gallery as seen in the lower right view.

When the bird starts to move the illusion will be produced by the movement of the film, or the situation which existed in the still picture will be changed every sixteenth of a second. Therefore, some means must be provided to connect the proper two wires with the battery for each location established by each picture passing thru the machine.

To accomplish this the film is perforated before being used in the gallery, while on the projecting machine there are arranged a number of fingers, operated by a cam to drop upon the film during the period when the picture is shown on the screen. These fingers are raised to permit the film to move. When the film comes to rest and the steel fingers drop upon it, two of the fingers pass thru the previously made perforations and thus connect the two essential wires to the battery. This part of the projecting machine can be seen in the lower left photo.

During the period when the picture is moving the bullet might, and likely does, strike the screen. It was, therefore, necessary to establish a secondary means of keeping the two proper wires alive, even tho the screen was in the dark. To do this a number of relays were introduced, actu-

ated by a commutator connected with the projecting machine.

It will be seen, therefore, that with the device thus far described, a man shooting at this moving picture with a rifle would succeed in ringing the bell every time he hit the pictured image. Inasmuch as public shooting galleries oftentimes have several persons shooting at the same time confusion might result as to who made the hit when the *hit signal* sounded. Therefore a special device has been designed which keeps the scores of the individual marksman.

The basis of this device is a small contact placed on the rifle itself which is made when the trigger is pulled. This moves a brush electrically by means of an escapement over the terminals of a number of lamps. The other terminal or ground wire from the lamps is connected with the signal circuit, so that if the signal of a hit came at the exact period when the brush of the escapement released by the trigger was sweeping over the terminal of the lamp, the lamp would be lighted; if no signal came from the screen immediately after the trigger was pulled, then the brush would harmlessly sweep over the lamp terminal and the lamp would remain dark. A cord connects each rifle with the mechanism, and it has been found that six rifles can be fired simultaneously at a moving picture, with practically no error in the score, altho it will be evident that there is a short time element and if two rifles fire together and only one makes a hit, then both will receive credit. The upper left illustration shows the general arrangement of the electric shooting gallery as used in one of the amusement places in New York City.

The electric moving picture target simply

consists of one circuit which is broken in three places—one at the gun, one at the projection machine and one at the steel screen. If, when the trigger of the gun closes, one of these breaks and the bullet at the screen closes another of these breaks, the projecting machine closes the third by connecting the battery to the essential wires, then a *hit* has been made.

In spite of the fact that this is a somewhat complicated machine, having cost \$27,000 for its initial trial installation, it has been found to stand up very satisfactorily under practical use. The most bothersome feature has been found to be the inaccuracy of the film itself, which changes its dimensions when exposed to the strong arc light needed to project the picture.

To overcome this a very delicate framing device was installed which framed the fingers up and down to compensate for the contraction and expansion of the film and for the wear on the sprocket holes, etc.

To prove the accuracy of the device, the inventor has adopted a peculiar bullet, carrying in the point a small amount of flash light material. The action of this bullet is to show a flash of light, which identifies the exact point of contact, thus showing the gunner the exact position at which he has aimed.

To have these 33 horizontal wire terminals and the 33 vertical wire terminals each represented by a finger, or 66 steel fingers to be raised and lowered each sixteenth of a second upon the film, was found to be impractical, because of the fact a single picture on a moving picture film is but three-quarters of an inch wide and altho the horizontal fingers occupy one side of the film and the vertical fingers occupy the other side of the film, to place 66 such fin-

(Continued on page 851)

**"WIRELESS" MOVIES VERY POPULAR.**

The "Honor System" photo play produced by the William Fox Corporation and just recently released, foreshadowed last summer, in its first presentation, remarkable achievements in the scientific field, which have since come to pass.

Wireless communication between the United States and Japan, which has already been effected, was foreshadowed in this presentation, and scenes were taken showing the imaginary wireless feat in progress.

The story runs thus—Joseph Stanton, a wireless inventor, who has been a student of electricity for many years; is the hero. It is his dream to effect wireless communication between the United States and Japan, and, indeed, this did prove, later, one of his crowning achievements. The part is played admirably by

Milton Sills, who is himself a scientist of considerable attainment, and a graduate of the University of Chicago.

We are introduced to wireless apparatus, of the hero's own make, which, tho capable of transmitting but a short distance, is equipt to receive messages within a

radius of many thousands of miles.

We quote Mr. Sill's amusing remarks:

"As a kid," says Mr. Sills, "I had two

"I guess it was a sort of 'call of the spark.'

"When I was eleven—that was in 1893

—the World's Fair was held in Chicago. Dr. Charles P. Steinmetz, the electrical wizard, delivered an address in one of the buildings, and concluded with an offer to answer any questions put to him by the audience.

"I asked the first and was so bent on getting more information on my pet hobby that I just refused to let up and put one query after another to him. Those in the audience must have felt that I was a nuisance at first, but I suppose they gradually came to understand that it was just my enthusiasm.

"Steinmetz finally laughed and said from the platform that he would be glad to spend an evening with me. Then he walked right down the aisle to where I sat and shook hands with me."

The film play proceeds further into various interesting episodes, but ends quite touchingly. Near the close of the inventor's career, he meets with an accident which blinds him forever. And we get a last glimpse of him with his sweetheart reading to him.



A Thoughtful Moment From the Film-Drama "Honor System"—in Which the Scientist-Hero Becomes Blind Thru His Radio Researches.

inseparable companions. The father of one was a lineman for a telephone company and the father of the other was superintendent of a big power house.

"The whir of the electrically propelled machinery just seemed to get into my system.



# Traveling at 500 Miles Per Hour in the Future Electric Railway

**A**N electric railway over which cars will fly at the astonishing speed of 500 miles per hour, or at the rate of 8.3 miles per minute, is one of the scientific possibilities of the day and one which is engrossing some of the master engineering minds of two continents.

An electric railway having such possibilities was broached by Professor Boris Petrovich Weinberg, Instructor in Mechanical Engineering at the Imperial University of Petrograd, Russia, at the recent New York meeting of the American Association for the Advancement of Science. Professor Weinberg has even built a model of his proposed 500 mile per hour electric railway; but the first difficulty met with in considering his really remarkable invention is that the cars are supposed to be shot thru a tube in which there is created a partial vacuum.

It would seem quite prohibitive, at least with our present understanding of such engineering matters, to build even a relatively small railway of this type and capable of maintaining such a speed as 500 miles per hour where the cars would have to pass thru an evacuated tube or tunnel, even if this were divided into short sections or locks, so as to reduce the total quantity of air that would have to be pumped out of the tunnel at a given instant. If we had available to-day a system extending from New York to San Francisco and on which the cars traveled at the rate of 500 miles per hour, then the trip between the great Metropolis of the East and the Golden Gate could be made in five hours. In other words one could breakfast in New York and lunch in 'Frisco!

Many other remarkable possibilities of such a railway system will immediately suggest themselves to the reader.

The editors of this journal have evolved a system for ultra high speed railway locomotion, such as 500 miles per hour, and which has been portrayed vividly by the well-known artist, Mr. George Wall, on our front cover. This system does not involve any such hyper-scientific proposition as that requiring an evacuated tube thru which the cars are to pass, but, instead, brings into play the rather slightly known method of eliminating friction by *electro-magnetic levitation*, on the principle developed to some extent a few years ago by one Emile Bachelet, formerly of Mt. Vernon, N.Y., but now engaged in research work in England.

The underlying principle of *electro-magnetic levitation*, as followed out by the Bachelet floating railway system, is readily understood by referring to Fig. 1 herewith. Here we have an electro-magnet coil M and an aluminum ring R. Now, if we

pass an alternating (rapidly changing from positive to negative and vice versa) current thru the magnet coil, it will produce, in turn, an alternating or constantly changing magnetic field. Such a field will repel sheets or rings of copper or aluminum, owing to the Eddy currents which are set up in them, the phase of these eddy currents being retarded by their self-induction. Hence, if we have an electro-mag-

in length, if it had to be equipt with such a series of closely spaced, powerful electro-magnet coils.

As is well known, it is possible to arrange an electro-magnet of proper proportions between two horizontal aluminum plates, and when excited by an alternating current, it will be found that the reaction of the magnetic flux set up will lift the magnet coil above the lower aluminum plate, and also cause the upper aluminum plate to be levitated, or raised above the coil.

Here is the germ of a revolutionary idea, viz., why not transpose the conditions in the Bachelet levitated railway system, and instead of lining the track with millions of dollars' worth of electro-magnets, simply place the levitated magnets within the car and construct the lower rail of properly spaced aluminum inductor sections?

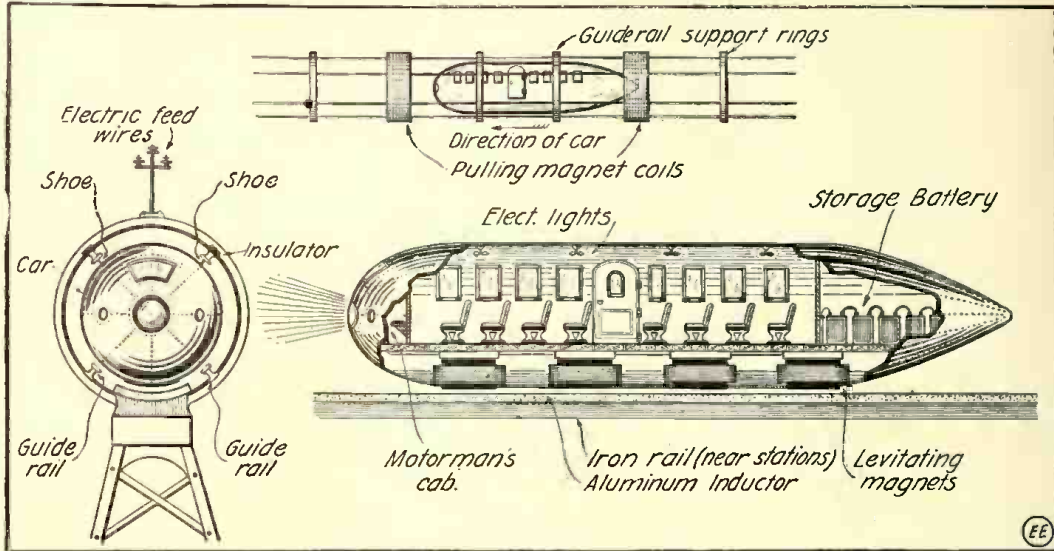

Fig. 2.—The 500 Mile Per Hour Electric Railway of the Future. Will Quite Likely Be of the Levitated Type, as Here Illustrated. Powerful Electro-Magnets Within the Car Raise It Above the Track, while Properly Spaced Solenoids Pull the Car Along.

net M, excited by an alternating current as in Fig. 1, and if we hold lightly an aluminum ring R, just above the pole of the magnet, we find that the alternating magnetic field will react in the manner just described, and forcibly repulse the ring upward, causing it to assume the position indicated by the dotted ring.

Again, if the aluminum ring is held by four cords and the alternating current past thru the magnet coil, the ring will remain floating in space above the magnet as shown.

In the Bachelet system of levitated locomotion, there is involved a fundamental disadvantage, which rapidly assumes alarming proportions when one comes to consider building a commercial railway of this type. This disadvantage lies in the fact that the cars, made of aluminum or having suitable aluminum inductor plates mounted under-

neath them, are intended to be levitated or raised into space, so as to eliminate mechanical friction between the cars and the track, by a contiguous series of powerful and expensive electro-magnets spaced evenly along the track and just below it.

By this means it becomes more feasible to construct such a levitated railway and at various points along the railway suitable ring-shaped solenoids or hollow tubular electro-magnets are placed to propel or pull the car forward. The accompanying diagram, Fig. 2, shows several details of the levitated electric railway which the editors believe would work out successfully, if the engineering details are properly taken care of. The car itself is patterned after the modern Zeppelin flying machine, having the front end in the form of a hyperbola and the rear end tapered off, so as to offer the least possible resistance to the air as the car shoots forward at the rate of 500 miles per hour. A series of powerful levitating electro-magnets are mounted under the floor and within the shell of the car as shown. A high tension alternating current is supplied over feed wires carried on cross arms at the top of the tubular track system, and this current could be taken into the car thru special contact shoes or wheels on either side of the car body; this alternating current being used to excite the levitating magnets for lifting the car from the track.

The road-bed is built up of a specially designed aluminum inductor rail, with a lower sub-rail of iron at station approaches. A small storage battery could be carried at the rear of the car so that in slowing down or stopping, and instead of exciting the levitating magnets with alternating current, they could be charged with direct current from the storage battery, and thus a greater frictional effect produced between the moving car and the rail. The flux from the electro-magnets within the car would, in this case, react on the iron sub-rail.

The car would be propelled forward in a manner similar to that of Bachelet's, or by

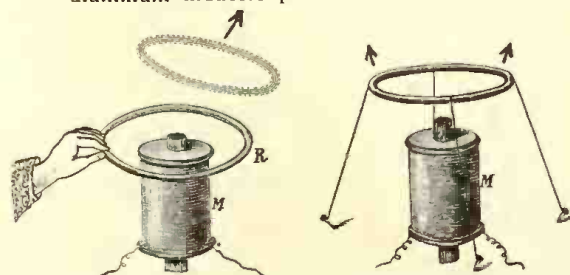

Fig. 1.—Demonstration of the Levitation Phenomenon Occurring When an Aluminum Ring Is Placed Over an Alternating Current Magnet M; the Ring R being Repelled Upward.

neath them, are intended to be levitated or raised into space, so as to eliminate mechanical friction between the cars and the track, by a contiguous series of powerful and expensive electro-magnets spaced evenly along the track and just below it.

It does not require a great deal of calculating to arrive at the conclusion that it would cost a small fortune to build such a railway even if it were only a few miles

(Continued on page 851)



# An Electric "Movie" Machine for the Home

ONE of the greatest objections to the standard type of motion picture machine for the individual user is that it employs a celluloid film with considerable expense attached thereto, as well as the fire danger of this inflammable article, thus barring it from use in homes, schools, etc. However, this has recently been overcome by a New York genius, Mr.

Hartwell Webb, who has spent a number of years in developing an entirely new motion picture apparatus. The limitations above cited are at once overcome by this new invention, which is based upon the fact that paper is cheaper and far safer than celluloid film; aside from this it will produce a motion picture of equal quality. It can be handled by a child as well as by a professional operator. For inflammable film exposed to the arc light, it substitutes paper films, exposed to the mild rays of the incandescent bulb light. For the expensive celluloid film it substitutes an inexpensive paper strip, involving no fire risk and which may be left about the house or shipped thru the mail.

The adoption of a paper tape or strip for projecting work necessitates the use of a somewhat different projecting machine, as the light cannot penetrate the paper film sufficiently to show the image clearly on the screen. Therefore, it was necessary to invent a new illuminating scheme for this kind of work, and it was not long before Mr. Webb evolved one which has proven very successful. One of the latest type of projecting machines is illustrated at Fig. 1. Its general construction is very similar to the present type moving picture machines, the only difference being that the film is illuminated as stated above.

By referring to the first photograph, it will be noted that the paper film is held on the top reel and is taken up on the lower one, when in operation. Similar gears are used for feeding this photo strip, as in an ordinary machine. The source of light is obtained from a number of incandescent electric bulbs, placed in reflectors and arranged in circular or ring form. This unit is placed in the circular chamber as seen at

the right. The face of the bulbs is directed towards the paper film so that the light falling upon it is reflected towards the projecting lens, which is stationed on the front of the chamber. A photograph showing the exact construction of the luminous unit is reproduced at Fig. 2. The central opening is used to permit the reflected picture to

the light is focused upon the postcard and reflected thru the lens. It will be noted that the general make-up of the projecting machine is just the reverse of the commercial ones used to-day. The light is focused on the picture in the opposite direction to the projected image, while the light of the present standard machine is focused in the

same direction as the projected screen image. Fig. 4 shows a

different type projector intended primarily for the home. The picture is focused on a transparent screen, the photo reel being operated by a motor.

The negative, which is the original photograph taken of the moving object, is first made on a regulation celluloid film and taken with a standard moving picture camera. The construction of the new instrument is very simple as seen from the accompanying photograph. Standard motion picture negative films are used, and the camera carries 100 feet of film, being so constructed that it may be loaded in broad daylight. The

film may be operated at will either by the usual hand-crank or by merely pressing a button, which closes

the circuit to a tiny, concealed electric motor, driven from dry batteries carried in the pocket of the operator. The connections are obtained by means of a flexible conductor, fitted with plug connectors at both ends. In this way it can be operated without a tripod, a great advantage in emergency use.

After the pictures have been photographed upon the film, the latter is developed in the usual manner and the print is made upon a sensitized paper strip, which is used in projecting the picture on the screen. A sample of such a paper strip is shown as a border about the photos herewith. The general make-up is about the same as for regular movie films with the difference cited above.

It is at once apparent how universal are the uses of this wonderfully developed camera intended for Mr. Everyman and his family. The amateur may take his own pictures, print and develop them in his dark room and project them on his parlor wall.

(Continued on page 831)

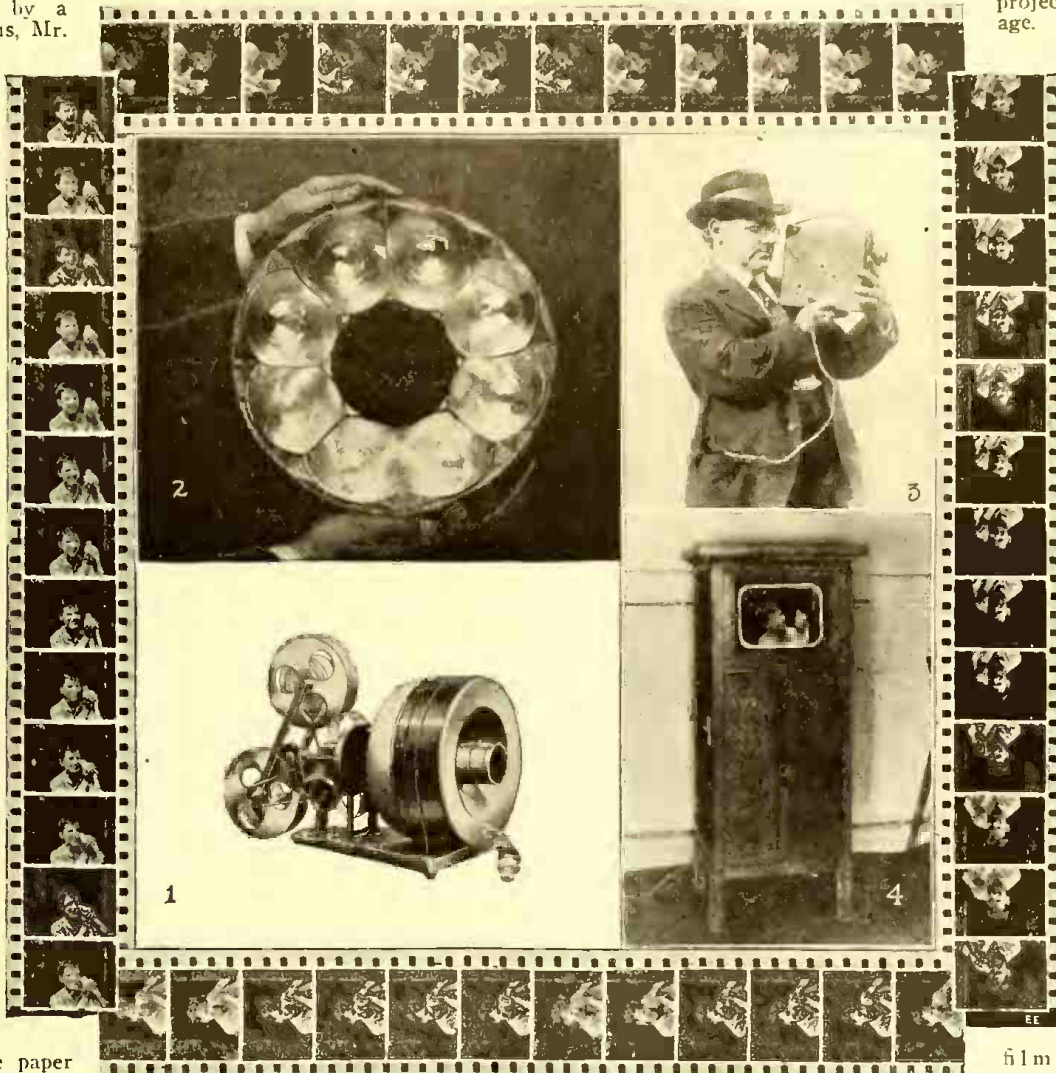

Illustrations Above Show: 1—the Projector; 2—the Lamp Ring; 3—the Camera; 4—"Home" Type of Projection Machine and 5—a Typical Strip of Paper Film (the Border).

pass thru and enter the projecting lens. The general operating principle of this machine

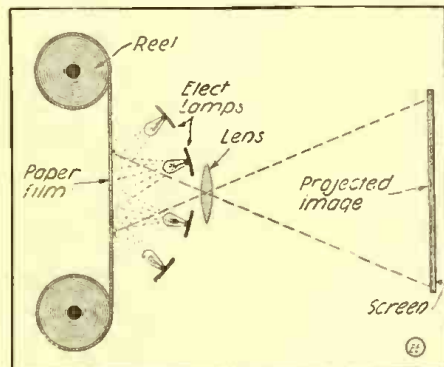

Diagram Showing How the Light is Reflected on the Paper Film, and the View Projected Thru the Lens Onto Screen.

is exactly the same as that of a postcard projector, with which we are all familiar,



**HOMEMADE ELECTRIC VAPOR BATH.**

Vapor baths and also plain sweat baths are often highly beneficial. If one provides a suitable rubber cloth (or blanket) cover to cover the body, as shown in the accompanying illustration, advantage may be taken of this treatment at small expense. First we may use the ordinary electric sad iron, suspending the iron on a hook beneath the chair. This will give the patient a good sweat. A toaster or other small electric stove will serve this purpose very nicely. By placing some medicating, vaporizing fluid in a small vessel and then heating this solution by immersing an electric water heater in it, a vapor bath will be had. It will be found extremely efficacious to employ one of the well-known *Vaporesol* devices for this purpose, which require but little current, while they rapidly vaporize, by electrolytic action, any kind of medicant or disinfectant.

Contributed by ALEX. K. CAMPBELL.



To Take a Vapor Bath at Home, All You Require Is an Electric Flatiron, a Vessel to Hold the Medicating Liquid and a Rubber or Other Blanket Arranged in the Manner Shown.

**THE PERISCOPE THAT IS INVISIBLE.**

THE submarine periscope is one of those small, yet all-important topics upon which naval officers have been wont to argue for some time; or, in fact, ever since the submarine has become an up-to-the-minute factor in naval warfare. One thing we know, and that is that the submarine is *running blind* when it begins to submerge so deep that its periscope disappears beneath the surface of the water.

It is often mentioned by naval people and others that, granting the point we have an *invisible* periscope; then with an observant officer on a torpedo boat, he will invariably catch sight of or *spot the white trail* made by the periscope in its course thru the water. Needless to say this has been the worry of more than one submarine officer.

But the periscope is not always moving, nor need it do so. It often happens (as recorded a number of times in the present war) that a submarine has been lying on the bottom of a bay or harbor for a number of hours, and arising, it becomes desirable to sight the bearings thru the periscope; in other words, there are many opportunities for using the periscope where, if it were *practically invisible*, it would render a submarine safe from attack by torpedo boats or scout cruisers, some of which can pounce down upon the sub-sea boat at a fifty-mile-an-hour speed.

About every imaginable manner of painting periscopes and submarine hulls has been tried out by the various Navies of the world. It was long considered that, if the structure of the submarine or ship could be painted with a certain splashy formation of sea blue and white, that it would very obligingly merge into the color scheme of the sea, and thus cause the periscope or

other part of the boat to become invisible at even short distances.

This, however, has been proven to be incorrect by no less a genius than Mr. Wm. A. Mackay, a mural decorator of New York City. Mr. Mackay recently delivered a lecture to the officers of the U.S.S. *Tallahassee*, and he explained his technique of rendering the periscope invisible in simple language. Said Mr. Mackay: "The thing to do, evidently, to make the periscope invisible, would be to paint that object the color that most resembled the water. But it seems that such is not the case.

If one takes up some of the sea water in his hand and examines it closely, he will at once perceive that it is not blue at all, but quite colorless and translucent—exactly similar to the water you drink from a spring or well. It has been ascertained by scientific analysis that the blue of the sea is composed of nothing more or less than *light*, and light is a combination of several primary colors. Under the peculiar conditions obtaining at sea, two of these colors combine and the resultant vibrations in the ether cause our brain to see blue. But this is not the blue that the artist paints on his canvas of an ocean scene. That is a paint—the other is simply radiant light so arranged in its vibratory combinations as to produce certain definite impressions of *color* on the optical machinery of the human brain.

To cut the story short, Mr. Mackay made up a checker-board affair, the alternate squares of which are painted green and violet. The vibrations of these two colors, when viewed jointly by the eye, would then attack the retina, and mixing, cause the brain to receive an impression of sea blue.

This remarkable scheme is shown in the

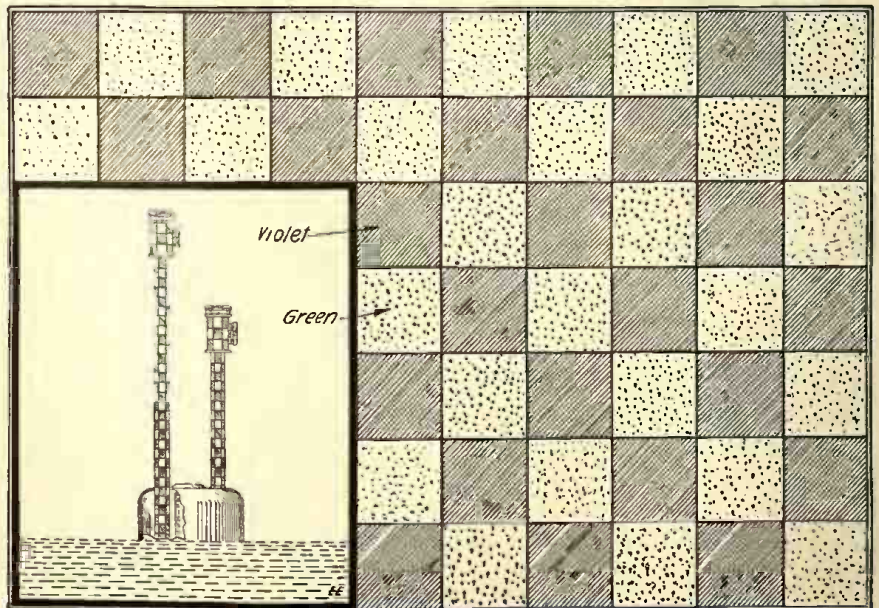

The Invisible Periscope Has Seemed to be an Elusive Myth, but an Artist-philosopher of New York Has Found That a Periscope Painted Checker-board Fashion, as Above, with Alternating Patches of Green and Violet, Will Become Invisible Even at Short Distances.

illustration herewith. If you have not forgotten how to dabble in water colors, try it out yourself. You may have to experiment

a little to get the right shades of (glaring) green and violet, but you will obtain surprising results eventually.

In demonstrating this wonderful scientific principle, Mr. Mackay took a large board which he had previously prepared, moved it to some distance from his guests, and held it up for their inspection. "What color does this board seem to be?" he asked. All were certain that it represented a beautiful *sea blue*. This *blue* board was then taken out on a boat some distance away and suspended above the deck, with the ocean as a background. It actually became invisible! Even t a short distance, not even an outline of it could be observed. Thus, if it had been the periscope of a submarine, it would have insured the crew and officers against attack, as surely as if they had been concealed under 50 fathoms of water.

After the performance the board which had appeared sea-blue to all was shown to the audience at close range. It was *not* sea-blue now, but it was painted in checker-board fashion in a vivid green and purple, as schematically indicated in our illustration.

**DANCED TO WIRELESS MUSIC SENT 31 MILES.**

Dancing to music transmitted by wireless was a novelty offered recently to guests at a house party in the home, in Morristown, N.J., of Theodore Gaty. The music was played in the laboratory of the de Forest Radio Company at Highbridge, New York, and was received at the Gaty home on an instrument so delicate that it has picked up radio signals sent from the German government station at Nauen.

The fox trots and waltzes played thirty-one miles from the Gaty home were made sufficiently loud by a special amplifying device. The plan was suggested after music sent from the de Forest laboratories had been heard by accident. Music has also come over the Gaty aerial from New Rochelle.

The receiver caught the sounds so distinctly that it recorded remarks of the sender and the grinding of the spring as the phonograph was wound.

Mr. Gaty and his two sons, one of whom



# How Electro-Pneumatic Tubes Shoot Mail Underground

**T**HE accompanying views show respectively a Monorail Car used in a newly devised 30-inch underground tubular railway; a view from the skeleton track of the tubular railway and the appearance of the pneumatic mail transportation tube terminals used in the Chicago General Post Office.

The rated power of the motor in the Monorail car is 4 horse-power. The car is designed for speeds between twenty and thirty miles per hour, but it is not limited to these speeds. With a motor of suitable capacity, the car can easily attain a speed of sixty miles per hour. As the system

supporting rail. The side rails act as guides only.

This automatically controlled electric railway has been designed to provide a means of underground or surface transportation which will have a larger capacity than a pneumatic tube. The system is automatic in its control. After a car or train is started it maintains a constant speed regardless of grades or curves. Before the train is started a mechanism is set on the first car, which indicates at what station the train is to stop. On approaching the station this indicating device causes the train to switch off the main track to a siding on which the station is

apart in the tube, and there will be ten carriers in transit per mile of tube. The initial air pressure is a constantly varying quantity which depends upon the length of the tube, the number of cars in transit at any given time, and other conditions. Speaking generally, however, we find that for a tube line about two miles in length, the initial air pressure would be approximately six pounds per square inch, or three pounds per mile of tube. This ratio, however, does not hold for any length of tube line, but is approximately true for the lengths of line ordinarily used in the post-office service.

The specifications of the United States

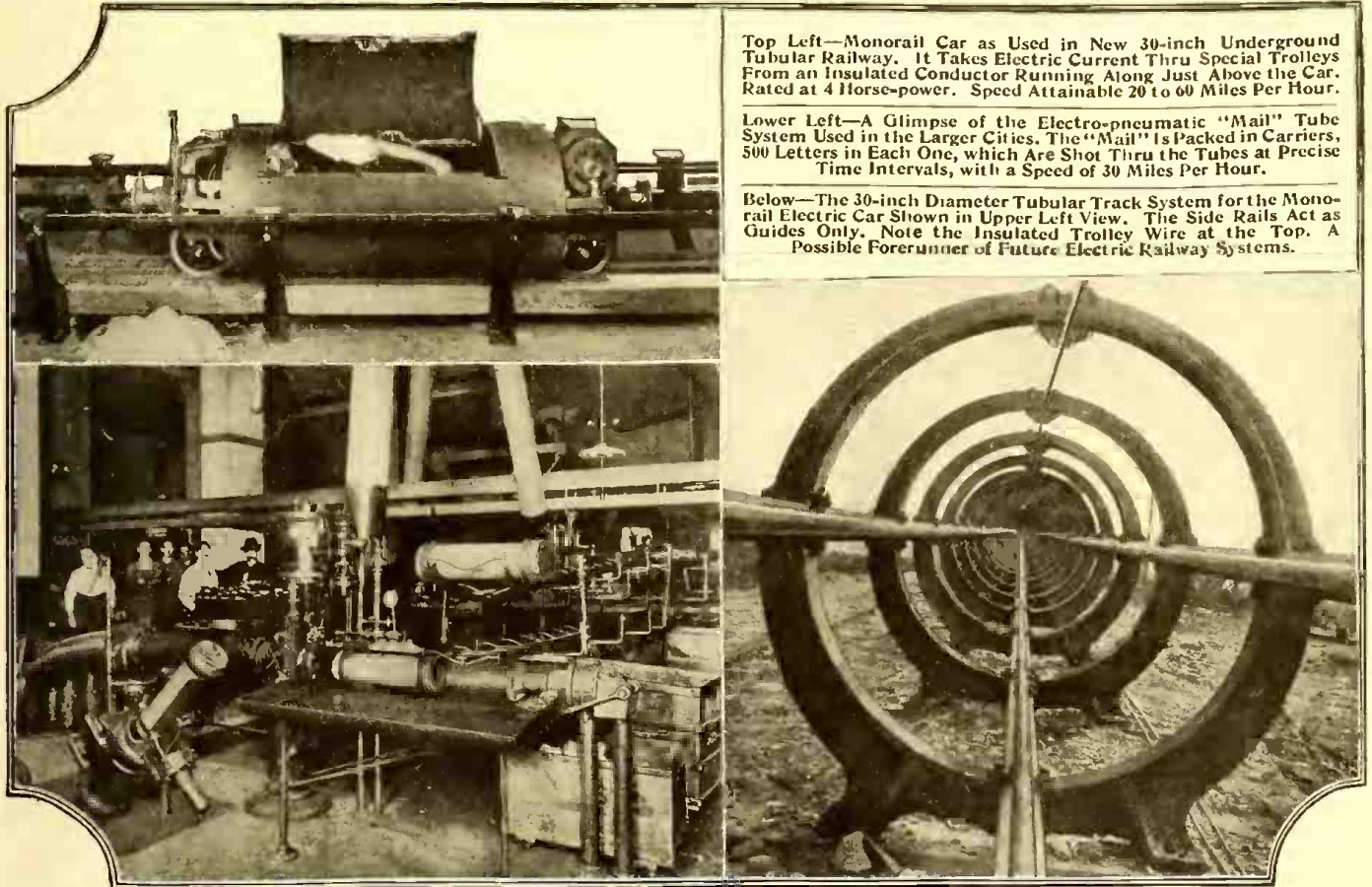

Top Left—Monorail Car as Used in New 30-inch Underground Tubular Railway. It Takes Electric Current Thru Special Trolleys From an Insulated Conductor Running Along Just Above the Car. Rated at 4 Horse-power. Speed Attainable 20 to 60 Miles Per Hour.

Lower Left—A Glimpse of the Electro-pneumatic "Mail" Tube System Used in the Larger Cities. The "Mail" Is Packed in Carriers, 500 Letters in Each One, which Are Shot Thru the Tubes at Precise Time Intervals, with a Speed of 30 Miles Per Hour.

Below—The 30-inch Diameter Tubular Track System for the Monorail Electric Car Shown in Upper Left View. The Side Rails Act as Guides Only. Note the Insulated Trolley Wire at the Top. A Possible Forerunner of Future Electric Railway Systems.

is designed, the cars can pass around curves of very short radius without danger of leaving the track. The thrust due to centrifugal force is taken directly by one or the other of the side rails.

The capacity of the Monorail car is well shown by the man lying in it. The construction of the car is also shown clearly. The car is 4 feet long and 25 inches in diameter inside. Externally it is 7 feet 3½ inches long, from buffer to buffer. The tunnel thru which it runs is 30 inches in diameter. Cars and tunnels can be made of any size adapted to the material to be transported.

The total length of the circular testing track at Cambridge, Mass., where the cars are tried out is 1,334 feet. The car travels around it at a speed of about twenty miles per hour, requiring about one minute to make the circuit, but this speed can be increased or diminished as desired by power controlling devices located in the station.

The current is led into the moving car thru T-shaped trolleys on the top, the current returning thru the bottom rail. The upper rail is, of course, insulated from the

located. The train quickly and positively stops itself when in the station by a special mechanism.

This system can be of any desired length. The size of the cars and the dimensions of the tunnels thru which they run may also be varied in order to provide for the different kinds of service. It is particularly suited for use under conditions where a pneumatic tube would be of insufficient capacity, and where a trolley system of the usual type with attendants on the cars would be too large.

Many of the larger cities are equip with pneumatic tubes, which connect the various post-office branches with one another. The mail, placed in special carriers, is shot thru the tubes by compressed air. This is supplied by electrically driven and controlled air compressors.

In these underground mail tubes, the carriers have a speed of about thirty miles per hour and are usually dispatched at minimum intervals, varying from ten to fifteen seconds. If dispatched in two minute intervals and traveling forty-four feet a second, they will be approximately 528 feet

Post Office Department, under which this pneumatic tube service is installed, call for tubes eight inches inside diameter. The carrier or traveling container, when inserted in the tube, is propelled at a speed of thirty miles an hour as stated above, and each carrier will hold 500 letters. The tubes can transport 200,000 letters an hour in either direction.

The Government experts estimate that every day 20,000,000 letters are advanced by the pneumatic tube service. Twenty-eight hundred carriers are constantly in motion traveling from one post-office station to another thru the pneumatic tube systems. The authorized mileage of pneumatic tube service in 1898 was but 16.2 miles, while in 1916 this figure had climbed to 113.2 miles. One thing about this system of transporting mail rapidly is that, there is never any blockage due to winter storms, or street congestion. The push of a button, the hiss of escaping air, and your letter, in company with 499 others equally important, is shooting along under the streets and rivers with express train velocity.



# Electricity and Life

By FREDERICK FINCH STRONG, M.D.

Lecturer on Electro-therapeutics, Tufts Medical School, Boston

**S**CIENTIFIC progress during the past three decades has perhaps surpassed that of all preceding ages; but we are still in the kindergarten class when we compare what is known with that which is still to be discovered.

To discover means practically the same as to uncover, implying that the truth or fact was there all the time but was hidden, covered, occluded, or occult, and is it not a fact that many of the electrical discoveries of to-day would have been regarded as supernatural or occult by the scientists of a few generations ago? Of course there is nothing supernatural in the strict sense of the term, but many things remain occult, altho science is daily uncovering new and hitherto undreamed-of marvels.

There exist great Cosmic Forces of which we still know but little. Gravitation is one of these; we know something of its laws and the results of its action, but nothing whatever of its real nature. Electricity is another; of this we know somewhat more, and we now recognize it in a variety of forms, as light, heat, chemical action, magnetism, etc., but its true nature is still a deep mystery. Life-force or vital energy is another great Cosmic Principle; thru its action electrons are formed into atoms, atoms into molecules, molecules into crystals and chemical compounds, and these into the bodies of plants, animals and of

nized this force; it is quite unorthodox to even suggest that it exists—simply because we have not been able to measure and record it by our still comparatively crude laboratory instruments.

A few years ago, when almost every sci-

and frequency during some research work. He prophesied that when electrical oscillations were fully understood and applied by physicians that a universal healing agent would have been obtained—one which would so increase the vital energy and resistive reaction of the human body as to enable it to throw off all disease. The present writer, acting on this hint, constructed a high-frequency apparatus, tested it on a number of patients and reported his results to a local medical society in 1895. So far as can be learned this was the first clinical work ever done with the Tesla Current, altho d'Arsonval in Paris was then experimenting with his relatively low voltage currents, produced from 3,000 cycle alternators. Later, Apostoli, Denoyes, and others reported remarkable results from the currents induced in the bodies of patients placed inside of huge solenoids or wire coils thru which high frequency currents were passing. The effects obtained were: increase of strength, appetite and weight, induction of natural restful sleep, and increase in tissue combustion and elimination.

Early in 1895 the author devised the first Vacuum electrodes for applying Tesla currents to the patient. Today thousands of physicians are using this device, often miscalling it the Violet-ray Treatment. This is of course a misnomer, the violet light in the tube having nothing whatever to do with the healing effect pro-



Demonstrating in a Startling Manner, the Appearance of the Human (the Author's) Body When Charged With a High Frequency Current. This Picture Shows Exactly How a Person Charged From a Powerful High Frequency Apparatus Would Appear to Our Unaided Eyes, Were They Attuned to Respond to Vibrations of One or Two Millions Per Second, Instead of From 380 to 760 Million—Millions Per Second (the Range of Normal Human Vision). This Display Greatly Resembles the Natural Aura Surrounding the Human Body, but which Average Persons Can See Only by Gazing Thru Special Chemical Screens.

entist was a materialist, we believed in nothing but matter and force; to-day science recognizes the necessity of a third basic principle, Intelligence or Mind; without this we can satisfactorily account for none of the facts of the world in which we find ourselves. Its manifestations in matter thru the Cosmic Forces give us at least a working hypothesis of life.

As electricity has been the great field for the investigations of the past century so will the nature and manifestation of the Life-force be the source of the discoveries of the future. Even to-day we may hazard a few statements regarding this hypothetical Prana or Vital-force. For example, it comes to us—like all other active forces—from the Sun. It is stored and transmitted by plants and by the oxygen of the air, and in the human body it appears to be distributed thru the great Sympathetic Nervous System to every organ and tissue of the body. The Sympathetic nerves radiate from the Solar Plexus—our Sun-center. If bacteria or poisons interfere with this circulation, as for example in infantile paralysis, the muscles from which the supply of life force is cut off, lose their power of reaction and wither away. It is in this connection that we may study the action of certain electric currents as applied to the treatment of disease. It would seem that certain types of alternating currents of high frequency and voltage greatly facilitate the distribution of this vital principle (Nerve-force, Prana, or whatever you choose to call it), and this explains the action of one of the most valuable of recent medical discoveries.

In 1893, Dr. Nikola Tesla described in a magazine article the remarkable effects upon himself and his assistants resulting from their exposure to the action of alternating currents of exceedingly high-voltage



Electrical Autograph of the Human Hand, Showing the Radiations from it When Charged with a Powerful High Frequency Current.

man. We have no name for this force, but thru its action the great Cosmic Scheme of Evolution goes on. In India they call it by a Sanscrit name—Prana. Here in the Occident we have not yet officially recog-

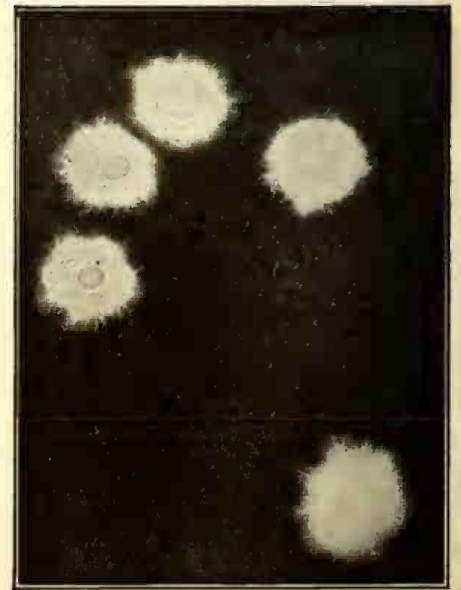

A Striking Electrical Autograph of the Tips of the Four Fingers and Thumb of the Author's Left Hand. A High Frequency Current Charged the Hand while It Rested on a Photograph Plate, With the Results Shown.

duced by the transmitted electrical oscillations.

(Continued on page 831)

See Cl. 250-33 for next page.



# Oxybenzylmethylen glycolanhydride

**W**ITH a cunning surpassing that of the alchemist of old, the modern chemist combines two strong-smelling liquids to form a solid that is utterly devoid of odor or taste. Under conditions known to that deft magician—the chemist—those two odorous and unpromising materials, carbolic acid (Phenol) and formaldehyde, unite and form a transparent, amber-like solid (Oxy-benzyl-methylen glycol-anhydride), better known as BAKELITE.

Bakelite is a condensation product of carbolic acid and formaldehyde. In its final form it is a hard, amber-like substance, having none of the chemical characteristics of the raw materials from which it is made.

Bakelite has no melting point, but at temperatures in excess of 575° F. (300°C.) gradually carbonizes and disintegrates. It is not merely a mixture, like compounds of rubber, shellac, or resin, which have characteristics of their components. Bakelite is an American invention, the process having been originated by Dr. L. H. Baekeland, already widely known by his discovery of so-called *gas-light* photographic papers, notably Velox.

Moulded Bakelite finds great favor in the electrical field as an insulating material—it is hard and strong, has great electrical resistance and successfully withstands high temperatures. Water, steam, oils, solvents and most chemicals have no detrimental effect on it.

Exactness of shape and size is characteristic of Bakelite moulded insulation. Every piece comes from the die exactly like every other piece; the edges and lines are sharp and clean and the piece fits in place as in interchangeable machine construction.

Because of its permanence and chemical inertness, this new insulator is the ideal material for electrical instrument construction. No acid-sulphur compounds are emitted as in the case of hard rubber, nor does Bakelite turn green, or bloom. The finish, too, is all that can be desired—it comes from the mould with a beautiful lustre and with every detail and relief sharp and clean; no buffing is necessary.

This remarkable insulation meets every requirement for moulding in metal inserts. The inserts are in to stay, securely and accurately positioned when the piece comes from the mould. To put metal inserts in hard rubber or fibre requires drilling, tapping, and fitting—slow and expensive processes. Moulded Bakelite can readily be machined and polished. Each of the standard colors—brown, red, and black—is rich and handsome in appearance.

Bakelite has many valuable qualities which make it especially suitable for mechanical pieces, sometimes made as die-castings. It is strong and light—weighing only about one-third as much as die-castings and has a specific gravity of 1.35. The beautiful finish is permanent; there is no enamel or other surface coating to wear off, no plating or japanning. It is more-

over extremely homogeneous, the same all the way thru. Unlike many die-cast alloys, Bakelite does not lose its mechanical strength nor deteriorate with age. In a critical time test with a gear made from Bakelite-Micarta driven by a steel pinion, practically no wear was evidenced after 20 months' service. The speed of the special gear varied from 560 to 1100 r. p. m.

The new insulation in the form of sheets, rods, and tubes is fast taking the place of hard rubber, fibre, pressboard, and similar materials. It combines high dielectric strength and heat resistance with unusual mechanical strength. It is hard, tough and homogeneous and fairly flexible. Supplied in sheets, rods and tubes of standard sizes it can readily be machined to any required form. Standard colors are brown and black.

Telephone apparatus has benefited greatly by the advent of Bakelite. The accompanying illustrations show a sectional view

Tensile Strength (average): 3700 to 4500 lbs. per sq. in.  
Colors: Dark brown, reddish brown and black.

An important form of the insulator is known commercially as Bakelite-Dilecto. This hard, marble-like material, which is much used for switch panels, especially on wireless sets where the very best of insulation is demanded, has an average dielectric strength of 700 to 1,150 volts per mil (1 mil equals .001 inch) according to thickness. The insulation value increases somewhat at temperatures up to 212° F. Sheets approximately 1/8 inch in thickness have been repeatedly tested in excess of 100,000 volts.

Bakelite-Dilecto will not expand, contract or soften under the influence of heat, even up to the point of carbonization. It is not inflammable, like hard rubber or resinous materials, but will eventually support combustion if brought into contact with a flame for any length of time. It will,

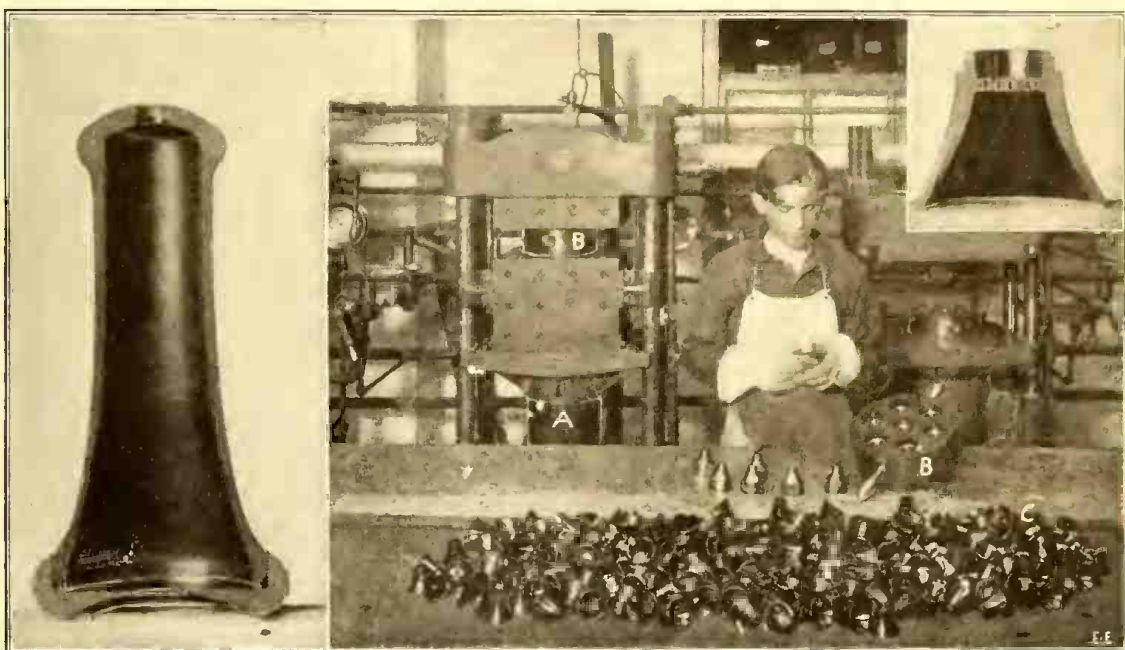

The Illustrations Show from Left to Right—Section of a Moulded "Bakelite" Telephone Receiver Shell; Process of Moulding "Bakelite" Transmitter Mouthpieces, "A" Being the Hydraulic Press and "B" the Multiple Moulding Die; Upper Picture Shows Section of a Mouthpiece.

of a Bakelite receiver shell as well as a section of transmitter mouthpiece. The machinery shown comprises powerful hydraulic presses which press the dies together and thus form the accurately shaped mouthpieces seen on the bench in front of the operative. Here "B" represents the die, "A" the hydraulic press, and "C" the moulded mouthpieces.

The new Bakelite receiver shell is without a doubt the most perfect receiver shell to-day. It is a great improvement over the old style hard rubber and composition shells and has none of the disadvantages of either. It will not turn green from age or lose its lustre. It will last indefinitely, which helps to reduce maintenance cost. Not only are the receiver shells made of this material but the mouthpieces and certain other parts are made of it as well. The mouthpieces can be washed and thoroughly sterilized as moisture, acids, or steam leave no effect on Bakelite.

The general physical properties of Bakelite moulded material are given below. They vary according to the composition used.

Specific Gravity: 1.33 to 1.89.  
Temperature Resistance: 300° F. to 400° F.  
Dielectric Strength (average): 250 to 425 volts per mil.

however, continuously withstand a temperature of 300° F. without deterioration. It cannot be moulded but is supplied in a number of special shapes for certain requirements, such as sheets, rods and tubes.

Regarding the insulation resistance of Bakelite-Dilecto, the following data will prove of interest.

**FOUR SAMPLES TESTED, 3.16 INCH THICK.**

Resistance of sample Megohms	Normal Condition	
	Specific insulation resistance per in. cube	Specific insulation resistance per cm. cube
1 37,000	530,000	1,350,000
2 30,000	440,000	1,110,000
3 29,500	425,000	1,080,000
4 29,000	420,000	1,070,000
After heating at 104° F. for 24 hours.		
1 260,000	3,700,000	9,500,000
2 102,000	1,500,000	3,800,000
3 190,000	3,750,000	7,000,000
4 128,000	1,850,000	4,700,000

It is vitally interesting to note the increased resistance at the higher temperature. (1 megohm equals 1,000,000 ohms.)

Comparison with ordinary and well-known insulators is the criterion that shows where Bakelite stands in the electrical world. Note the last column at the right in the above table and then note that:—Hard rubber shows 2,000,000 megohms per centimeter cube at normal temperature; mica, 3,000,000 megohms cm. cube, gutta

(Continued on page 851)



## Patriotism

**B**EFORE we go further, we might as well admit it. When it comes to front covers, THE ELECTRICAL EXPERIMENTER is on deck with a whoop. Whoop with a big W. As for noise—yes we don't deny it—our average cover designs, outnoise the biggest 1917 Model Klaxon. Now, of course, we fully realize that our cover de-

did you get yours when you 'created' that latest masterpiece."

Or else someone calls him on the wire and informs him that the S.P.C.A. threatens to have him arrested. "S.P.C.A." shouts the chief in the phone, "what in thunder have I done now to an animal?" "Animal my eye" chuckles the other party, "S.P.C.A. stands for Society for the Prevention of Cover Atrocities!!" and so on.

But we did not start out to tell you about all this; rather we wanted to say that our weirdest covers as a rule only draw favorable comments, presumably because they make people think, hence are really useful, despite the loud colors.

Now then our January cover was really a very artistic affair. One of the sanest as well as best executed covers we ever had. Being such, it goes without saying, that H.G. had *not* concocted it. Rather, a very eminent artist conceived and executed it, namely Mr. John A. Bazant. Yes, the same Bazant whose design won the 2nd prize of \$500 at the recent prize contest of the Society for Electrical Development where 800 paintings and drawings had been submitted to the judges.

Despite this, strange to say, our January cover called forth more unfavorable comment than any other cover we ever had. Beginning with the first day after publication, sarcastic letters began to pour in, asking us if we had ever seen the American flag painted backwards. Others wanted to know if the Germans would respect the Stripes and Stars, being that this was a brand new kind of flag. Still others lambasted us with the argument that the flag made for *backward* neutrality!

Of course all these good people were wrong. Moreover they probably were "landlubbers." For the flag is painted right. Just imagine a flagpole on the flag, the whole set in the bow of the ship. Will it not then appear exactly as Mr. Bazant painted it. You see when you look at the starboard side of a moving ship, any flying flag of the Stars and Stripes appears backwards.

The next surprise came from Boston, Mass. As a matter of fact, there were quite a good many from Massachusetts.irate readers wanted to know what we meant by pasting Santa Claus and other paper stickers over the United States flag, thus hiding it. Since when are we ashamed of our Flag, and if we did print it, why did we cover it up? The argument was perfectly logical and was backed by facts.

Our illustration of a copy of the "E. E." sent to us from Boston proves it amply.

Alas, these good people who thus wrote us wrathfully, did not know the patriotic laws of their fair and enlightened state.

For, gentle reader, in case you have not heard of it before, Massachusetts, a most learned and civilized state of these United States has among others a cute little law which forbids all Lumanity and others from openly selling any object whatsoever on which the Stars and Stripes are displayed. Whether the object be a Magazine, or a Bible, or a box of cheese, matters little. Don't ever dare to put such objects in a window display. The Massachusetts police will make you take it out or else arrest you. Pretty little idea that, to create patriotism in one's breast. And all this in highbrow Mass!

But perhaps you don't get the correct "drift" from our prose. For that reason we are moved to poetry which will make everything plain as a plane:

### MASSACHUSETTS FLAG SONG

~ramp, tramp march the Cops  
Licking their chops.  
All is hunkydory,  
If you hide Old Glory.  
But don't wag,  
The Old Flag.  
If you do  
Woe to you.  
Says the cop:  
"Now you stop  
If the flag is here on sale,  
You must go to jail.  
If the flag is on your Bible,  
You'll be pinched for libel  
If the flag is on a postcard  
Or if it's on the go-cart.  
If the flag is here on sale,  
Come with us to jail.  
If the flag is on a postage stamp,  
Or if it's on your auto lamp,  
Perhaps it's on your letterhead,  
Or printed on your cigarette  
If the flag is here for sale,  
You'll be put to jail.  
If the flag is in your straw-hat,  
Or if it's on your baseball bat,  
If on baby's sand tin-pail,  
Rightaway you go to jail.  
If it's pressed into your soap,  
Or on the label of your "dope"  
If it's on ten dollar bills  
Or on a box of bitter pills  
If the flag is here on sale,  
Pay the kale or go to jail.  
That's the law in dear old Mass  
Come along, you're pinched, my lass.

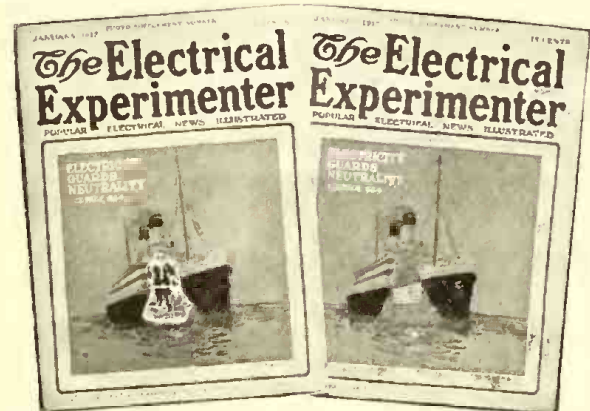

Pasting Santa Claus Stickers Over the Stars and Stripes Is Not a New Fad. Nor a New Christmas Wrinkle in Dear Old Massachusetts. It's the Law. Goods Displaying Our Flag May Not Be Sold in This State.

signs are loud and are trying their level best to outshriek all other noisy covers on the crowded news stands. But you buy them, don't you? So do thousands of others every month who had never before heard of the magazine. They are attracted by the bright sometimes screaming colors. If at all interested, the net result is a new reader. As the bulk of our readers are news stand buyers, it naturally follows that we wish to attract the greatest possible amount. Our covers seem to accomplish this successfully, it would seem so, for in three short years THE ELECTRICAL EXPERIMENTER has reached a circulation of 73,000 copies, larger by far than that of any other two electrical periodicals combined.

So you see that the Editor's main and staple vice—E.E. Front Covers—is pardonable. He lays awake nights waiting for inspirations (or shall we say conspirations) and given six good ideas he will pick out the most startling one. Being that all the "good" ones strike him between 12 A.M. and 4 A.M. his friends, when out of ear-shot (as well as other shot) call the ideas nightmares! When a particularly "hot" one makes its first appearance by setting fire to the news stands, intimate friends are wont to call around at the Chief's office with such comments as: "Listen H.G. what dope do you take now before going to bed?" or "I thought opium smoking was taboo; where

### UNIQUE ELECTRIC TOY ENGINE.

A unique electric toy engine of exceptional power has been developed recently by Mr. Thomas H. Phillips and is shown herewith.)

The general construction of this miniature prime-mover, so dear to every boy's heart, is quite different from any of those with which we are already familiar, i.e., a pure solenoid action is utilized in this machine similar to an actual steam engine, whereas the others employ ordinary solid core magnets acting inefficiently upon a flat iron armature. Another feature of this engine is that it has no dead center and will start every time, irrespective of the position of the connecting rods and crank shaft.

It consists of two solenoids, each of which contain two coils, wound side by side, but separated from each other by an insulating washer. The cylinder is made from brass tubing and fitted with iron rods

constituting the pistons which are joined to the flywheel shaft by means of connecting rods.

The four coils which make up the two main solenoids are connected in such a manner that each one of them act upon the piston at certain definite periods. The two forward coils are connected in series and their terminals linked to the battery binding posts of the engine. The remaining four wires terminating from each coil are connected to a set of four fixt segments, which are placed on the left hand shaft support. These are made from brass and placed in circular order. The shaft carries a brush which plays over this fixt commutator, so as to connect the necessary coils progressively to produce rotary motion of the shaft. The connection to this brush is made thru the frame of the engine.

The operation of the engine is very sim-

ple and it depends upon the electro-magnetic suction of the coils upon the iron



A New Toy Electric Engine with Double Wound Coils, That Is Extremely Powerful.

pistons. This is of course accomplished by the manner in which the coils are connected to the fixt commutator. The engine runs very fast on a single dry cell.



**A NEW OZONE MACHINE OF MANY USES.**

The ozone machine shown herewith consists of a main frame of preferably aluminum, constructed with annular end pieces

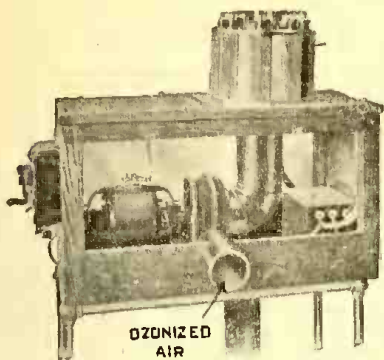

OZONIZED AIR

Ozone Machine for Alternating or Direct Current. A High Tension Transformer Discharge Produces the Ozone, which is Blown Out Into the Room by a Motor-driven Fan.

which are provided with slots extending inwardly from the periphery of the rings toward their centers. These annular end pieces or rings are held together by longitudinal bars. A series of comb-like electrodes are arranged to fit in the slots. The electrodes consist of a strip of conducting material, and have a series of laterally extending teeth. When these electrodes are placed in the slots the ends of the teeth will lie in the same distance from the center of the rings. The electrodes are held in place by means of rings which fit over the annular end pieces. The dielectric is a thin glass tube. Within the tube, at a short distance from each end, is an insulating washer. On each end of the tube is a cap made of insulating material. Between the washers the tube is filled with a finely-powdered conducting material. A metal conducting rod extends thru the tube from end to end, with the ends of the rod threaded to receive nuts which hold the caps in place. The rod forms one terminal, to which one pole of a high tension transformer is attached, the other pole being connected with the frame which holds the electrodes. The dielectric prevents sparking between the teeth and the electrodes and the conducting material, but it permits a static discharge thru the glass in the form of a glow or fine brush. The ozone produced is blown out into the room only by a motor-driven fan of special construction.

**AIRSHIPS USE WIRELESS SUCCESSFULLY, SAYS MARCONI.**

Upon his return to London from Italy, Dr. Guglielmo Marconi, in an interview with British journalists, gave the following information: "New developments will not only make wireless communication in this war more efficient than ever before, but will make it more difficult for the enemy to intercept messages. These improvements will apply to instruments in aeroplanes and airships. Hitherto aeroplanes have been at a disadvantage with airships in wireless work, for although they were able to transmit messages, they have not been able to receive them. This was because the received signal was too faint to be distinguished, being drowned by the noise of the aeroplane engine. Now we have been able to strengthen the received signal sufficiently to enable messages to be taken."

**FOOL-PROOF FIRE ALARM BOX.**

The accompanying view is that of a fire alarm attachment invented by James P. McLaughlin, which it is proposed to place on the Fire Alarm signal boxes in Philadelphia.

The scheme as shown is a direct acting, keyless door with alarm attachment. The operating lever, shown on the outside of door, has an extension arm on the shaft extending thru the door. When the outside lever is pulled down, the extension arm engages the hook which operates the box mechanism and when pulled to the full downward position, enables the apparatus to deliver four rounds of the station code number.

The shaft on the pulling lever has a rack also attached to it, which, when operated, causes the bell-striking alarm attachment to operate thru a pinion and escapement. The alarm is given by the pulling down of the lever and also on the return of the lever to its original position, propelled by a strong spiral spring attached to the rack.

This scheme is mounted on the original door of the boxes, and while it does not prevent the sending in of malicious false alarms, it, when operated, produces sufficient noise to at least discourage such practise and may attract the attention of

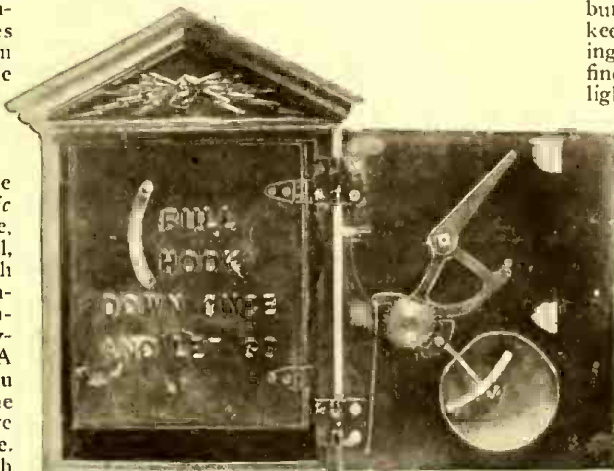

Novel Fire Alarm Attachment That Rings Gong Shown when Box Is Operated. Intended to Discourage Sending in of Malicious False Alarms.

some one standing near it, making possible the apprehension of the maliciously inclined person operating the box.

**SECRETARY DANIELS' REPORT ON NAVAL RADIO SERVICE.**

The name of this service will be changed to naval communication service in the near future, it having taken over the handling of all telegraph, telephone, and cable communications and generally all dispatch work of the Naval Service outside the fleet, in addition to the work of the radio stations, says Secretary of the Navy Daniels in his annual report. The Government and commercial needs have been efficiently served. As an illustration of the growth of the Radio Service in the past few years it may be noted that during the period from December 13, 1912, to December 31, 1913, there were handled a total of 12,854 commercial messages, while during the past fiscal year 97,084 commercial messages were handled. The number of official messages had correspondingly increased, the number for the fiscal year being 628,997.

The Tuckerton and Sayville Stations have been successfully operated under naval control during the year with great profit to the owners.

There are 51 radio stations of the service in operation ashore and on light ves-

sels, 2 of which are high-power stations, 10 of medium power, and the rest of lower power, for communication with ships. In addition, a new medium-power station has been completed and will soon be put in service at Point Isabel, Tex. This station will be of great service to the merchant marine in that section, as well as to the Government in facilitating communication with vessels in Mexican waters. Within the next year it is expected that at least two new high-power stations will be completed, namely, at San Diego and at Pearl Harbor. Work is progressing satisfactorily on the Cavite high-power station, also on medium high-power stations at Puget Sound and at Cordova, Alaska. Estimates have been submitted for another high-power station on the island of Porto Rico, primarily for use in naval operations.

Marked improvement has been made in the radio equipment of ships and of the more important shore stations, enabling wireless communication to be maintained over greater distances and securing an un-failing means of cross-continent communication at all times. Distant control stations have also been established at the principal stations.

**AN ELECTRIC HEATER FOR AUTO ENGINES AND CARBURETORS.**

The purpose of the new engine and carburetor electric heater here shown, is to keep the engine and carburetor warm during cold nights. Every private garage will find it useful. It is attached to any electric light socket and placed under the hood—on the engine and as close to the carburetor and manifold as possible. If the weather is severe, blankets should be placed around the hood to hold in the heat. Generating just enough heat to keep the engine, carburetor and radiator slightly warm, it eliminates starting trouble with its resultant strain on the starting batteries and the wrapping of hot cloths around the manifold and carburetor to cause the gasoline to vaporize properly. Moreover, it saves the wear and tear on the engine caused by cold oil.

The body of the heater contains a rugged heating element which consumes one-tenth of a kilowatt—less than one cent an hour in cost. This element is enclosed in a black metal shell—shaped like and about the size of an ordinary dry cell—which is perforated to allow for the circulation of heated air from



Extremely Useful Device for All Motor Car Owners—an Electric Heater for the Engine and Carburetor.

within. The outfit weighs less than one pound and is equip with ten feet of cord and an attachment plug.



# Experimental Physics

By JOHN J. FURIA, A. B., M. A.  
Instructor in Physics and Science Master, Riverdale Country School

## LESSON TWO.

### Explosions and Explosives (Concluded).

In the last lesson we noted that for any gas whose quantity is always the same, the pressure it exerts multiplied by the volume it occupies is always the same. (Boyle's Law.) Also, whenever in a given volume we have a greater amount of gas than usual, the gas exerts a large

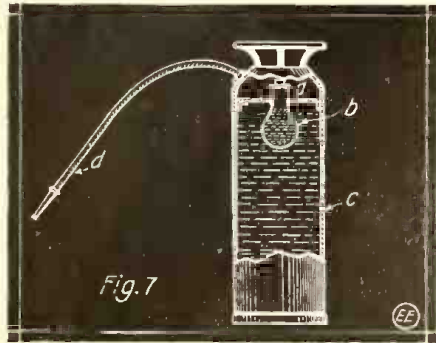

A Typical Example of Gas-energy Apparatus—the Fire Extinguisher, in Which Sulfuric Acid Mixing with Bicarbonate of Soda Solution Generates Gas. This Forces the Solution Out of the Hose "D."

force and the greater the compression the greater the force.

Let us define an explosion making use of the results of Lesson One. We have an explosion whenever we have a gas under such great pressure that it bursts its container. It is the tendency of forces to seek equilibrium that causes the explosion. Hence the first prerequisite to an explosion is a large amount of gas occupying a small volume. This large amount of gas in a small volume exerts a tremendous force and when the force is great enough to burst the container we get an explosion. In some cases we may cause a large amount of gas to occupy a small volume by compressing the gas. This is the physical means of doing so. The chemical means, which we shall discuss later, is generally to transform a solid or liquid into a gas, which process because of the lightness of gases, causes a large volume of gas to appear in the small volume which the solid or liquid occupied.

Experiment 4. Dissolve a little bicarbonate of soda in water. Drop a little concentrated sulfuric acid in this solu-

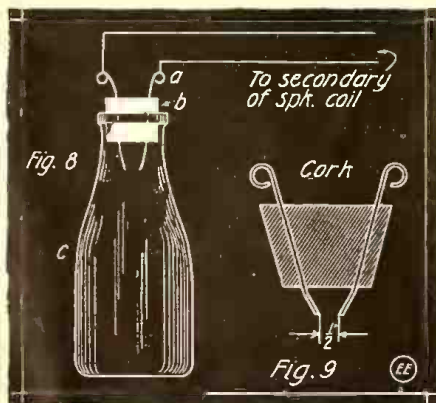

To Demonstrate How a Gas Explodes Violently, Fill a Milk Bottle with an Inflammable Gas. Pass an Electric Spark Between the Cork Wires, When the Cork Will Be Blown Out of the Bottle.

tion carefully by the aid of a fountain pen filler. A gas is formed rapidly. Sup-

pose this experiment were performed in a closed vessel. Obviously the gas formed would exert greater and greater force as more and more gas was formed as this would be concentrating the gas in the given volume. The ordinary fire extinguisher is a piece of apparatus making use of our fundamental principle of explosions. (See figure 7.) (c) is a metal cylinder nearly full of water; (b) is a bottle fastened to the sides of the cylinder and containing sulfuric acid. Bicarbonate of soda is dissolved in the water in (c); (a) is a stopper which fits loosely in the bottle (b). When the extinguisher is inverted, the sulfuric acid gradually mixes with the solution and forms a gas. The tremendous pressure of the gas forces the solution out thru the hose (d) and some of the gas itself comes out also. Both the water and the gas extinguish the fire. Since

out to get into equilibrium with the rest of the air around it, was the explosion. Note that a large amount of gas in a small volume was the beginning of the cause of the explosion.

Experiment 6. Blow up a paper bag. Strike a friend on the back with it and notice the explosion. After blowing up the bag the air in it is not compressed. It has the same pressure as the surrounding air, but on striking something with the bag,

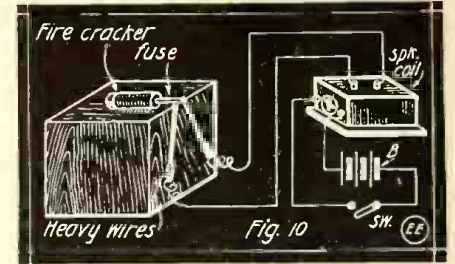

A Safe and Sane Way in Which to Ignite Firecrackers—a Small Spark Coil, Battery and Push Button Does the Trick.

there is a tendency to make the air occupy a smaller volume; its pressure is increased, and the bag bursts with an explosion. (The author learned to perform this experiment in school when the teacher was not looking.)

Experiment 7. In order to understand chemical explosions, the reader should weigh some iron filings, heat them and weigh again. He will find, if he has sufficiently sensitive balances, that the iron gains weight. The explanation is that the iron filings combined with something from the air (a gas named oxygen) and thus increased in weight. In like manner we can heat certain other substances and have them do the reverse of this, i.e., give up some of the gases on heating. That is the principle of explosives. An explosive is a substance which by heating or percussion can be made to give up gas which is combined with it. This gas suddenly formed in a small volume gives an explosion. Gunpowder, dynamite, nitro-glycerin, etc., all contain gases which they give up on exploding.

Experiment 8. Strike several blows with a hammer and then feel the hammer. The hammer feels hot. The force of the hammer hitting creates heat. Hence if we have a substance that will give up gas on slight heating, striking it a blow will set it off and cause the explosion. It is therefore wrong to say that we light a firecracker, since the light does not cause the firecracker to explode. It is the heat that

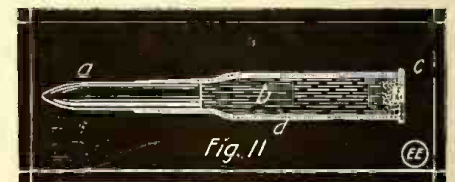

The Modern Rifle Bullet, Is Based on Explosive Action. The Cap Ignites the Powder "b," the Gas of Which Being Confined, Forces the Bullet "a" Out of the Gun Barrel.

does it. Whether we produce the heat by an electric spark, by percussion, or by lighting is of little importance.

Experiment 9. Procure a glass cylinder or bottle made of thick strong glass. Fit a cork stopper to it. (See figure 8.) If a (Continued on page 852)

### IN THE APRIL "E.E."

A new electrical scheme for detecting submarines or sunken wrecks—an idea that may be of inestimable value to Uncle Sam.

The "Strong" High Frequency Apparatus and its application to electrotherapeutics, by Dr. Frederick Finch Strong.

The Aeroplane of To-day—how electricity starts the engine, lights the cabin, provides telephone service and automatically stabilizes the machine while in flight.

Baron Münchhausen's New Scientific Adventures, by Hugo Gernsback.

Electricity in its application to motor-boats.

The R-ray—a new discovery in medical electricity, by H. Rosenthal. Gases and the Atmosphere—Third paper of the new series—"Experimental Physics" by John J. Furia, A.B., M.A., F.K.S.

Construction of a small direct current generator—suitable for lighting lamps and running numerous other apparatus, by George Sturley.

Receiving the Marconi High-Power Stations with the Oscillating Audion, by Samuel Curtis, U.S.N.

The How and Why of Radio Apparatus—Part 4—The Spark Gap.

The Measurement of Inductance. Part 2 of a series on this all-important and timely subject, by H. Winfield Secor and Samuel Cohen.

The Coast-to-Coast Amateur Radio Relay (Washington's Birthday Relay), by W. H. Kirwan, 9XE.

Electro-plating Mirrors by a New Vacuum Process.

the bottle containing the sulfuric acid is fastened upright, the acid cannot mix with the solution unless the apparatus is inverted so as to release the stopper.

Experiment 5. If you own an automobile or a Ford and run it over some glass, nails, etc., you will notice that an explosion occurs as the tire is punctured. If you do not own an automobile inflate a toy balloon and puncture it. An explosion will occur. The gas in the automobile tire was under tremendous pressure and the tire was strong enough to withstand the force, but when the tire was slightly ruptured by the glass, it was no longer able to do so and the explosion occurred. The air inside the tire (or toy balloon) rushing





# The RADIO LEAGUE of AMERICA

HONORARY MEMBERS  
CAPT. W.H.G. BULLARD, U.S.N. NIKOLA TESLA  
PROF. REGINALD FESSENDEN. DR. LEE DE FOREST.



H. Gernsbuch, Manager

W. H. Kirwan, Master of Radio Relays

## The Washington's Birthday Relay, February 24, 1917

By W. H. KIRWAN, (9XE)

Master Radio Relays, Radio League of America

ON the night of February twenty-fourth, every wireless amateur, as well as every member of the Radio League of America, will have the chance of his life to show the world how efficient he is and how much he knows about wireless. Mr. W. H. Kirwan, of wireless fame, has arranged for a double-barreled transcontinental Amateur Wireless Relay, that will set the country a-talking! On this memorable evening, a New York amateur will obtain a certain message from the mayor of the City of New York and this message (the contents of which will be kept secret until 9 P.M., February twenty-fourth) will be relayed over special amateur stations across the country, to be delivered to the mayors of the West Coast cities.

Simultaneously, another message will be handed to a California amateur by the mayor of Los Angeles, and this message will wing itself eastward, from one amateur station to the next, until it is finally delivered to the mayor of New York.

Only special amateur stations listed will do the actual sending. All other amateurs are strictly requested **NOT TO SEND**, but to listen in only: As soon as you receive the M.S.G. (message) rush it to the mayor of your city and get a receipt for it. Valuable prizes will be given for good and speedy work. February twenty-fourth promises to be an exciting evening for all Radio amateurs. We hope you will be on deck and let your motto be: "Watchful Waiting!"

SEVERAL criticisms recently made about the different relays arranged for by the writer, lead one to believe that the Radio Amateurs of this country are prepared for a final test of their skill in relay work. We have been trying in our small way to educate the workers up to the point where successful work could be done; while we admit many stations are relaying now satisfactorily, not until recently have M.S.G.s (messages) been relayed successfully from coast to coast. We have outlined a plan which will really be a true-blue test or race between amateurs and special stations, and while we appreciate the good work the special stations have been doing—my hat goes off to the amateurs who are the real men behind the guns in all relays.

We propose to try and send a M.S.G. from the mayor of New York City and deliver it to the mayors of the West Coast, using special stations going westward. We propose to try and obtain a M.S.G. from the mayor of Los Angeles and deliver it to the mayor of New York, using amateur stations only going eastward from the West Coast.

Every amateur in the country is asked to try his skill at receiving these messages and for heaven's sake please do not *send*—but *listen*, and you will have a bigger job and attain more valuable results and prizes than for a few minutes' sending. You all have a whole year for sending and we ask you to please try and quiet everyone in your state so that you may all try for a prize.

Any station not listed and sending in defiance of our most earnest request will be noted and his "call" published, as well as having his intentional interference brought to the attention of the Radio Inspector in his district. Now boys, we have spent lots of time on these preparations and have been busy working while you were peacefully sleeping, so please take out your fuse plugs on February twenty-fourth at 9 P.M., Eastern time and keep them out. A representative of every wireless organization in this country is working on this relay and we have old men and boys—amateurs and experts—and the Government authorities are watching closely all these tests—so don't get in bad by interfering, before you get a flying start in the game.

### STARTING M. S. G. (MESSAGE).

All of you wish for something hard on the other relays and many complained because they knew the M.S.G. ahead of time—so your wish is fulfilled now, you have the job of your life on your hands.

Our many radio amateur friends will undoubtedly be glad to learn that Mr. W. H. Kirwan has promised to write one article each month for a period of twelve months, for THE ELECTRICAL EXPERIMENTER.

W. H. Kirwan, Master of Relays for the RADIO LEAGUE OF AMERICA and known to the ama-



teur world as 9XE, was born in Baltimore, Md., February 5, 1881. Graduated in Steam and Electrical Engineering in 1897, Brooklyn Polytechnic Institute. Six years in the U.S.N. fitted him for life's more serious work. Six years' study of law prepared him for the bar, but he took up Engineering instead. Was Assisting Erecting Engineer at the Panama Canal for the Emergency Dam machines, and has been in every civilized country on the globe that has a seaport. He has been a student of Wireless Laws since Marconi first flashed his signal across the Atlantic, and he has grown up with the new art. He is the author of the National Relays and the Q. R. M. League of the U.S. He is at present Superintendent of Construction for the Otis Elevator Co., in the States of Iowa and Illinois.

Mr. George C. Cannon of New Rochelle, N.Y., will start the M.S.G. from station 2ZK, on a wave length of 350 meters as soon after N.A.A. routine report on the night of Saturday, February 24, 1917, as becomes possible. Catch his "sigs" if you can. Mr. Cannon has agreed to act as eastern manager of this relay and Mr. Robert T. St. James, 11Z, Great Barrington, Mass., and Mr. C. H. Stewart, 3ZS, St. Davids, Pa., will act as his right and left flanks to relay the M.S.G. one-half hour later south and north, so that all of you on the Eastern coast may get it, but these stations will not send it until one-half hour later than the time Mr. Cannon starts it, and no station other than these is asked to re-send it until next day except 8NH. Write down the M.S.G. you receive—station sending—time to the minute and deliver a copy of it to the mayor of your town and obtain a receipt for it. This is important as you will see later. The other sending stations as listed will be worked in the order of the list and the preceding station will call the next station on the list and give him M.S.G. and Q.S.L. This station will call next station and so on down the line until station 8YO, Columbus, Ohio, receives the M.S.G. He will then call 9ZS, Springfield, Ill., Illinois Watch Co. If 8YO cannot get him QSA—let them send M.S.G. on Q.S.T. and 9ZN, Mathews of Chicago, W.L. 425 meters, will take M.S.G. and give it to 9XN, Grand Forks, N.D., and 9XV, Washington University, St. Louis, Mo. 9XN will give it to 9ZF, Denver, and get Q.S.L. 9XV will wait until 9XN has sent and if no Q.S.L. is received by 9XN 9XV will call 5ZC, Corlett, Dallas, Texas, who will give it to 9ZF, Denver, a station owned by Mr. Doig and aided by Mr. Smith of the Y.M.C.A. Radio Club of Denver. This station, 9ZF, will be flanked by 9XN on the north and 5ZC on the south, who will assist if necessary, if QRN is bad in trying to get M.S.G. thru to 6EA, Seefred Bros., Los Angeles, as has been done several times in some recent tests. 9ZF will have a relay station if necessary 6DM, R. Higgy in Phoenix, Ariz., and also 6SH, our old friend Mac-Quarrie, at Stockton, Cal.

Our old standby, 7YS, St. Martin's College, Lacey, Wash., has promised to be on the job if we start it before his bedtime, so it will be up to 7YS to give it to Vancouver, B.C., and also to Seattle. This reinforcing or flanking of sending stations was necessary owing to the northern route thru Lewiston, Mont., and La Grande, Ore.,

(Continued on page 848)



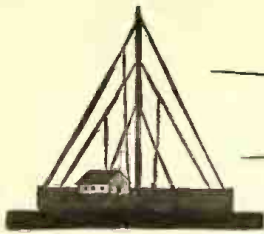

# RADIO DEPARTMENT



## Controlling Toys by Radio

ONE of the most spectacular and interesting electric toy outfits ever conceived was recently built by Mr. Thomas H. Phillips, of Brooklyn, N.Y. This novel and ingenious display consists of a large number of toys mounted on a platform and controlled by wireless waves produced by operating a spark gap excited by a spark coil. The radio controlled toyland is illustrated at Fig. 1. The transmitting apparatus is shown at the left, just in front of the child, who is manipulating the key. The receiving and controlling apparatus, which are the most important features of the equipment, are arranged on the floor underneath the table. Fig. 2 shows the complete device; the receiving and controlling mechanism.

The controlling device is not of the *step by step* type, but of the *selective* type; that is to say, any toy (or other device) can be operated without interfering with the intermediate circuits of other toys. Thus, if it is connected to ten different toys, say in consecutive order such as (1) an electric train, (2) engine, (3) lamps, (4) merry-go-round, (5) spot lamp, and (6) electric fountain, it will not be necessary to connect first the lamps if it is intended to operate the merry-go-round or the spot lamp. In the step by step control system, it is of course necessary for the operator to connect the lamps before he can connect the merry-go-round. Altho the control switch is built along the lines of a step-by-step relay, yet by the addition of a time switch, the inventor makes it a selective device.

This switch is seen in the center foreground of Fig. 2. The two electro-magnets are connected to a polarized relay seen at the lower right-hand corner, which is controlled by a coherer shown in the left-hand corner. An armature is placed across the pole-pieces of the electro-magnets and is fitted with an extending rod. This rod is set free and permitted to move vertically, so as to act upon a ratchet wheel by means of an arm attached to the rod as shown. A switch lever which plays over a number of contact studs is attached to the ratchet lever. The time-control element is placed directly over the end of the movable rod and consists of nothing more than a small brass cylinder fitted with a piston. Just below the piston are two horizontal contact levers, which constitute the main circuit switch. These are normally open when the piston is well within the cylinder, being kept there when the electro-magnets are energized; but as soon as the lever is lowered the piston is released, thus causing the two switch levers to come together and

close the main battery circuit. A definite time interval ensues before the piston falls, thus permitting the operator to turn the rotary switch (by radio waves) to the desired position before closing the main current circuit. The time interval is controlled by means of a check valve placed on top of the cylinder, which may be seen clearly in the photograph. A stop lever for the cogwheel is also provided to prevent the wheel from making more than a single connection at a time.

The complete wiring diagram of the apparatus as used by Mr. Phillips in his Christmas outfit is given at Fig. 3.

For the benefit of those who are inter-

ed on a suitable shaft which is substantially fastened to the board. The cog is caused to rotate by means of a ratchet arm, C, which is held on a vertical rod as the reader will perceive. The lower end of the rod is fitted with an iron armature, D, which is acted upon by two electro-magnets, E, E. A guide-rod is attached to the end of each pole-piece, which passes thru a hole in each end of the armature. This is used for maintaining the rod in a straight position. Both electro-magnets are held together by a suitable yoke and a hole is made in the center for the control rod to pass thru. The stop lever, F, is made from brass and shaped as indicated. It is pivoted on the end of a brass pillar. This is accomplished by a little experimenting. Before going on further with the construction, it is advisable that the instrument so far finished should be tested to see that the cogwheel is properly operated, when the electro-magnets are energized by means of a battery. The control rod should be held in place by means of an additional standard H.

We now come to the most essential part of the instrument and that is the time-control attachment, which makes the complete instrument selective. This is indicated by I and consists of a steel cylinder about 2 inches long by half an inch in diameter. A three-eighths inch hole is bored in this, into which a piston, J, is set, which is about half an inch long. A great deal of care must be exercised to see that the piston fits very snugly in the cylinder and at the same time loose enough to permit it falling very slowly when it is entirely inside the cylinder.

The air between the piston and the upper wall of the cylinder acts as a spring on the piston, so that when it is in, the air gently forces it back. It is advisable to insert an air valve on top of the cylinder

so as to control and adjust the air within the cylinder. This will aid the operator to control the speed of the descent and ascent of the piston. The complete relay is mounted on top of the board in such a position that the control arm is just in the center of the face of the piston, as shown both in the diagram and Fig. 2. The relay control switch consists of a heavy brass plate, K and a flexible phosphor bronze spring, K<sub>1</sub>; these are placed together, but separated by means of a hard rubber washer, L. Both are mounted on an insulating plate, M. When the piston J is up in the cylinder, the contacts should be open, but as soon as the piston falls, due to its own weight and the action of the air within the cylinder, the spring K<sub>1</sub> is caused to interlock with its mate, K, thus completing the electrical cir-

ested in this work, the following details are given so that one may readily duplicate it. Furthermore the radio dabbler can use this type of relay to great advantage in controlling moving vehicles such as boats, submarines, torpedoes, etc., by means of radio waves.

Referring back to Fig. 3, the constructional details of the special relay are shown. The complete instruments are mounted on a base-board 8 x 5 inches. The cogwheel A consists of a flat brass disk containing ten notches which are made by carefully marking the periphery with a marking tool and filing down the teeth. A switch arm, B, is soldered to the wheel, the length of which will depend upon the distance of the contact studs from the center where the cogwheel is stationed. The wheel is mount-



Fig. 1. Inventor's Daughter Operating a Spark Coil, the Waves from which Actuate the Electric Toys Shown.

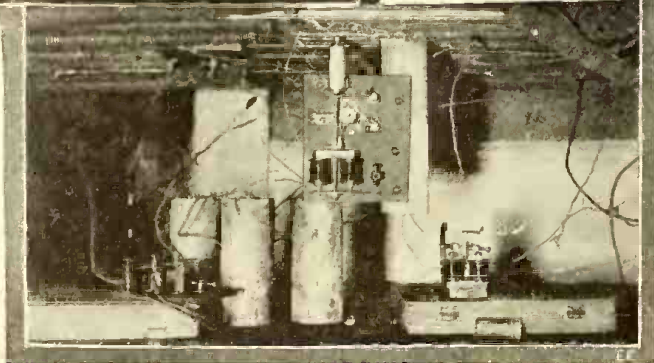

Below:—Fig. 2. The Clever "Selective" Relay Apparatus Enabling One to Control Any One of Several Devices.



cuit as becomes evident from the wiring diagram.

An additional extension, N, is made on the armature, which is equipt with a contact on its end as indicated. This acts upon a stationary contact screw, O. These two contacts are used for completing the circuit of the *coherer tapper*, used for decohering the filings.

This completes the construction of the selective relay and its success of operation will depend upon the manner in which the various parts are made and assembled. The diagram of the complete connections is given in Fig. 3, and it shows a number of devices which have actually been controlled by this instrument, but the constructor may use the idea to control other toys or instruments which he may desire.

The transmitting apparatus may consist of a one-inch spark coil, large ball spark gap, key and batteries. The aerial and ground can be made of a heavy brass wire suspended from the spark gap terminals. A transmitting outfit suitable for this kind of work may be seen at the left of Fig. 1.

The operation of the complete equipment is very simple; it is only necessary to acquaint one's self with the connections. Thus, if the operator desires to operate the solenoid engine (see Fig. 3) he must press the key twice, which will turn the switch lever B to the second stud. Suppose it is desired to run the electric fountain; he then presses the key six times; this will turn the arm B to the proper contact and connects the fountain. A few trials as to the operation of the complete equipment will possibly be necessary at first before one can master it. The operation is very simple and it will certainly repay the amateur for making such an equipment; it will give great fun and amusement, and at the same time prove immensely instructive.

**WIRELESS BEDS.**

An Annapolis midshipman named Dow is credited in local papers with an ingenious and useful discovery. He has found that ordinary bed springs make good wireless receivers. Having connected with wires the springs of his own bed and the beds of his two roommates, and attached an ordinary wireless receiver, Dow is picking up messages without any difficulty, especially those sent to and from Arlington station. It isn't even necessary, he says, to open the windows or to remove the bedding. The beds stand just as usual, serving their original purpose, and the occupants can amuse themselves as they lie abed by gathering in any messages that happen to be flitting about.

This looks like a more useful innovation than that of the Harvard student who attained fame by rigging up an electrical system to pull his window shades down when the morning light bothered him. Bed-springs are considerably cheaper and more

accessible than the poles and wires usually thought necessary for wireless telegraphy. And there's bound to be a sudden boom in amateur wireless when Young America hears that he has a latent wireless plant right in his own bed.

(Midshipman Dow probably is unaware

concrete. The contract for building the dormitory for the eight operators, the yeoman and the cook, and for the noise-proof instrument house, has been let to the Charleston Engineering and Contracting Co., all work to be finished within four months after begun.

The Pittsburgh-Des Moines Steel Co., of Pittsburgh, Pa., will construct the two tubular steel masts and the tower of latticed steel work, including the driving of piles and the anchorage work necessary. One hundred and fifty days are allowed for the completion of this. When all the actual construction has been completed the plant will be turned over to the Navy Department.

The contract for the building calls for the erection of a structure twenty-eight feet by thirty as a dormitory, and a single room nineteen feet by twenty-four to house the instruments. The latter room will be thoroughly insulated from the ground and from the surrounding atmosphere by several layers of non-conducting material built into the walls and doors. The four walls and ceiling will be lined inside with felt, instead of paper or other usual wall coverings, in order to make this insulation all the most perfect. Even the doors will be packed with non-conducting material and will resemble those of ice boxes. There will be no ventilation whatsoever by means of windows, and in order to supply the occupants of the instrument room with fresh air, an electrically driven fan will be used, forcing fresh air into the room from out of doors thru a series of baffles. A vent will be provided to permit the escape of stale air.

**LOS ANGELES Y.M.C.A. WIRELESS GRADUATES.**

Kenneth G. Clark, a resident of Los Angeles and a graduate of the Y.M.C.A. wireless school in that city, has just received his appointment from the Mexican government as "Ingeniero instalador de las estaciones inalamblicas del Distrit," which, in English, means radio engineer in charge of construction. Mr. Clark will have supervision over the erection of a number of wireless stations in Mexico, beginning at Tia Juana within a few days.

Another graduate of the Los Angeles Y.M.C.A. wireless school, H. D. Hayes, organizer of the work and for four years principal, has been reappointed assistant United States radio inspector for the Pacific Coast for another three months, having received his first appointment to the government service last September. He is now stationed at San Francisco.

Courts have recently sustained the patents on Mazda lamps owned by the General Electric Company, and no further importations will be permitted.

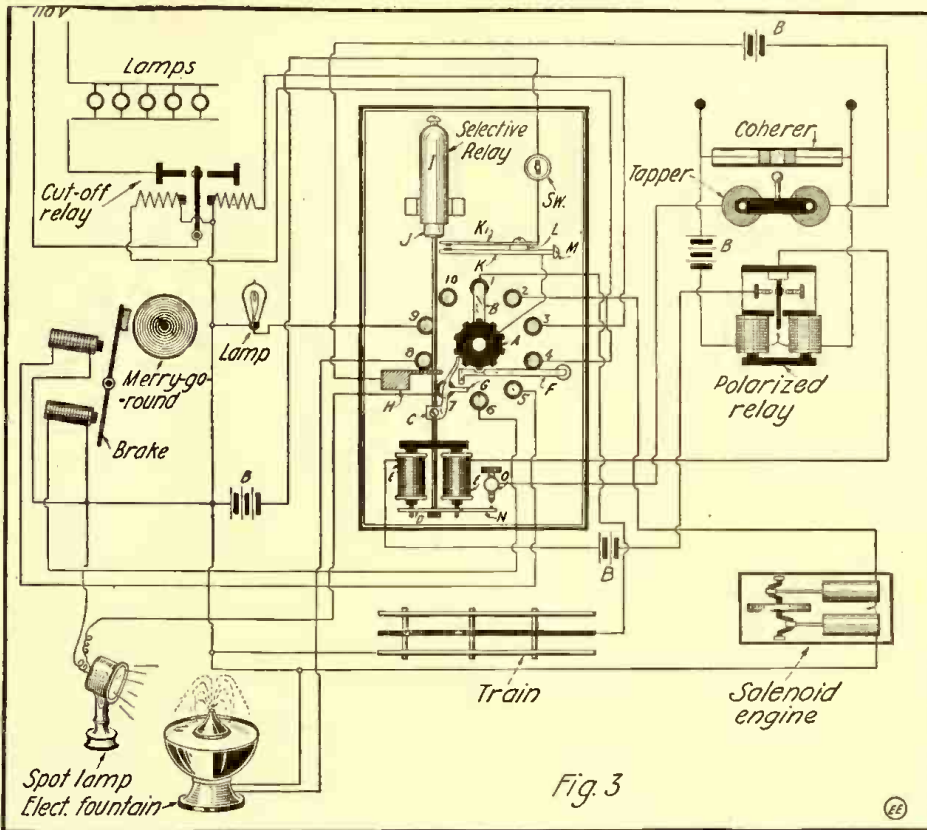

How the Various Apparatus, Such as Table Fountain, Lamps, Electric Engine, etc., Are Connected up to the Novel Radio Control Relay Here Described. The Relay Operates on the Selective Principle.

that the brass bed aerial stunt was fully described some eight years ago in *Modern Electrics!*—Editor.)

**KEEP WIRELESS FREE URGES PROF. KENNELLY.**

Prof. A. E. Kennelly, of Harvard University, told the House Committee on Merchant Marine at a recent hearing that the Alexander bill for government regulation of radio stations is nothing less than an attempt to control the freedom of the air.

"The bill is just such a measure as Gen. Von Bissing might promulgate for Belgium, but is absolutely inconsistent with free institutions," he said.

"Designed as this bill is to protect the Navy from interference and disturbance in its communications, it would have the opposite effect," he declared.

Prof. Kennelly urged absolute freedom in the development of radio-communication thru every agency, rather than to place the whole science of wireless communication under government supervision.

Prof. M. I. Pupin, of Columbia University, also opposed the bill. "The wireless art is a promising and healthful young baby, which the proposed bill would take away from its lawful parents and place in a government institution," he said.

**POWERFUL NAVAL RADIO STATION AT CHARLESTON, S.C.**

Contracts have been awarded for all the construction work on the naval radio receiving station, which is to be erected at Charleston, S.C. It is to cost about \$18,700 and the work to be completed within 150 days. A force from the navy yard is to prepare all foundations, which are to be of



# DeForest vs. The Electrical Experimenter

## A Recent Court Case Wherein the Experimenter Publishing Co. Defeated the DeForest Radio Telephone & Telegraph Co.

By H. GERNSBACK

ON September 20, 1916, in the Federal District Court of New York, before Judge Julius M. Mayer, the Marconi Wireless Telegraph Co. of America won their suit against the DeForest Radio Telephone & Telegraph Co. Judge Mayer ruled that the Audion was an infringement on the Fleming patent and the Marconi Company obtained a perpetual injunction against the DeForest Co. At the present time the DeForest Co. can no longer make and sell the regulation Audions.

Described in a few words, the Fleming patent covers: "A hot filament and a cold plate, both enclosed within an evacuated vessel." The de Forest Audion, as is well known, consists of the above elements, as well as a third additional member, "the grid," interposed between the cold plate and the hot filament. The simple addition of this grid—while admittedly giving better results than a valve without a grid—did not change the basic principle of the Fleming valve, and for that reason the Court ruled that the Audion infringed on the Fleming patent.

On the other hand, the Court understood the function of the grid perfectly with the net result that the Marconi Co. in its turn was enjoined by the DeForest Co. by a perpetual injunction from making or selling a valve containing a grid between the filament and a cold plate.

Now, then, before these injunctions had gone into effect, the DeForest Co., thru its attorney, Mr. Darby, in July, 1916, threatened to bring immediate suit against the Experimenter Publishing Co. if it did not at once desist from publishing certain advertisements, such as the ones displayed in the July issue of THE ELECTRICAL EXPERIMENTER. The advertisements complained of were the following: The Therino Tron Co. of Los Angeles, Calif.; The Pacific Research Laboratories, of San Francisco, Calif.; The Jensen Electric Co., of Chicago, Ill., all of which were advertising three interior member vacuum detectors.

As will be noted, these devices contain "a heated filament, a cold plate and a grid interposed between the two former." The writer understood at once that the DeForest Co. was within its rights by asking the Experimenter Pubg. Co. to stop publishing advertisements of this nature. Accordingly the writer caused to be sent telegrams at once to the three manufacturers in question wherein the advertisers were notified that hereafter no tubes of the character named could be advertised in THE ELECTRICAL EXPERIMENTER.

That the EXPERIMENTER had kept faith with its promise is best demonstrated by the fact that in its September issue (the August issue had gone to press during the controversy) no three interior member vacuum tube advertisements have appeared.

The only vacuum tube advertisements carried since the September, 1916, issue were of the two member kind, which might infringe on the Fleming valve but never on the DeForest Audion.

It came, therefore, as a big surprise when, on December fourth, the DeForest Radio Telephone & Telegraph Co. served a voluminous bill of complaint on the Ex-

perimenter Publishing Co., charging the latter with contributory infringement and asking for extensive damages.

Qualifying as an expert Dr. Lee de Forest in his sworn affidavit accompanying the bill of complaint, made the following surprising statements:

"Again in November, 1916, my attention was called to the December issue of said publication, THE ELECTRICAL EXPERIMENTER, published by the defendant, and I found on page 602 an advertisement of the 'Tigerman Detecto-Amplifier' by the National Electric Manufacturing Company together with a cut showing a structure of detector which appears to be identical with the ones against which injunctions were issued in the suits of the plaintiffs against Myers, and the Audiotron Sales Company, et al., in San Francisco, and Alexander, and the Marconi Company in New York, and identical with the character of advertisements enjoined in the case against the Marconi Publishing Company in New York.

"I also noticed that on page 608 an advertisement appears showing a detector which is an infringement of the plaintiffs' patents, and in this advertisement the structure is called 'The Moorhead Tube' and offered for sale by the Pacific Laboratories Sales Department of San Francisco, Calif.

"I also found on page 594 of this issue an advertisement of the 'Lenzite Crystal Corporation' offering for sale a detector which is an infringement of plaintiff's patents, which is called the 'Lenzite Wireless Detector.'

"I also note on page 607 of this issue an advertisement of the Audiotron Sales Company of San Francisco, Calif., wherein an illustration is shown of the 'Amplitron,' the new 'Vacuum Detector-Amplifier-Oscillator,' which illustration shows a detector device identical with the structure which the said Audiotron Sales Company was enjoined from using, as above stated."

Now, then Dr. de Forest doubtless must have known very well that neither the Moorhead tube, nor the Tigerman tube, nor the Amplitron, *all of which clearly professed as being two interior member vacuum tubes* could possibly infringe on his patents. He knew this well, for he has no patent on a two member tube. Nevertheless he swears to the fact that these tubes infringe on his patents. Still let us give

the learned Doctor swears to it in his affidavit that the Lenzite Detector infringes on his patents. We are strongly tempted to charge the Doctor with bad faith, but on second thought, we prefer thinking that when he swore to that memorable affidavit, he felt in a humorous mood, reasoning no doubt that "A little joker here and then is cherished by the best of men."

Why he just *had* to pick out the Lenzite detector, will probably remain an unsolved mystery for all time. Why he did not carry the joke further by claiming that the "Crystaloi," the Tel-Radion, the Mesco Universal Detector Stand, and the Micropho Detector infringed on his patents we can't see for the life of us. This is surprising, for advertisements of these Detectors were all published in that fateful December, 1916, issue.

Now comes the comic opera part of the suit.

As stated before, the papers in question were served upon the writer on December 4, 1916. On the face of the summons the Experimenter Publishing Company was to answer on December twenty-fourth. But by an amazing oversight, Counsel for DeForest neglected to fill in several important dates in an "order to show cause" attached to the bill of complaint. The net result was that on December eighth the DeForest Company obtained an injunction by default against the Experimenter Publishing Co., enjoining the latter from publishing advertisements such as the ones of the Lenzite people, on their crystal detector, as well as advertisements such as the ones of the Audiotron Sales Co., the National Electric Co., the Pacific Sales Laboratories, etc., all on two member tubes.

A few days afterwards the DeForest people having procured a copy of the January issue in which these very advertisements were published again, caused a new order to be served upon the Experimenter Publishing Company, asking the Court to punish it for contempt of Court for disregarding the injunction and thereby violating the dignity of the Court.

Here was a pretty mess. Remember, the Experimenter Publishing Company had till December twenty-fourth to answer the bill of complaint, nevertheless on December fourteenth an injunction was issued against it! Not till the papers charging the Company with contempt of Court were served did any of the officers of the Experimenter Publishing Company know that Counsel for the DeForest Company had been careless by forgetting to fill in dates on his paper.

Making a long story short, the case came up for final hearing before Judge Mayer of the New York Federal District Court on January 13, 1917.

Counsel for the Experimenter Publishing Company was Mr. J. Edgar Bull. Mr. L. F. H. Betts seconded Mr. Bull. Mr. George A. Hoffman acted as general solicitor.

By that time Dr. de Forest woke up somewhat and before anything else was discussed Mr. Darby formally withdrew the Lenzite Detector from the case.

The contempt motion was then argued at length and the writer, as well as the Experimenter Publishing Company, were charged with bad faith. Mr. Darby sug-



The Tigerman Detecto-Amplifier which Uses Two Filaments and Two Cold Plates in an Evacuated Tube. It Also Uses Two Outside Members as Shown.

Dr. de Forest the benefit of our many doubts.

But now we come to the Lenzite Detector. The advertisement in the December, 1916, issue (on which the complaint is based) shows that this detector is a mineral detector, plain and simple. Its illustration shows it and anyone who can read English can not fail to notice that even the firm's name plainly reads: "Lenzite Crystal Corporation." The most cursory examination must also show to anyone, beyond the shadow of a doubt that this detector can not be a vacuum detector. Nevertheless



gested that in a case where the disregard of an injunction was far less flagrant than in the present one, the defendant had been fined \$15,000 for contempt of Court!!

Judge Mayer, however, not only threw out the motion for contempt of Court, but the original injunction as well. For he held that the injunction order, because it was based on incomplete and faulty original papers served on the Experimenter Publishing Company, made the original order void.

Next came the arguments whether the

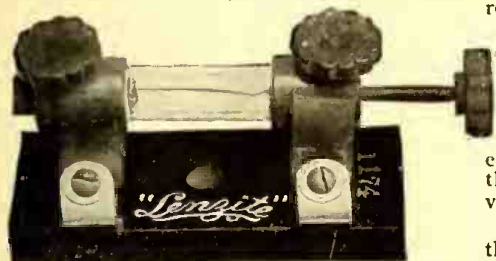

The Lenzite Crystal Detector Which Dr. de Forest Claimed Infringed on His Patents.

Experimenter Publishing Company had accepted advertisements which actually infringed on the de Forest patents.

Carrying out our promise not to accept advertisements of vacuum detectors containing a heated filament and cold plate and a grid interposed between the former, we consented to an injunction to that extent, but the exhibits before the Court were samples of the Moorhead tube and the Tigerman Detecto Amplifier having outside members.

Altho Mr. Darby insisted that the "out-

side member" acted in effect like a grid and therefore infringed on the DeForest patents, the Court ruled that this was not then established.

Our exhibit of the Moorhead Detector before the Court had only two members in a vacuous space. Our exhibit of the Tigerman tube before the Court embodied two of these Moorhead tubes joined end to end.

The Court refused to enjoin the Experimenter Publishing Company from accepting advertisements of these detectors.

This closes the case, which is of far-reaching import not only to the manufacturers concerned but to all wireless amateurs.

The deForest Company, no longer able to sell Audions to amateurs, tried by all possible, as well as impossible, means to stop the various manufacturers from making vacuum detectors, which they claim in no way infringe on the valid de Forest Patents.

Call it jealousy, discontent, or what not, the de Forest Co. went out upon the principle that if it could not make and sell vacuum detectors, no one else should. That by so doing they deliberately hurt the advancement of the art, as well as all amateurs, did not matter one whit. After it was found that the various manufacturers could not be stopt, except by large expense, the simple remedy of intimidating publishers was resorted to. For, it was argued, if the publishers of wireless and technical papers can be sufficiently intimidated, they will no longer take such advertisements with the net result that the manufacturers will be driven out of business.

The scheme worked admirably well with all of the technical, scientific and wireless

papers—with the exception of THE ELECTRICAL EXPERIMENTER, the largest and the most influential of the lot, so admitted by de Forest himself.

THE ELECTRICAL EXPERIMENTER feeling sure of its grounds, accepted advertisements right along of two member vacuum tubes and its judgment proved correct.

Thanks to THE ELECTRICAL EXPERIMENTER—as well as Counsel Bull, Betts and Hoffman—the Wireless Amateur as well as all others concerned, have not been deprived of efficient vacuum detectors—at least not for the present.

MORAL: Tu-be or not tu-be, that's the evacuated question!

Consul Harry G. Seltzer, at Breslau, Germany, reports that one of the Breslau tinfoil factories has succeeded in providing a substitute for tinfoil by producing zincfoil. The new product is similar to tinfoil and is supposed to render the same services.

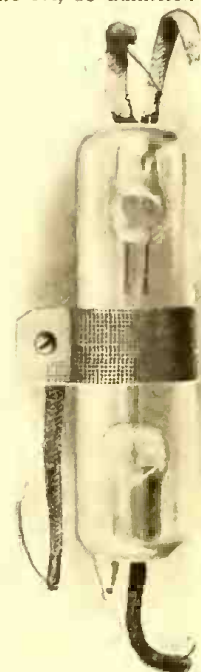

The Moorhead Tube Employing Two Interior Members: a Heated Filament and a Cold Plate.

### SPARK GAPS IN RUNNING LIQUIDS.

Dr. Eccles and Mr. Makower have experimented with radio sparks in running liquids. It was found, after using a variety of transformers and transformer ratios, that for large or small gaps, within the range allowed by the bore of the tube, much lower voltages were required to produce the spark in water than were required for an equal length of spark in air. In constructing apparatus it was ascertained that unless ample thicknesses of material were used, the pressures produced in the interior of the discharger during the passage of the sparks, were sufficient to burst it.

The most satisfactory design consisted of a cube of marble, with a side of about 4 inches, provided with a vertical channel of 1/4 inch bore, thru which the liquids could be caused to flow; entering at the bottom and flowing away at the top, so as to sweep away all the gases formed by the passage of the discharge thru the liquid. The electrodes consisted of two horizontal metal rods, with axes at right angles, forming a spark gap in the middle of the liquid column. In order to prevent the liquid being forced out by the high pressure developed, it was necessary to provide stuffing boxes at the points where the electrodes entered the marble.

The illustration is a horizontal section of the discharger through the plane of the electrodes, and shows the marble cube A, with the liquid column B, in the center and the electrodes C and D, entering at right angles thru the stuffing boxes F and F', and provided with ebonite handles G and H, for adjusting the gap. The length of the gap was adjusted by rotating the handle G, and when the side of the electrode D became pitted, a new surface could be brought into action by rotating the handle H. Experiments made with water showed that if the water flowed too quickly, no

sparking took place, and if the water flowed too slowly, arcing was produced instead of sparking. Even with the flow adjusted so as to give the best possible results, it was found that much energy was wasted, owing to the losses arising from the conductivity of the water. This makes the water-gap less efficient than an air-gap. Using transformer oil instead of water, an efficiency was obtained about the same as that of an air-gap. It was found that when the oil spark was used, with almost any degree of coupling, some impulse excitation was taking place. For example, when the coupling was 12 per cent, a single wave-length of 620 meters was observed in the primary and secondary circuits, and no other wave-length was detected; whereas when the spark occurred in air, the same circumstances gave two distinct wave-

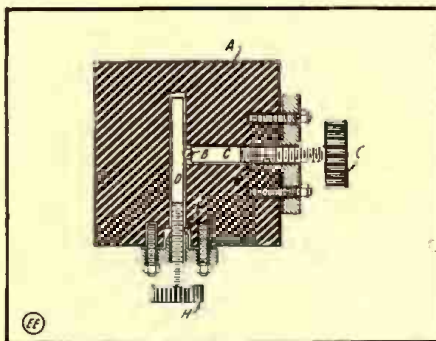

Gratifying Results Have Been Obtained With Sparks Past Thru Oil and Water, the Gap Design Illustrated Comprising a Marble Cube With a Liquid Column Running Thru It.

lengths of 570 and 640 meters. The use of oil presents the advantages of giving better quenching than the air-spark and of eliminating the deafening noise associated with the latter, while the efficiencies of the two forms of apparatus are the same.

### FULLER WAS FULLER.

The following little anecdote, while in order to bring out the point makes it necessary to use the actual names of the parties involved, is too good to let slide by on that account. A certain correspondence school, well known over the United States, recently had an exhibition booth at a certain state fair. One of their means of attracting attention was the installation of a wireless set, a rotary gap furnishing the noise necessary to draw a crowd. One of those connected with the exhibit went by that good old name of Fuller. He was a good sized sort of a fellow and chock full of puns, quips and jests, which were in the habit of coming forth at unexpected moments. Among the visitors at the booth, and a friend of the operator in charge of the set, was another wireless man, also by name Fuller. This Fuller, however, was not by any means of the generous stature of the first Fuller, being by several inches smaller. It happened that the two Fullers met in the booth at the same time, and the operator hastened to introduce them.

"Mr. Fuller, meet Mr. Fuller." As the two shook hands, Fuller the larger boomed: "Mr. Fuller, you're fuller than I am!" Fuller the littler looked highly indignant, as he is known to be of strictly temperate proclivities, and queried "How so?" Came back Fuller the larger, "Well, you're a little Fuller!"

Now Fuller the littler is laying for Fuller the larger and it is expected that there will be a dual of wits when they again meet.

P. OARD.

### THIS IS AWFUL

Said the wireless man to a friend of his, a bookkeeper for the company in which he worked: "Never go to sea during the stormy season. It would queer you with your company." "How so?" quoth the bookkeeper. "Why, you're apt to lose your balance," said the wireless man, as he ducked for the open doorway.

P. OARD.



**TRI-CITY RADIO LABORATORY.**

Herewith is presented a photograph of the experimental radio station—9XR. This station, that of the Tri-City Radio Laboratory, Rock Island, Ill., has covered exceptional distances, both receiving and sending. The sending range on the Presidential Relay of October the 27th, was 1,085 miles. Our message was clearly copied at this distance, says R. Karlowa, operator.

Station 9XR is equipt with the *Hall Recording Relay*, which permits the message to be copied on tape or read from a standard sounder. This is the only station in this country equipt with such a device to our knowledge. (The Hall radio relay was described in the "Latest Patents" columns of the February, 1917, issue of THE ELECTRICAL EXPERIMENTER.—Ed.)

All of the arc stations, as well as the spark sets, are daily being recorded by this device. Under satisfactory conditions the operators are able to record the German stations.

Besides two complete sets, one of which is shown in the photograph, 9XR is equipt with a wireless telephone set (Oscillation type) and a standard Federal receiving cabinet.

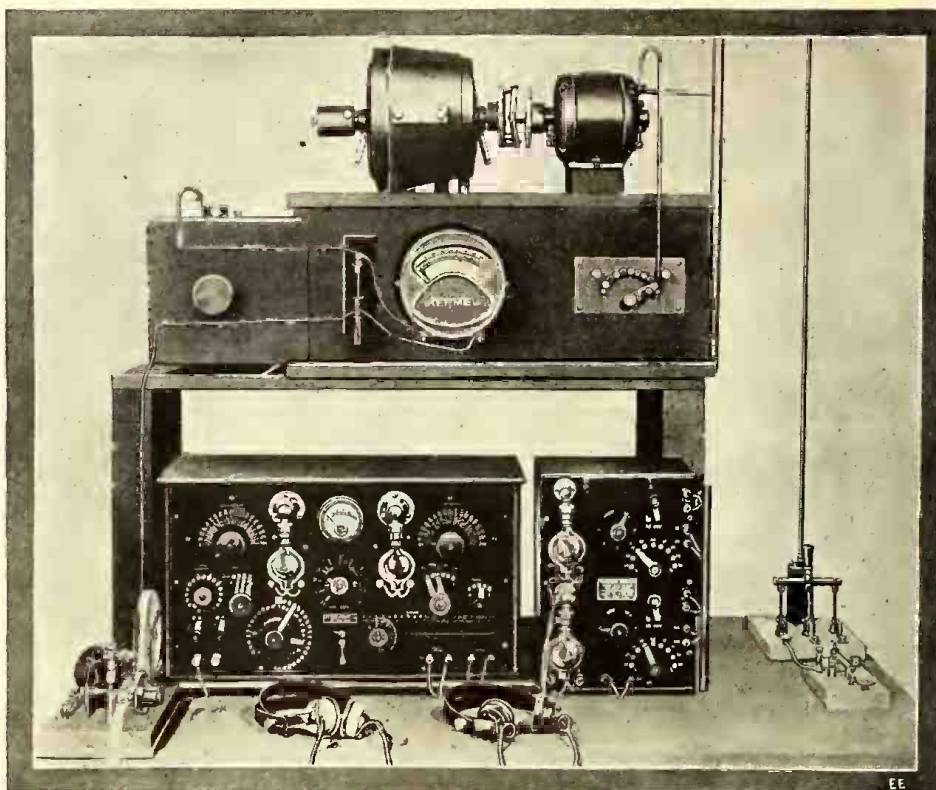

The Excellent Radio Set at the Tri-City Radio Laboratory, Rock Island, Ill. It is Equipt With the New "Hall Recording Relay," Which Enables the Operator to Secure an Accurate Copy of Every Message on a Paper Tape.

for equal audibilities, the condensation needed at pitch 128 is double that needed at pitch 256. In like manner the condensation needed at 256 was 1.6 of that at 512 per second. Finally, the condensation necessary for audibility at 85 per second was almost precisely double that for pitch 128: Confirmation was also obtained by direct comparison between the cans, of frequencies 85 and 256. Thus, to summarize:

times stated as 40,000 per second in children) falls steadily with advancing years.

Considering the results in their bearing on radiotelegraphy, it appears that we can, by increasing the spark frequency at the sending station, increase the effective sensitiveness of the receiving station many hundred times. This can be done, too, without entailing the difficulties connected with an increase in the sensitiveness of the wireless receiver itself. An additional advantage in using a high-pitched musical spark is that the ear picks out such signals with ease in the midst of ordinary interferences and strays. In spite of these considerations, however, the practise of some of the wireless telegraph companies and of certain navies is to use notes not higher than 400 or 500 per second frequency. Prolonged trials of high-pitched notes have shown that they tire the ear rather quickly.

**MINNEAPOLIS RADIO TALKS WITH SAYVILLE.**

Wireless stations at Sayville, L.I., Darien, Panama, and other distant points on this continent communicated with the All-Crafts Club recently. The event was the annual meeting of the club at the Minneapolis Athletic Club, at which a wireless receiving outfit had been set up.

The club meets every Tuesday noon at the Elks' Club for luncheon, except once during the month, when it meets at the Athletic Club for dinner and a lecture and demonstration of some scientific or mechanical phenomenon. Wireless telegraphy was the subject on this occasion. Mark Frazer and James A. Coles were the demonstrators. Their outfit was capable of picking up European radios had the atmosphere been propitious.

The club meets every Tuesday noon at the Elks' Club for luncheon, except once during the month, when it meets at the Athletic Club for dinner and a lecture and demonstration of some scientific or mechanical phenomenon. Wireless telegraphy was the subject on this occasion. Mark Frazer and James A. Coles were the demonstrators. Their outfit was capable of picking up European radios had the atmosphere been propitious.

**AMERICANS USE WIRELESS FREELY?**

Garrulous American sea captains, talking with each other by wireless, have brought down on their heads the wrath of Australian government officials, it was learned recently.

Complaint has reached Washington that American ships 2,000 miles apart in the south seas discuss trivial subjects, when the Australian wireless is trying to get into the air important messages.

The American captains declare that antiquated wireless equipment in use in Australia is to blame for the situation. They deny that trivial messages have been exchanged.

The Australian charges are being investigated by American government officials and a curb will be put on the practise if it is found that the wireless is being used for a too free exchange of unimportant messages.

**SENSITIVENESS OF THE EAR.**

Rayleigh found the sensitiveness of the ear to sounds of different pitches to be as follows:

N.....	c' (256)	g' (384)	c'' (512)
s.....	.60x10 <sup>-9</sup>	4.6x10 <sup>-9</sup>	4.6x10 <sup>-9</sup>

where s is the condensation (or rarefaction) in the air required to cause an audible impression, states Dr. Eccles in his *Handbook of Wireless Telegraphy and Telephony*. Here the condensation is the maximum which occurs during the course of a vibration. The method employed depended upon a knowledge of the rate at which energy was emitted from a resonator under excitation by a freely vibrating tuning-fork. In a careful re-examination of this question, Professor Max Wien, working with the telephone, finds not only a still higher degree of sensitiveness, but also a much more rapid variation with pitch, as shown by the following figures:

N	s	N	s
50 ..	1.14x10 <sup>-7</sup>	1,600.....	0.99x10 <sup>-11</sup>
100 ..	0.78x10 <sup>-8</sup>	3,200.....	0.90x10 <sup>-11</sup>
200 ..	0.71x10 <sup>-9</sup>	6,400.....	1.63x10 <sup>-11</sup>
400 ..	0.85x10 <sup>-10</sup>	12,800.....	5.7 x10 <sup>-11</sup>
800 ..	1.63x10 <sup>-11</sup>		

In this table, N, indicates frequencies and s, condensations in c.g.s. (centimeter-gram-second) units. To test the question further, Rayleigh experimented in a new way, using metal cans maintained by electro-magnets as vibrators. The experiments showed that

N.....	512	256	128	85 per second
Relative value of s.....	1	1.6	3.2	6.4

Thus the differences of sensitiveness are less than those found by Wien. The sensitiveness of the ear varies greatly with age, and the upper limit of audition (some-

**AEROPLANES TO CARRY SPECIAL WIRELESS DYNAMO.**

The accompanying illustration is that of a new wireless telephone generator for use especially on aircraft.

It is a special generator or dynamo for wireless telephone transmission and reception for use in aeroplanes only. It is a combination of two direct current generators mounted in a torpedo-shaped shell, one of the generators delivering low voltage for lighting the filament of the receiving Audion, while the other delivers



Special Wireless Telephone Dynamo Recently Developed for Use on Aircraft. It Combines Two Dynamos, One Giving 6 Volts and the Other 1500 Volts, For An Oscillation.

1200 to 1500 volts, direct current, for transmission. Both armatures are mounted on one shaft and supported at both ends by ball bearings. The outfit is intended to be driven by a small auxiliary air propeller. The outfit has been tested and approved by the U. S. Navy.



## New Undamped Wave Tuner Has Adjustable Disc Core

HEREWITH is given a description of a new Undamped Wave Receiver designed by Ernest C. Mignon, the well-known radio engineer.

The object was to eliminate all unnecessary apparatus such as loading-coils and

as to permit all required position adjustments by sliding and rotating the shaft supporting it.

The object of the *metal Distorter* is to control the fields of distortion and to facilitate a decrease or increase in wave length without the cutting in or out of coils or condensers, making it possible to intensify signals to more than 65 per cent of their ordinary strength.

The *Auto-Transformer* encircling the detector bulb has been fully described in a previous issue of THE ELECTRICAL EXPERIMENTER.

One remarkable fact is that only one size of wire is employed in this new system, primary and secondary being the same, and the smaller or finer the more efficient the apparatus, which fact has been positively ascertained by extensive experiments in the laboratory.

Another important feature is that the well-known detrimental effects in other systems due to the close proximity of the different circuit inductances, are entirely eliminated and the capacity of the operator's body has absolutely no effect on the incoming signals, it is claimed.

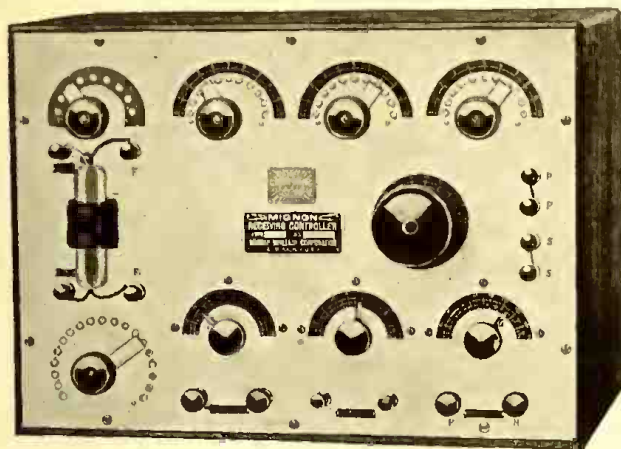

Appearance of Recently Perfected Undamped Wave Tuner, Which Operates on a New Principle—That Involving a Variation in the Magnetic Coupling, by the Use of a Movable Disc Core.

loose-couplers and above all the *distortion of the magnetic fields* in the tuner by the proximity of the operator's hand or body.

The first step was to build an inductive tuner, consisting of three distinct windings or coils, namely a primary and two inter-circuited secondaries, all three identically the same, ring-shaped and supported in grooves cut into insulate discs, containing the same amount of wire and sections.

These three ring-coils are then solidly mounted on the same plane in clover shape, instead of facing each other, as in all other systems, which is accurately illustrated in the accompanying illustrations.

The magnetic fields of all three coils are interlinked with each other thru the center of each of them and may be pictured as rings or as called hereafter by the inventor, *fields of distortion*, and which for the first time since the history of wireless signaling has been made use of to advantage and proved to be of the greatest importance for future development in radio telegraphy and telephony.

The fields of distortion are identically of the same dimensions as that of the actual coils and facilitate an increase of approximately 100 per cent in the wave length capacity; in other words, it requires only one-half as much wire to build a tuner for a certain wave length of this type, as it would for any other.

One of the features in this invention is

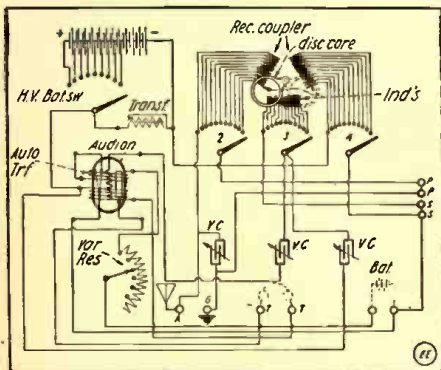

Circuit Connections for Vacuum Detector and Adjustable Disc Core, Undamped Wave Receiver.

the *Metal Disc or Ring Core*, called by its inventor a *Distorter*, which is so installed

helpful to all fellow radio workers.

One of these amateurs is IZD, who is recognized as the only amateur working any great distance who lives in eastern Massachusetts.

Another is IASD, who has heard a number of amateurs in Illinois, Michigan, Indiana, and Ohio; and who has worked 100 miles with a 1/4 K.W. transmitter.

Contributed by "BIX."

### A SIMPLIFIED CODE.

On page 175 of the July issue of the

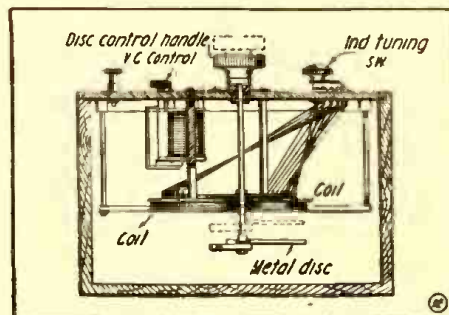

Side Sectional View of New Undamped Wave Tuner Having Adjustable Disc Core.

"E.E." an article appeared describing a code composed entirely of *dots*. Such a code is useful to those who wish to tap signals thru a wall, along a pipe, etc., without the use of instruments. When the number of dots constituting a letter is greater than five this code is, however, difficult to send and still more difficult to receive. For those who are already familiar with the Continental or Morse code, a much simpler system is available. This system also saves learning a new code. The only change necessary is to substitute two dots for each dash, i.e.:

- A ...
- B .....
- C .....

This is much easier to read and will be found equally efficient. The idea will prove of advantage to organizations such as the Boy Scouts.

Contributed by F. C. HAMILTON.

### A NEW FLAT SWITCH POINT FOR TUNERS.

The new flat switch point here illustrated is a marked improvement in switch points. They are made from flat stock, of brass 1/16" thick and 1/2 inch long under the head, which makes it possible to get a great many more points in a given space. These points when mounted present a very neat appearance. They are made slightly tapered, which holds them securely in place. It is but necessary to drill the holes in the manner shown in the illustration, that is to stagger them. The switch points are driven in and the connections are soldered

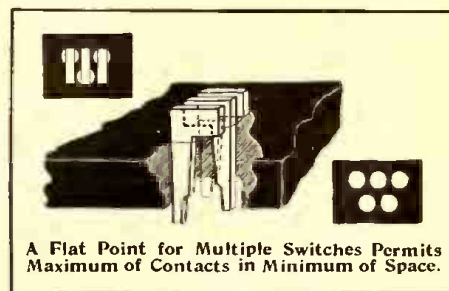

A Flat Point for Multiple Switches Permits Maximum of Contacts in Minimum of Space.

on the reverse side. These switch points, owing to their extremely small bulk, cut down the distributed capacity in an instrument more than half, their inventor claims. This is an extremely valuable feature for serious long distance work.

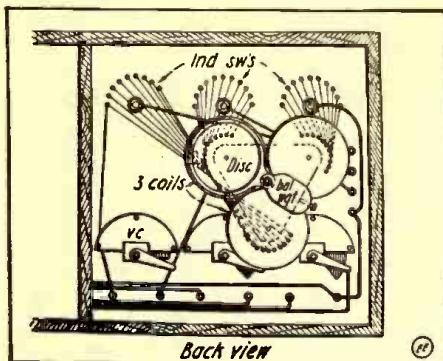

Rear View of New Undamped Wave Tuner, Showing Position of Three Coils and Movable Disc Core.

On an aerial sixty feet long and thirty feet high, signals from stations 9,000 miles away have been recorded, which were by no means weak.

### AN EFFICIENCY SUGGESTION FOR "RADIO-BUGS."

Lately several young men who are studying radio engineering at a nearby university have moved their entire amateur receiving and sending apparatus to the cellar, near the water meter. Their idea is to get the shortest possible ground lead. One youth, whose cellar is too damp to operate in, has his sending set in the cellar but has his receiving set, key, etc., almost directly above on the first floor. The results of these changes were surprising as well as gratifying. One amateur previously having his set in the attic, increased his radiation from 1.7 amps., to 2.2 amps., without touching the closed circuit and by simply putting the open circuit in resonance once more, after the change. These amateurs are considered among the best in this part of the country (Massachusetts) and this little "tip" past to me by one of them, should be



# The Calculation and Measurement of Inductance

By H. WINFIELD SECOR and SAMUEL COHEN

## PART I.

This discussion on the calculation and measurement of inductance is intended for the radio experimental and other readers who desire to compute the proper size of tuning coil or loose coupler to use for a certain range of wave lengths. Part 2 of this series will explain in simple language

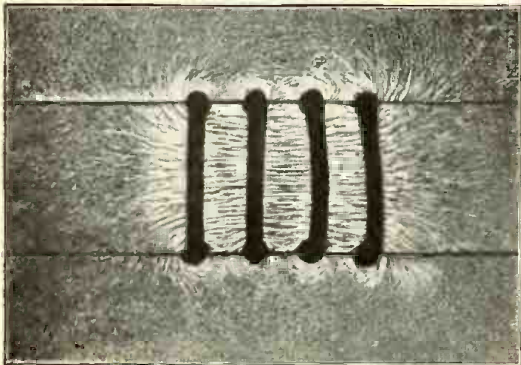

Fig. 1. Appearance of Magnetic Field About a Coil of Wire Carrying Current. "Inductance" Is Express as the Opposing Effect of the Self-induced Current, Created by the Magnetic Field Reacting Upon the Coil.

how Inductance is measured, while Part 3, the final paper, will conclude with a practical design of loose coupler, adaptable to various wave length ranges. The day of the 12,000 meter loose coupler is here, and here to stay.

**A**LTHO a considerable amount of data has been published on the subject of Inductance, very little has been said regarding its calculation and measurement in a simple enough manner to enable the experimenter to determine the inductance values of coils which he has about his station and laboratory. It is therefore the purpose of this article to show as clearly as possible the method of finding the inductance of a given coil, both of the single and multi-layer types.

Firstly, it is well known that whenever an electric current passes thru a conductor a magnetic field is produced about that conductor. Fig. 1, and the intensity of the field depends upon the current flowing thru the wire. Those magnetic lines of force about the wire produce an e.m.f., passing in the opposite direction to that of the impressed e.m.f.

The effect of this is to counteract the impressed current, thus decreasing its value. This counter e.m.f., acting upon the whole electrical system is called "self inductance" and every conductor irrespective of its shape, length or size, has some self-inductance. However, the amount of inductance of the conductor depends upon several factors, namely: shape, length, diameter of conductor and the amount of current flowing thru the wire. This last term is usually eliminated in actual inductance calculations, especially in coils which are connected in high frequency oscillating circuits.

Since the magnetic effect of a conductor carrying an electric current is increased when the wire is formed into a circle and since the self-inductance depends upon the number of magnetic lines of force produced, it is self-evident that a circular conductor of the same length and same size has a larger self-inductance value than a straight wire. It is readily seen therefore why circular coils are employed instead of long, single conductors. With compact coils the magnetic field is more concentrated.

The Henry is the unit of inductance. A circuit is said to have an inductance of one henry, when the current is changing at the rate of one ampere per second and inducing a pressure of one volt in the circuit. One henry is equal to  $10^9$  or 1,000,000,000 (centimeters) C.G.S. electromagnetic units (C.G.S.) is the centimeter-gram-second system; 1 milli-henry = .001 henry or  $10^6$  centimeters. Henries times  $10^9$  = inductance in cms., and inductance in cms., divided by  $10^9$  gives the result in henries. A coil is said to have 1 C.G.S. unit of inductance when 1 C.G.S. unit of current flows thru 1 turn, producing 1 line of force. Let the current in amperes be  $I$ , number of turns in coil  $T$ , and  $I_t$  number of lines of force due to coil, then we have for the henries of inductance of the coil the expression:—

$$L = \frac{I_t \times T}{10^9 \times I}$$

The self-inductance of a single, straight round wire can be determined by the formula:—

$$L = 2l \left[ 2.3026 \log_{10} \frac{4l}{d} - 1 \right] \quad (1)$$

where  $L$  = inductance in centimeters.  
 $l$  = length of wire in centimeters.

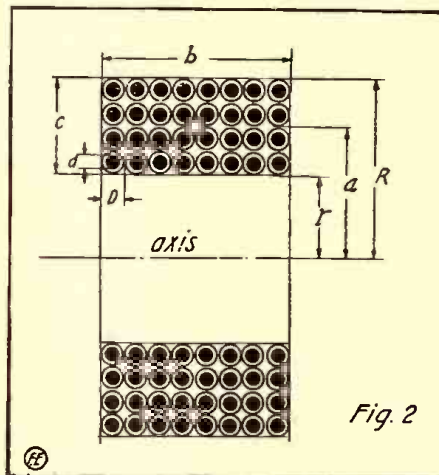

Showing Geometrical Dimensions of Coil as Used in Calculating Its Inductance by the Brooks-Turner Formula.

$d$  = diameter of wire in centimeters.  
Suppose it is required to find the induct-

ance of a single antenna wire whose length is 400 feet and diameter .08 inch. Converting the above units into centimeters and substituting in formula No. 1, we get:—

$$L = 2 \times (400 \times 30.48) \left[ 2.3026 \log_{10} \frac{4(400 \times 30.48)}{.08 \times 2.54} - 1 \right] \\ = 24384 [2.3026 \times 5.38021 - 1] \\ = 27,766 \text{ cm. or } .00027766 \text{ henry.}$$

It is therefore possible with the above formula to determine the self-inductance of a single antenna wire. The result obtained with this formula is approximate as it does not take into consideration several factors such as curved or bent portions of the lead-in, etc. The surrounding objects about the wire have an appreciable effect upon the inductance also. However, for approximate results the above equation will be found useful.

The common formula given in text-books for computing the inductance of coils having a length at least 20 or more times the diameter is given here:

$$L = \frac{10,028 \times R^2 \times T^2}{10^{11} \times l} \quad (2)$$

Where  $L$  is in henries;  $R$  the mean radius of coil in inches;  $T$  the total turns in coil;  $l$  the axial length of coil in inches. Result in cms. = henries  $\times 10^9$ . For coils containing iron cores the inductance must be multiplied by the permeability, found in all magnetization tables.

The most common form of inductance that the amateur is familiar with is that of a straight cylinder with a certain number of turns on it. The inductance of such a coil can be found by substituting its various dimensions in the following expression:—

$$L = \frac{(5 \times d \times N)^2}{S + \frac{d}{3}} \quad (3)$$

Where:  $L$  = inductance in centimeters  
 $d$  = diameter of coil in inches  
 $N$  = total number of turns  
 $S$  = length of coil in inches.

Example:—Suppose it is necessary to find the inductance of a coil whose dimensions are as follows: 12 inches long, 3 inches in diameter with 250 turns of No. 18 wire.

Substituting the given values in the above equation we get

$$L = \frac{(5 \times 5 \times 250)^2}{12 + \frac{3}{3}} = 3,004,807 \text{ cms.}$$

The above coil has an inductance of 3,004,807 cms. and if the result is desired in microhenrys it is only necessary to divide

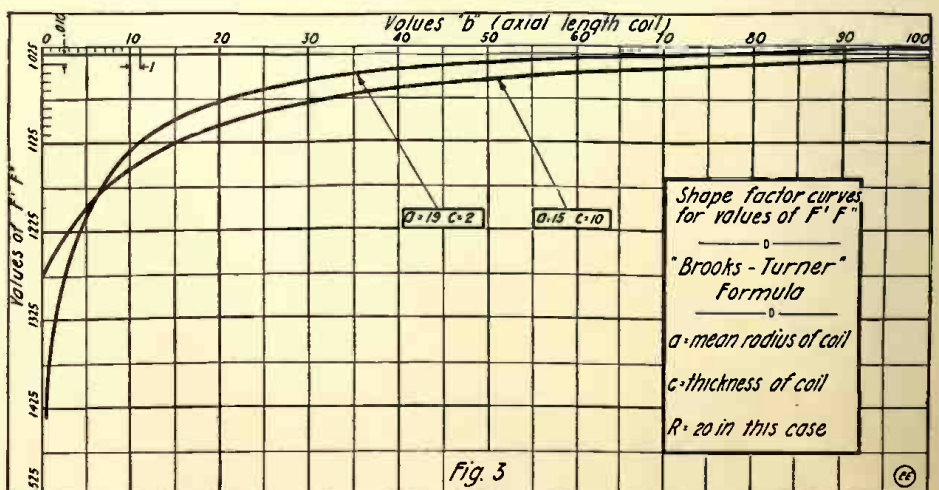

Direct-reading Curves Giving Various Values of Product  $F'F''$ , as Used in the Brooks-Turner Inductance Formula, and for Varying Dimensions of Coils.



the answer by 1,000, thus giving 3,004 microhenrys.

The above formula will hold true when the coil is very long (length 20 times diameter, etc.) and when the answer is not required to be very accurate. The formula given below will prove more accurate for a coil whose diameter is greater than its length. This equation is by Dr. A. Russell:

$$L = (\pi DN)^2 \left[ 1 - \frac{4D}{3\pi L} + \frac{1}{8} \left( \frac{D}{L} \right)^2 - \frac{1}{64} \left( \frac{D}{L} \right)^4 \right] \quad (4)$$

Where: L = inductance in centimeters  
 D = diameter of coil in cm.  
 N = number of turns per cm.  
 l = the length of coil in cm.

Altho the above formula is quite accurate for calculating the inductance of a coil of any length, there are still two other formulae which are very accurate for any size coil, even those having a length of one-tenth the diameter or a single turn.

The first of these is due to Nagaoka, who has developed a very simple equation as follows:

$$L = 4\pi^2 a^2 n^2 bk; \quad (5)$$

Where:—L = inductance of coil in centimeters.  
 a = radius of coil to center of wire, in centimeters (mean radius)  
 n = number of turns of wire per cm. length of coil.  
 b = length of coil in centimeters.  
 K = a constant.

The only difficulty encountered in the use of this well-known formula is that involved in the constant, K, the value of which must be obtained from a table. The table gives correction factors for different lengths and diameters of solenoids. It does not take into consideration the so-called *current sheet effect*, which is the effect due to the leak between successive turns of wire. (See end of this article.)

For accurate calculations the formula is one of the best that one can employ. These tables are quite large and space does not permit us to publish them here. However, those readers interested in this formula and tables can refer to pages 224 and 225 of the *Bulletin of the Bureau of Standards, Vol. 8, No. 1, by Rosa and Grover, 1912.*

A new universal formula for determining the inductance of any coil, absolutely irrespective of its size and shape, has been deduced by Professor Morgan Brooks. The equation which he has developed is applicable to all sizes of solenoids. This formula has been carefully checked for coils whose inductance was measured and also calculated by other standard precision formulae such as that of Stefan and Kirchhoff for coils of but a single turn. It was found that the results obtained differed infinitesimally from those obtained with Nagaoka's formula.

Two forms of the Brooks universal formula are herewith given. One in which the dimensions are in centimeters and another in which the English units are used. Both give results in henries.

$$L = \frac{Cm^2}{b+c+R} \times \frac{F' F''}{10^9} \quad (\text{centimeter units}) \quad (6)$$

$$L = \frac{0.366 \left( \frac{Fl}{1000} \right)^2}{b+c+R} \times F' F'' \quad (\text{English units}) \quad (7)$$

Where:—L = inductance in henries

- a = mean radius of winding
- b = the axial length of the coil
- c = the thickness of winding; for single turns use (d) dia. of wire in inches
- R = the outer radius of the winding
- Cm = indicates the length of the conductor in centimeters
- Fl = the length of the conductor in feet and Fl/1000 = thousands of feet

containing any number of layers are covered by it also.

The direct reading inductance curves at Fig. 4 have been calculated by the authors from the Brooks equation (No. 6) and will undoubtedly prove useful to the radio and electrical experimenter as these values have not been given before to our best knowledge. The two windings have been chosen so that one may select suitable length coils for use in building small and medium size loose couplers, tuning coils and variometers.

For the inductance values of larger size coils suitable for extra long wave reception

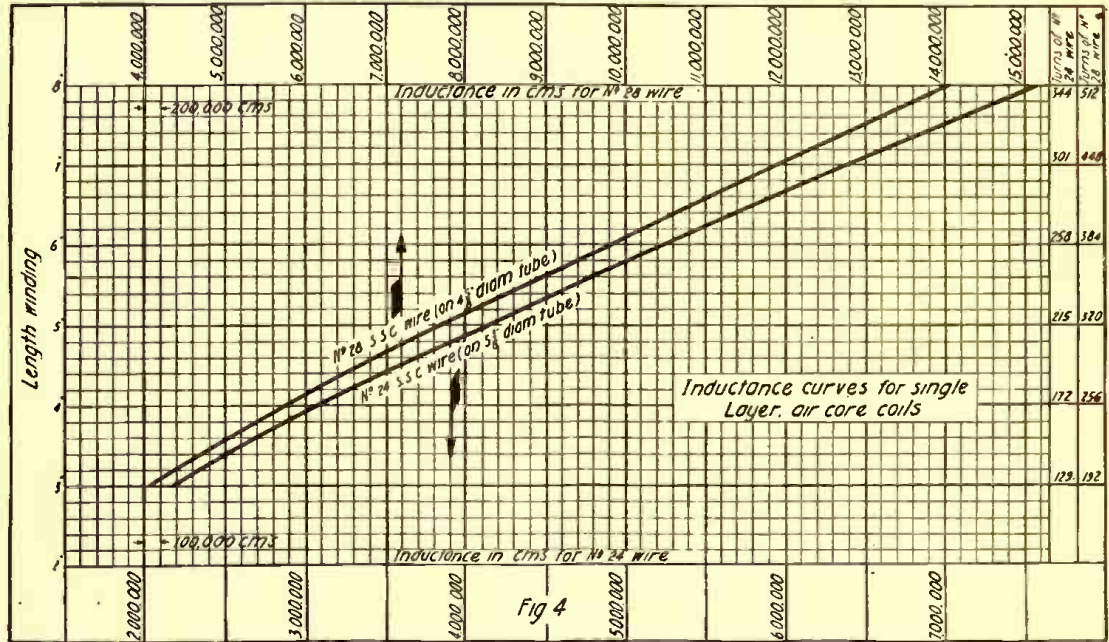

Direct-reading Curves for the Inductance in Centimeters of Typical Loose-coupler Primary and Secondary Windings.

N = total number of turns in the winding, whence

$$Cm = 2\pi aN \text{ when (a) is in centimeters and}$$

$$\frac{Fl}{1000} = \frac{2\pi aN}{12,000}$$

when (a) is in inches.

In (7) the conductor length is in thousands of feet and the coil dimensions in inches while 0.366 is the conversion factor. F' and F'' are empirical coil-shape factors, dependent upon the relative and independent of the absolute dimensions of the winding. The values for these two factors are obtained by the following expressions:

$$F' = \frac{10b+12c+2R}{19b+10c+1.4R} \quad (8)$$

$$F'' = .05 \log_{10} \left( 100 + \frac{14R}{2b+3c} \right) \quad (9)$$

The notation of the different functions used in the first two expressions can be more readily understood by referring to Fig. 2, which is a cross section of a solenoid. The curves of Fig. 3 enable one to select directly the value of the product F' F'', for a wide variety of windings, from those having a length about three times the mean diameter to those whose length is but 1/300th the diameter. These shape factors given by Fig. 3 are relative functions only, as becomes apparent and are not in inches or cms., but serve for computations in either system. The Brooks formula is accurate to a small fraction of 1 per cent in most all instances, even for coils of a single turn. In the case of a tested (single turn) coil the calculated value of inductance by this formula was only -0.88 per cent in error, which of course represents the extreme test for any formula of this nature. Solenoids

and the method of figuring the desired amount of tuner inductance, with respect to the electrical constants of the antenna, the reader is referred to the article by Mr. C. Ballantine, entitled "The Design of Large Radio Receiving Transformers" in the February issue of THE ELECTRICAL EXPERIMENTER.

In using the Brooks universal formula, the factors, F' F'', may be disregarded for long coils and for approximate results the formula reduces to:—(L in henries).

$$L = \frac{Cm^2}{(b+c+R)10^9}; \quad (10)$$

$$QrL \text{ in cms.} = \frac{Cm^2}{(b+c+R)}; \quad (11)$$

The equation can still be reduced for very long coils, since "b" becomes so large as compared with "c" and "R" so that equation (10) becomes:—(L in henries).

$$L = \frac{Cm^2}{b \times 10^9}; \quad (12)$$

$$QrL \text{ in cms.} = \frac{Cm^2}{b} \quad (13)$$

The above expression will be accurate within the limits of approximation with coils whose length is ten times the diameter. It may be used to advantage in calculating the inductance of spiralled antennae.

In order to become more familiar with the use of Brooks' formula, we will illustrate it with a typical problem. Let us determine the inductance of a variometer coil whose length is one inch, diameter 6 inches and wound with a single layer of No. 20 double cotton covered wire.

$$\left( \frac{Fl}{1000} \right)^2 = \left( \frac{2\pi aN}{12,000} \right)^2 = \left( \frac{2 \times 3.1416 \times 3.016 \times 25}{12,000} \right)^2 = .001521$$

$$L = \frac{0.366 (.001521)}{4.064} \times F' F''$$

(Continued on page 850)



# Is Radio Transmission Due to Magnetism?

By J. S. CLEMENS

The writer has looked up different explanations in several text-books as to the exact theory on which wireless telegraphy is based, but none of them seem to explain the matter very thoroly, and I would therefore like to submit my opinion, which is as follows:

We all know that a compass needle points

graph and telephone signals will also follow the curvature of the earth.

Possibly some of the readers of THE ELECTRICAL EXPERIMENTER will give their opinion as to the exact theory on which wireless telegraphy, also wireless telephony. [Address all communications to the Editor.]

[Editorial Note:—The theory involved in the above discussion by Mr. Clemens is very interesting and possibly brings out some rather startling natural electrical and magnetic phenomena but little known to the average person or even to the electrical experimenter in many instances.

The accepted wireless theories of to-day which, of course, are little more than theories, are based on the supposition that the electromagnetic waves set up by a wireless transmitting station are propagated thru what is known to scientists as the ether. These waves radiate concentrically in a ripple-like formation from the radio sending station in much the same manner as the waves ensuing from a stone dropt in a quiet pool of water; the gradually expanding waves eventually reaching the receiving station or the shore, as the case may be.

However, a very interesting and ever-present natural phenomena is that of the terrestrial magnetism manifested by the earth and which lends itself to a number of interesting experiments, aside from that of the several interesting actions occurring in using the well-known magnetic compass. We know that the magnetized steel needle of the mariner's compass always points toward the north magnetic pole of the earth.

Turning aside from this well-known phenomenon, we come to a very interesting and, albeit, a practical consideration which involves the actual production of an electric current directly from the cutting of the magnetic lines of force emanating from the earth's surface. Insofar as we know, the earth is actually a gigantic natural magnet.

The earth has a magnetic field, the intensity and direction of which are different in different places. In England the field is northerly and inclined to the horizontal at an angle of about 67 degrees. An ordinary compass, by the direction in which it points, shows that this field is northerly; it fails to show that the field is not horizontal because it is so mounted that it can only swing round in a horizontal plane. If it were free to tilt it would point with its north pole downwards at about 67 degrees.

Consider now a North pole of unit strength. In England this will be pulled northerly and downwards by a force of about half a dyne. Resolve this force into two components (Fig. 1); the one, (V), vertically downwards, the other, (H), horizontal and North. The latter is called the horizontal component of the earth's magnetic field: it is usually denoted by the Symbol H; its value in London is about .186 dyne. It is this horizontal component that regulates the behavior of a compass needle: the vertical component has no effect upon it.

Most college laboratories and high schools are equipt with what is known as an earth coil or earth inductor (Fig. 2). These are generally mounted pivotally on a suitable frame or base so that they can be turned slowly or at fairly high speed, the coil being mounted as shown in the illustration.

If we assume that the coil consists of N turns of wire of radius A cms., and that the total resistance of the inductor, and sensitive galvanometer connected with it, is R ohms, then when the coil is placed at right angles to the earth's field, the horizontal component of which is H = (.186 dyne), the number of lines of force passing thru the inductor will be:  $H N \pi A^2$ , in which  $\pi = 3.1416$ .

If we turn this coil thru 90 degrees, in order that it shall face East and West, no magnetic lines of force will pass thru it. Hence, the electric charge driven around the circuit will be:

$$\frac{\pi A^2 N H}{10^9 R}$$

If we turn the coil thru 180 degrees, the electric charge would have been double this; but if thru an arc of 360 degrees then it would have been zero, as the current would have reversed during the second half of the revolution.

If such an earth coil is constructed having an area of 50 sq. cms., and 40 turns of wire, then when it lies flat upon a table the flux passing thru it will be equivalent to 860 maxwells. If now we

connect the terminals of this coil to a sensitive galvanometer and if the total resistance of the complete circuit is 5 ohms, then the electrical energy induced in this circuit by the magnetic earth flux passing thru the coil axially when it is reversed in position will be  $3.4 \times 10^{-6}$  coulombs.

A piece of iron placed in the neighborhood of a magnet becomes itself a magnet. Now the earth is magnetized and therefore all pieces of iron may be expected to show signs of induced magnetism. To illustrate this perform the following experiment. Take an unmagnetized rod of soft iron. Hold it horizontal in the plane of the meridian and tap it gently with a hammer. Now test both ends by means of a compass needle. You will find that the end which pointed north repels the north end of a compass needle. The rod has therefore been magnetized by induction from the earth. To demagnetize the rod, hold it horizontal pointing east and west and strike it a few times with a hammer. After it is demagnetized, hold it vertical and tap it again with a hammer. It will become magnetized again and the North Pole will be at the lower end. If you care to take the trouble you will also find that practically any vertical piece of iron—a pillar, rail or gas pipe—is magnetized with a North pole at the bottom.

## CONDENSER AND SWITCH HINTS.

Thick slate for the base of a home-made lightning switch is very hard to obtain, but two thin pieces, A, may be used as shown in the cross-section view. The two pieces may be cut from an ordinary school slate. The holes at B B B, for the switch posts, are drilled thru the top piece only, and the holes, C C, for the wood screws are drilled thru both.

A good way to mount a small receiving condenser is shown below. The top and bottom pieces are of thin, polished wood  $\frac{1}{4}$ " larger than the condenser all around. They each have a hole bored at the ends and holes are punched in the condenser lugs to correspond. Two brass bolts, AA, from dry batteries (the lengths of the bolts are greatly exaggerated in drawing) are thrust up thru the holes in the bottom and the nuts, BB, are screwed on. The condenser is now slipped on and the washers, CC, and the nuts, DD, are screwed tight against the lugs so as to make good contact. Put the top on and tighten up the nuts, EE, turn down the nuts, FF, and your condenser is complete.

Contributed by ROGER HACKNEY.

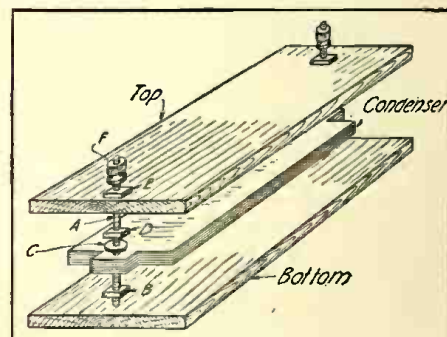

A Good Way in which to Assemble and Clamp Condenser Leaves.

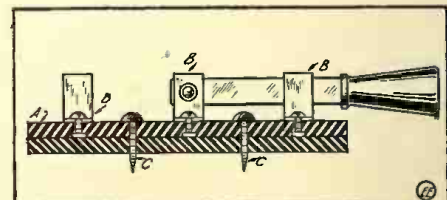

Making a Suitable Lightning Switch Base from Two Thin Pieces of Slate.

## WELLFLEET RADIO OUT OF COMMISSION.

The high-powered radio station here of the Marconi Wireless Telegraph Company of America was out of commission recently as a result of a severe storm. High winds wrecked the antennae of the plant and a number of wires of the Western Union Telegraph Company.

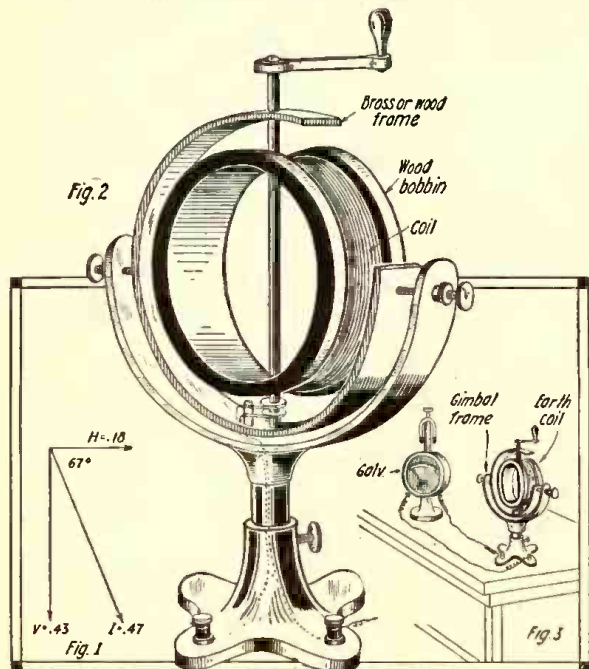

To Demonstrate the Earth's Magnetic Field, Use Is Made of an "Earth" Coil, Shown in the Illustration. This Coil, which May Be Turned or Revolved in Any Plane, Is Connected to a Sensitive Galvanometer. An Experiment That Every Young Electrician Will Find of Extreme Interest.

North and South, demonstrating that there is natural magnetism in the air. To prove that there is magnetism in the air all that is necessary is to take an iron rod, approximately 12" long,  $\frac{3}{8}$ " diameter; wind two layers of No. 20 or No. 22 magnet wire around this rod and connect the two ends of this coil to a galvanometer.

By holding the coil at one end and waving it to and from the ground, the galvanometer will register a positive electric current in one direction and negative in the other. This goes to show that there are lines of force in the air which reach from the North to the South poles of the earth. By waving the coil you cut these magnetic lines.

All that is necessary to transmit signals is to excite these magnetic lines that are already in the air by a higher voltage. The higher voltage would excite these lines of force and turns them into magnetic waves. These waves can be pickt up at a distance with any wireless receiving outfit. This explanation I believe to be the theory of wireless telegraphy, also wireless telephony.

In wireless telephony the magnetic lines in the air are excited by an arc. To demonstrate this I might state that if you take a magnet and hold it to an electric arc the magnet will blow the arc out; but when the arc is burning in the air the magnetic lines of force in the air are much weaker than if you were holding a magnet to the arc. Realizing that the lines of force are weaker than the arc itself, the arc will have a tendency to create magnetic waves, or in other words vibrate the already existing magnetic lines in the air, when modulated by the human voice.

The magnetic lines of force follow the curvature of the earth, as the earth is a magnet, and consequently wireless tele-



# The Quenched Spark Gap

By CHAS. S. BALLANTINE, Radio Research Engineer

**D**URING the past five years the quenched gap has practically been adopted for commercial work by the various radio companies and seems to be giving complete satisfaction, both in regard to operating efficiency and the reduction of decrement of the radiated oscillations. A device such as this, which has past the test

mosphere, composed of about 80 per cent nitrogen, 19 per cent oxygen and 1 per cent argon and other inert gases of this group, in the gap is decomposed by the spark into nitric acid from the nitrogen and water vapor, which unites with the metal of the gap to form *nitric acid gas*. Under certain conditions other chemical reactions may take place, but the final result in any case is the reduction of pressure in the gap and the absence of oxygen in the succeeding discharges. Owing to the fact that all metals contain a certain amount of occluded gas, it is necessary to *season* the gap, by allowing it to operate continuously for a few hours before the note or tone finally becomes clear. If the gap leaks and air is constantly being admitted to the sparking chamber, its presence may be determined by the appearance of the sparking surface, which oxidizes rapidly and becomes covered with a black deposit.

If this occurs, the gap should be thoroughly cleaned with alcohol and a piece of crocus cloth or very fine sand paper, taking care to remove all fine particles of foreign matter before reassembling. The gaskets should be examined and cleaned and if they appear to be perfect, the gap may be reas-

and consequently the adjustments for good working conditions are very much simplified. It is regrettable that this condition is an exception rather than the general rule. In the following discussion it will be assumed that the current supply is drawn from the city mains, and that the phase

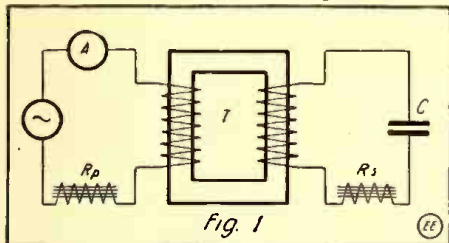

Arrangement of Apparatus for Determining Operating Characteristic of Resonance Transformer.

of actual operating conditions of all kinds, must certainly have sufficient merit to warrant its universal adoption.

In amateur circles very few of these gaps are seen, principally because of the cost of their construction and on account of the fact that the few who have tried them have not made a sufficient study of their operating characteristics to attain the results that should be obtained, and hence have condemned them from the start. The expression of such an opinion, founded on nothing more than a cursory examination of their merits, of course is only a display of ignorance which is shown now and then by a few experimenters, but its effect has been quite extensive. The author knows several people who have never used a gap of this sort, and in fact have never seen one, but who from the start have expressed their opinion of it very forcibly. It is with the intention of helping to correct a few of these fallacies regarding the quenched gap that the following paragraphs have been attempted.

The quenched gap, as most of us know, consists of a number of very short gaps connected in series and made *air-tight*. During the period of the first few sparks across the gap, the oxygen of the air included in the gap is *burnt up*. What probably takes place is as follows: The at-

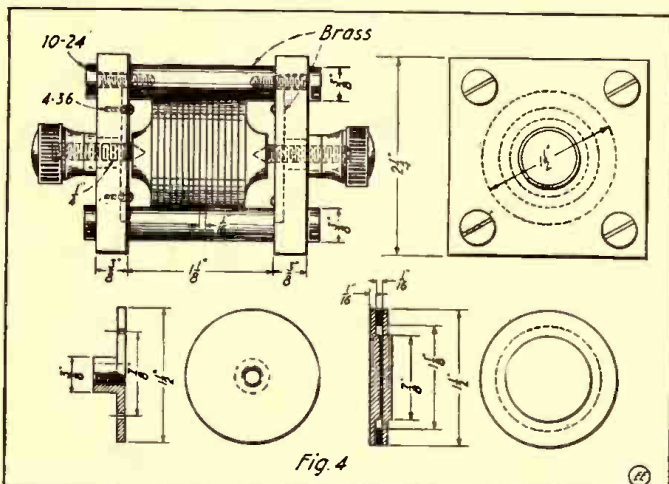

Working Drawings for Building an Efficient Quenched Spark Gap, as Described by Mr. Ballantine.

ssembled, using a little more pressure to bind the plates together. If the gap still continues to leak, replace the gaskets and test it again. Further failure would seem to indicate that the gap was mechanically defective.

In regard to the engineering aspects of quenched gap operation much has been written, and it will be only necessary to review a few of the basic principles here. In the operation of this gap the condenser capacity and phase relations of the various currents in the transformer are of great importance. Generally the amateur must accept his current as he receives it, when the supply is drawn from the city mains. In cases where the generator is located near the apparatus, some control may be had over its operation,

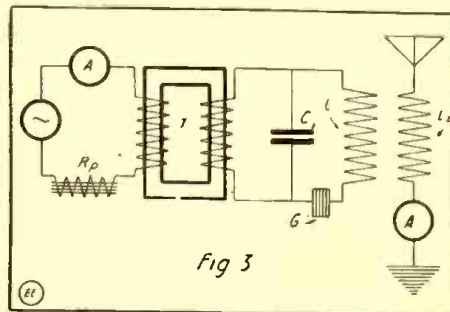

Connections for Quenched Spark Radio Transmitter, as Described in Present Article.

relations of the currents reaching the primary circuit are unknown. The author has used the following method of adjusting the transmitter for some time, with excellent results:

To begin with, it would be well to point out that the method described is one that can be applied to any transmitter, but is particularly useful when the quenched gap is employed, as it is absolutely necessary to have perfect resonance conditions in all circuits with this gap. Otherwise the inferior results referred to in the opening paragraph will probably be obtained.

The apparatus indicated in Fig. 1 are arranged as follows: T represents the low frequency transformer, preferably of the closed core type. An ammeter is connected in the primary circuit as shown at A. The reactance  $R_p$  is inserted in the primary. The secondary reactance shown at  $R_s$  may be omitted, as its effect on the circuit is slight as compared with that of  $R_p$ . This may be seen from the vectors of the ideal transformer. Further, any resistance inserted in the primary side of transformer has an effect equivalent to  
(Continued on page 855)

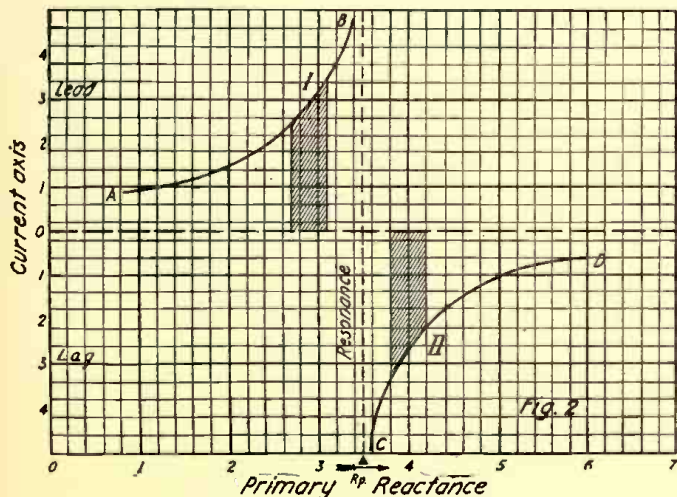

Graphs Showing Off-Resonance Operating Conditions for Well-Tuned Quenched Spark Set.

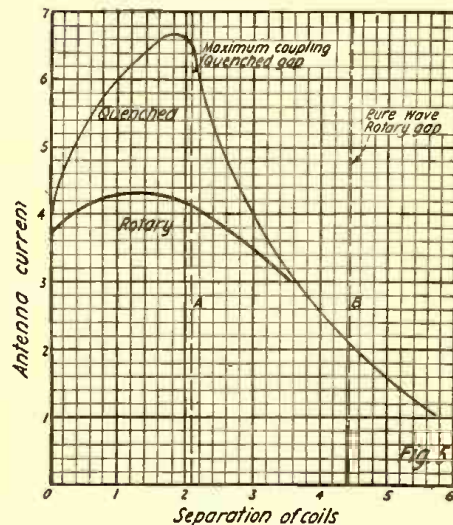

Graphical Representation of Maximum Coupling Permissible for Typical "Quenched" and "Rotary" Gaps.



## Oddities in Telephone and Radio Receivers

THE design of telephone receiver invented by S. G. Brown is shown in plan and section in Figures 1 and 2. Here A is the casing and B the ear-piece, while E is a steel reed, of which one end is fixed to the bridge-piece E' on the casing A, by two adjusting screws E<sup>2</sup>. N and

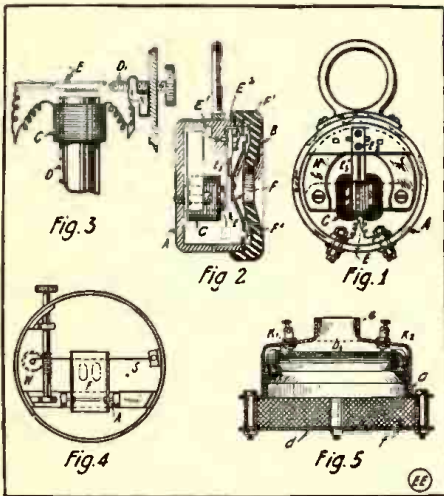

Some Novel Designs of Telephone Receivers Intended for Use in Radio Work. They Include a Monotelephone and a Condenser or Electrostatic Receiver.

S represent the north and south poles of the permanent steel magnet, to which are attached L-shaped pieces, of which the vertical parts constitute the cores D, of the coils C, Fig. 2. The ends of these cores slope towards one another under the reed. The portion E<sup>2</sup> of the reed is cut away as shown to increase its flexibility. A suitable free period is from 800 to 1,200 per second. F is a light, conical aluminum diaphragm (not shown in Fig. 1) attached at its center to the reed E, at a point eccentric with respect to the axis of the core D. The periphery of F is close up against the casing, or may be flexibly attached to the casing by a ring of tissue paper, F'.

The extent to which the reed E, can approach the core D, may be regulated as shown in Fig. 3. If the set screw is tipped with gold or platinum, it may be used for short-circuiting the coil when an unduly heavy current reaches the instrument, as indicated in the sketch. High sensitivity is claimed for this receiver.

### The One-tone or Monotelephone.

When the diaphragm or reed of a telephone receiver is designed to vibrate at a definite frequency, it is said to be tuned. Such a monotelephone designed by Mercadier consists of a thick diaphragm, resting on three points, actuated by a polarized electro-magnet in the usual way. The instrument shown diagrammatically in Fig. 4 is much more sensitive than Mercadier's. The ferrotype diaphragm is fastened between a tight wire and a fixed axle; the pitch is adjusted by a worm wheel that controls the tension of the wire. The electrical parts (not shown in figure) are the same as in ordinary instruments.

Tuned telephones have not proved very useful in connection with musical spark signals. The note of a spark is very rich in over-tones, and when a receiver is tuned to the spark rate, the energy of the fundamental is collected by the diaphragm, and that of the overtones is thrown away. The addition to a telephone receiver of an acoustic resonator has been tried by many. These resonators usually consist of an air-chamber capable of adjustment to the pitch

of the signals, by variations of the internal capacity or of the aperture. They have proved of but little use with spark signals, perhaps for the reason stated in the last paragraph.

### Electrostatic or Condenser Telephone Receivers.

The speaking condenser, since its discovery by William Thomson in 1863, has been investigated and developed by a number of individuals. Pollard and Gardner used a polarized condenser as a telephone receiver in 1874, two years before the discovery of the electro-magnetic receiver by Bell and Gray. Dolbear in 1879, however, was the first to obtain good results. Further progress was made by Dr. Cornelius Herz and Dunand in France. With a condenser of 5 M.F. to 10 M.F. capacity, Herz is said to have succeeded in communicating between Paris and Orleans and between Paris and Tours (1881). Since 1881 J. W. Giltay has contributed considerably to the theory of the speaking condenser (1884, 1897). His investigations deal principally with the polarization of the condensers, and he has shown that unpolarized receivers reproduce all sound an octave above the original.

Workers in more recent times include Argyropoulos, H. Abraham (1907) and Peukert (1909). Ort and Rieger have been concerned with the problem since 1907, and reported their first experiments in "E.T.Z.", 1909. The use of the apparatus has been chiefly simplified by abandoning a battery for charging in favor of a suitable generator. A brief account of some improvements and experiments in this direction are given below.

The first condensers made by Ort and Rieger, were of rectangular shape with stretched paper dielectric. The edges were clamped to avoid noises due to the condenser itself. Circular leaves were afterwards used, consisting of thin tissue paper, saturated with shellac and coated with tinfoil. The condensers were made up from these leaves to about 0.05-0.06 M.F. and were used, among other things, to prove that the condenser as a whole vibrates as a single diaphragm, and that the amount of sound produced depends upon the area of the plates. These paper condensers were never as sensitive as the electro-magnetic telephone, and the low insulation resistance (about 500,000 ohms), was found to be chiefly responsible.

After much experimenting, india-rubber was selected as the best material for the leaves on account of its high insulating properties and low dielectric losses. Mica, although suitable in other ways, was abandoned on account of these losses. The construction of a rubber sheet, condenser telephone is shown in Fig. 5. On an aluminum drum, a, 10 cm. in diameter, the rubber leaves are stretched in the same manner as a drum skin. They are fixed around the periphery so that no irregular vibration can take place. Each leaf is from 0.3 mm. to 0.5 mm. in thickness and weighs about 400 mg. The drum is covered by a cap, e, provided with contacts, K<sub>1</sub> and K<sub>2</sub>, making connection with the plates, while a back plate, d, is fixed at a distance from the case as a reflector for sound from the inner surface of the condenser. The choice of a material for the plates was settled only after many comparative tests, aluminum leaf about 0.001 mm. in thickness being finally adopted as giving the greatest sensitivity. This was attached to the rubber leaves by a special process. The insulation resistance of complete condensers

of 0.088 M.F. made in this way was 400 megohms with 110 volts, and 250 megohms with 240 volts.

The charging or polarizing voltage is of great importance in relation to the volume of sound given by the receiver. With 240 volts the authors found that the volume was equal to that of an electro-magnetic loud-speaking receiver and increased substantially with voltages of 300 and 400 volts.

The variation of capacity with frequency has also been investigated. The capacity was measured between  $w=1,800$  and 6,000 by the Anderson method, and no variation at all could be detected, whether the charging potential of 240 volts was applied or not. This is in contrast with the electro-magnetic telephone, whose inductance and effective resistance vary considerably, in consequence of the natural vibration of the diaphragm. The condenser telephone has no mechanical natural period. Each of the rubber diaphragms has a period of its own, but the periods of the separate diaphragms are all different, so that no definite natural vibration of the whole system is possible. Moreover, the disposition of the several layers gives such good damping that they vibrate aperiodically. There is no rattling, as in the electro-magnetic receiver. Such a receiver has been used in series with radio receiving antennae. These and a number of other interesting devices are described in Dr. Eccle's new work—*Handbook of Wireless Telegraphy and Telephony*.

### A WIRELESS LEAD-IN.

To make this wireless lead-in for windows obtain a square metal rod (brass is best) about 3½ feet long. Bore a hole half inch from each end to admit screws. Now screw this rod on to an insulating base as in figure. This should be longer than the metal bar so it may be screwed to the window frame. Then cut a piece of spring brass about 6 inches long and bend and screw to base as shown on sash. Now screw the bar to the stationary outside frame of the window and the spring to the sash as shown in figure. When you open the window, the slider will slide along the bar. Besides doing away with loose wire, it also permits the window to be opened freely.

Contributed by  
FRANCIS K. FRASER.

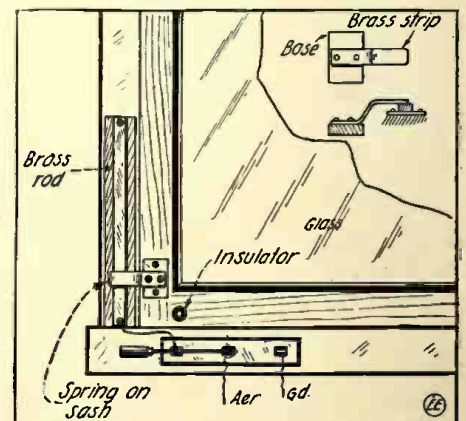

You Can Raise the Window when Fitted With This Clever Lead-In Contact Rail and Shoe, Without Twisting, the Lead-In Rat-tail Cable.

Hongkong, China, has a wireless station with a radius of 500 to 700 miles in daytime and more than 1,300 miles at night.

An electric burglar alarm has been perfected for the chicken coop. Lift the chick and you ring the owner's bell.



# A Rotary Receiving Tuner

By Oliver M. Black

The loose-coupler I am about to describe is of the variometer type. It is very efficient, having no dead-ends or raps, and it is unusually selective. Moreover, it is so

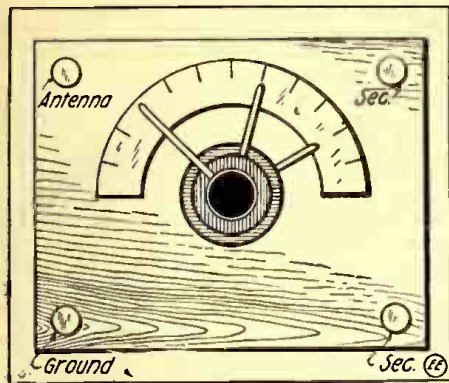

Fig. 1. Front View of Rotary Type, Radio Receiving Tuner. The Relative Position of the Four Windings Can Be Altered Quickly by Means of the Centralized Knob Control.

compact, light and easily portable that it is just the tuner for a portable set. If made from good materials, i.e., mahogany and hard rubber or Bakelite, it adds greatly to the appearance of any station.

The box in which the coils are mounted is preferably of mahogany and measures 10½" high, 12" wide and 10½" deep. The front panel is of hard rubber or Bakelite.

Fig. 1, shows a front view of the case with the knobs, pointers, 180 degree scale and binding-posts.

Fig. 2, shows a side view, with the side of the case removed. Coil G, is 9" in diameter and 2¼" wide. It is wound closely for a distance of 2" with No. 24 B. & S. single silk covered magnet wire, starting ¼" from the edge.

Coil H, is 8½" in diameter and 2¾" wide wound with a few more turns than coil G in order to get the same amount of wire on both coils. Both coils should be wound in the same direction. Coil H, is wound with No. 24 B. & S. single silk covered wire. Coil I, is 8" in diameter by 2¼" wide, wound closely for 2" with the width with No. 30 B. & S. single silk covered wire.

Coil J, is 7½" in diameter and 2¾" wide, wound with a few more turns of wire than coil I, in order to get the same amount of wire on both coils. Coil J is wound with No. 30 B. & S. single silk covered wire. Both coils I and J should be wound in the same direction as coils G and H.

Coil G is fastened directly to the front

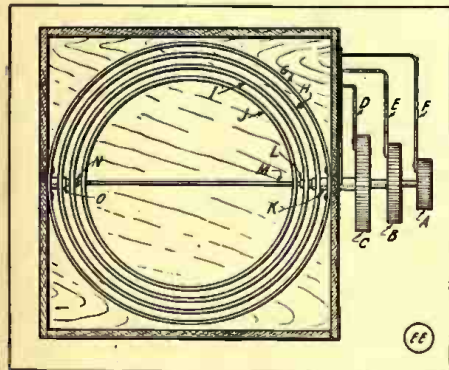

Fig. 2. Side View of Rotary Receiving Tuner of the Modified Variometer Pattern. No Sliders or Switches Are Used.

panel in a vertical position. Coil H is fastened to the brass tube K, on the other end of which is fastened the knob C.

Through the tube K runs another tube L, which will fit snugly and turn rather freely.

To the tube L is fastened the coil I. On the other end of the tube L is fastened the knob B.

Through the tube L runs a rod M, on which is fastened the coil J. On the outer end of this rod M is fastened the knob A. On the back of the case, on the inside, are fastened two tubes N and O of the same size as the tubes L and K respectively, and they act in the same manner as tubes L and K.

To the under sides of the knobs A, B and C are fastened the pointers F, E and D. The connection of the coils are as follows:—The outside end of coil G goes to the aerial binding-post, while the inside end is fastened to the outside end of Coil H. The inside end of coil H goes to the ground binding-post. (See Fig. 3.)

The outside end of coil I goes to one secondary binding-post while the inside end is fastened to the outside end of coil J; the inside end of coil J goes to the other secondary binding-post.

The connections described above should be of flexible, insulated cord with all the joints soldered.

The knobs of A, B and C are preferably of hard rubber. Should the maker wish to mount all instruments in the one cabinet, it is a comparatively simple matter to make the case a little longer, mounting the detector on the outside and the condensers on the inside. Any one carefully following these directions will be able to construct an excellent instrument.

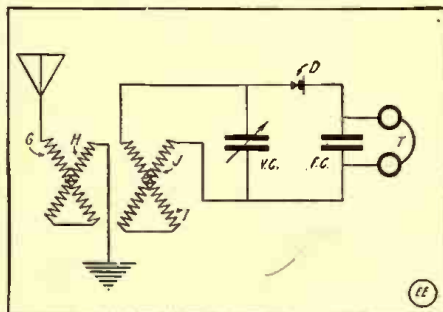

Fig. 3. Hook-Up for Rotary "Switch-less" Tuner.

## PSALM XXIII OF THE RADIO BUG.

1. Wireless is my hobby; I shall want no other.
2. It giveth me good grades in Physics; it leadeth me into the fields of invention.
3. It fireth my ambition; it leadeth me in the realms of science for knowledge's sake.
4. Yea, tho I walk thru the valley of the shadow of gloom, I shall fear no bad temper; thy coils and detectors they comfort me.
5. Thou preparest pleasure before me in the presence of disappointments; thou anointest my head with fame, my "pep" runneth over.
6. Surely pleasure and profit shall follow me all the days of my life, and my "call" shall dwell in the ether of the universe forever.

Contributed by JOHN R. MARTIN.

## REDUCING ROTARY V.C. CAPACITY TO ZERO.

Those using a rotary variable condenser in shunt to the secondary winding of a loose coupler find that with some stations this decreases the strength of signals. This is due to the fact that there is always some capacity in shunt even though the pointer is set at zero. To overcome this I have designed a switch which does away with the trouble without necessitating the use of an extra switch to cut out the condenser.

By studying the drawing the action will be clearly understood. When the pointer is set at zero on the scale the switch inside of the casing is off the sector, thus breaking the circuit between the movable plates and the secondary winding.

The illustration given shows the inside of the condenser.

The idea might also be used on some of the condensers now supplied the ama-

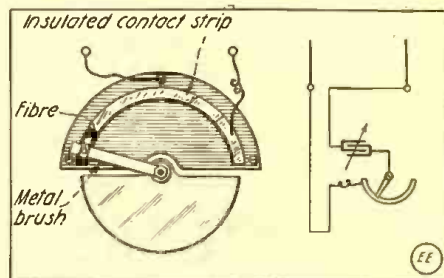

A Clever Scheme Whereby the Capacity of a Variable Condenser May Be Reduced to Zero, by Opening One Side of the Circuit.

teur market, but to my knowledge there is hardly a rotary variable condenser that possesses an absolute zero.

Contributed by SAMUEL GRISCOM.

## A QUICK METHOD OF LAYING OUT ANGLES.

The only things required for the above purpose are a 12" scale and a table of Natural Tangents, such as found in most all engineering hand-books.

Referring to Fig. 1, suppose you want to lay out an angle of 20 degrees and 34 minutes. Consult the table of natural tangents and find corresponding decimal which is .37531; now multiply by A or 5" gives 1.87655 or 1 7/8", and draw line C, which completes your angle of 20° 34'.

Since the tangent of angle 20°, 34' is equal to B ÷ A from trigonometry, therefore to obtain side B it is necessary to multiply the value of the natural tangent or .37531 by 5. Either B or A may be known for producing the angle by substituting the value in the above simple equation.

In fact, the base line A, can be any length, so long as we use the length as our multiplier.

Also such hand-books contain invariably tables of square roots or the square root may be worked out (also by logarithms) applying the usual geometrical law:

$$\begin{aligned} \text{Length } C &= \sqrt{A^2 + B^2} \\ \text{Length } B &= \sqrt{C^2 - A^2} \\ \text{Length } A &= \sqrt{C^2 - B^2} \end{aligned}$$

It should be noted that all such calculations are to be carried out in units of one denomination, as inches, feet, yards, or

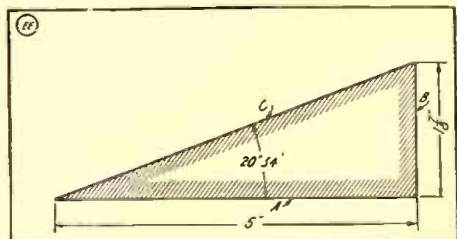

Here Is a Method for Computing Accurately the Height of a Radio Mast or Building, or the Distance Across a Stream.

meters, etc. Never mix up inches with feet.

Contributed by JAMES McINTYRE.

When erecting radio masts and spreaders, do not forget that a coat of paint will help to preserve them, including the iron parts.



**RADIO CONDENSER HINTS.**

When receiving long waves in wireless telegraphy, high capacity variable condensers are often necessary.

As the price increases with the capacity, I devised the scheme here shown diagram-

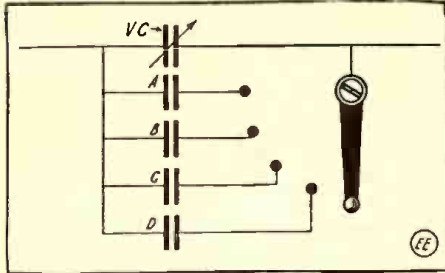

**Clever Scheme for Obtaining Wide Range of Capacities with a Variable Condenser and Several Fixed Units.**

matically. V. C. is a variable condenser of about .0005 Mf. capacity. Fixed condensers A, B, C and D are controlled by multi-point switch M. P. S.

In any case the capacities of these are given in table below.

- (1)=V. C.
- (2)=V. C.+A.
- (3)=V. C.+B.
- (4)=V. C.+C., etc.

From this it is seen that any capacity from approximate zero to maximum may be obtained. Thus if the V. C. capacity is .0005 Mf. any capacity between approximate zero and .0025 Mf. is obtainable (considering that the unit D has a capacity of .002 Mf.).

Contributed by **WALTER D. SHOLL.**

**SILVER WIRE FOR "CAT-WHISKER" CONTACTS.**

I always used a piece of copper wire for the *cat-whisker* on my galena detector and the signals would die out and I would have to press my buzzer test to bring them in again. I decided to try some sterling silver wire and since then I have never had any more trouble. Silver wire is quite stiff and is hard to shake out of adjustment.

Contributed by

**WM. MANSFIELD, JR.**

**AN INEXPENSIVE AERIAL SWITCH.**

A 3 P. S. T. switch and two extra jaws are necessary to construct this switch. The switch and jaws should carry 25 amperes. Second hand ones may be purchased for a small sum at most any electrical shop. Mount the switch, clips up, to your switch-board. See B in illustration. Mount the two extra jaws on a porcelain or a hard rubber base A, and secure to the operating table. Connect as you would any aerial switch. This makes an inexpensive, quick-thrown aerial switch.

Contributed by **GEORGE SWEET.**

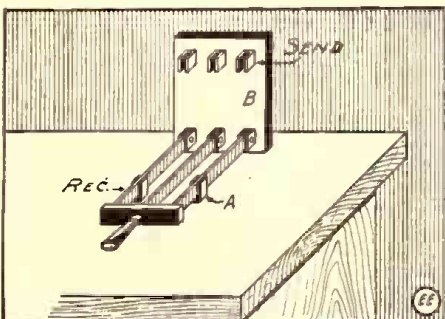

**To Make This Aerial Change-over Switch You Will Require a S. T. 3 Pole Knife Switch and Two Extra Switch Jaws.**

**A BATTERY-LESS ELECTROLYTIC DETECTOR.**

As the title implies, this detector does

not require a battery for efficient operation. Moreover this detector does not require to be adjusted; that is, it is permanent. For the construction of this detector the following materials will be required:

ARTICLE	No.	DIMENSIONS	REMARKS
Small wide mouth bottle	1	About 1 1/2 x 2"	
Rubber stopper	1	To fit bottle	Having 2 holes
Zinc rod	1	3 x 3/8"	
Glass tube	1	6" l. x 3-10" I.D.	
Wollaston wire	-	1/2" long	
Binding post	2		
Wood base	1	4" x 2 1/2" x 5/8"	Stain & Polish
5 cents worth mercury.			5 cents worth sulphuric acid.

Take the glass tube and heat it in a Bunsen burner flame three inches from the end, until it is soft. Care must be taken to revolve the tube during the operation, otherwise it will bend in the middle. When the tube is soft take it out of the flame and pull it out until the heated portion has become quite fine. Then break the tube off about an inch below the point where it begins to decrease in size. Now take the Wollaston wire and remove its silver coating for 1/4 in. by immersing it in nitric acid. When this is done insert the wire (thin end out) into the small end of the tube, letting about 1/8 in. protrude. Now carefully revolve the end of the tube in the flame until the wire is sealed in with the end protruding. After it has cooled break the wire flush with the end of the tube and grind the end on a whetstone.

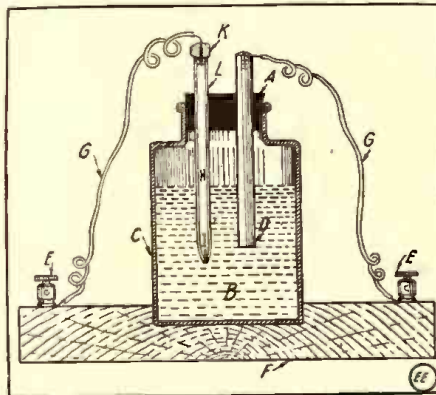

**A Battery-less Electrolytic Detector Comprising a "Sealed Point" Electrode and a Zinc Electrode, Both Immersed in an Acid Solution.**

Finish the tube by filling it with mercury, closing the end with sealing wax after having placed a wire in contact with the mercury. The zinc rod should be amalgamated. The process is as follows: Put a little mercury in a glass vessel and pour dilute sulphuric acid over it. Clean the rod and dip it into the acid until it touches the mercury. Withdraw the rod and invert it; the mercury should run over the rest of the rod; if it does not, repeat the process. To work the detector fill the glass with sulphuric acid 1 part, water about 8 parts; the exact amount to be determined by experiment. Connect as a crystal detector.

Contributed by **L. MOTT-SMITH.**

**LOW FUSION ALLOY TO MOUNT CRYSTALS.**

To make a suitable alloy for the mounting of detector crystals which will melt in hot water melt:

- 50% Bismuth
- 25% Lead
- 12.5% Cadmium
- 12.5% Tin

over a Bunsen burner, being careful not to use too much heat. After all the ingredients have been melted together and cooled the alloy is ready for use.

Contributed by **H. MENDENHALL.**

**A "BABY" AERIAL SWITCH.**

This switch is useful for changing over

from "sending" to "receiving" in buzzer or small spark coil radio transmitting sets. It is made of two S. P. D. T. baby switches screwed together on a block of hard rubber or fiber. This block may be screwed to a sub-base. Two holes are bored in each

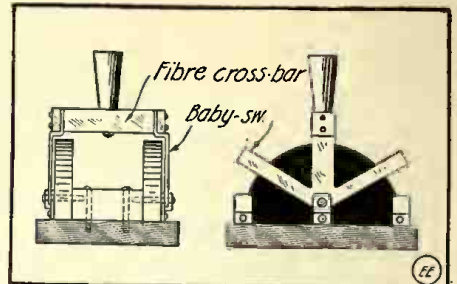

**Using Two "Baby" Knife Switches of the S. P. D. T. Type to Construct a Small Antenna Switch.**

of the handles and the cross-bar of fiber screwed on as illustrated. A standard hard rubber pillar is used for a handle.

Contributed by **FRANCIS R. PRAY.**

**LISTENING TO YOUR OWN SIGNALS WHILE SENDING.**

Amateurs often wish to hear how their own signals sound but have no means of doing so, unless they go to some one's station and have a friend operate their set while they listen in.

But this can be done by means of a telephone. Have your friend who has a radio set and telephone call you up while you are sending and have him hold his radio receiver on the mouthpiece of the telephone. In this way you can hear your signals.

Of course a certain time would have to be arranged between yourself and your friend to do this, but you could tell him by wireless that you wanted to hear your signals and he would call up on the phone or vice versa, if he wanted to hear himself send.

Signals would have to be fairly loud so as to transmit over the telephone.

By this scheme one can adjust his transmitting set and also the sound of the spark very easily.

Contributed by **ARTHUR C. YOUNG.**

**DOUBLE-WAVE AERIAL SWITCH.**

The illustration is practically self-explanatory. This hook-up does away with the amateur's problem of how to use a small and large aerial. When the aerial switch is thrown to the left for "receiving," both sections of the aerial are used, (T fashion); when thrown to the right for "sending," the right-hand portion only of the antenna is used. This latter portion need not be half of the aerial, but under the Radio Law should be sufficient to emit a 200-meter wave. The switch should have

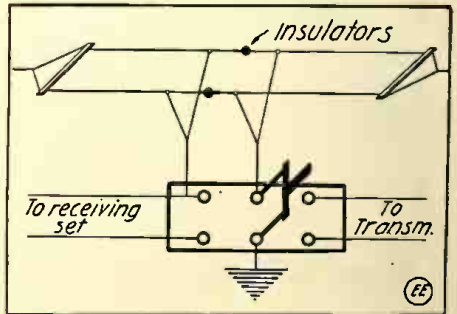

**How to Connect a D. P. D. T. Knife Switch so as to Use a Short Wave for Transmitting and a Long Natural Wave for Receiving.**

well spaced parts, thus adapting it to handle high potentials.

Contributed by **AN EXPERIMENTER.**



# THE CONSTRUCTOR



## Staging a Scientific Entertainment

By RAYMOND FRANCIS YATES

**N**OW that the winter months are here, indoor pleasures and entertainments are being thought of more by wireless and electrical clubs, societies and other organizations, and those who wish to stage

lar to the following: "Ladies and Gentlemen, we are prepared this evening to offer you a few interesting experiments in science, which you can readily appreciate and enjoy without any technical understanding. Many of the experiments to be shown illustrate well-known chemical, physical and electrical laws which play a large part in our every-day life, and which, but for exhibitions of this kind, many of you would be undoubtedly totally ignorant of. A little knowledge of some of the wonderful natural laws that play such a momentous part in our every-day existence makes life seem more interesting, and we sincerely hope that when you leave here this evening you will carry with you a confirmed belief that the domain of science is not merely an uninteresting and unproductive study, but a gigantic and necessary asset to all mankind. The first experiments will be with 200,000 volts of electricity."

that the Tesla coil is left out. After this demonstration the Tesla coil is switched in again and allowed to spark across a gap 8 inches long. The performer then grasps the terminal and allows the current to pass thru his body, the current being allowed to jump to some metallic object held in the hand, much to the surprise and amusement of the audience. The next experiment is

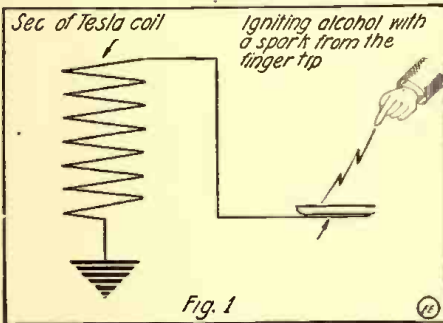

Igniting a Pan of Alcohol by Allowing a High Frequency Spark to Jump to it From the Finger.

an entertainment often find it difficult to obtain something new and original that will offer a good evening's amusement for an audience. There will be found in this article an outline for a scientific entertainment which was recently staged by the author with reassuring success, because it contained something unique and spectacular in the way of scientific exhibitions and which did not demand a technically trained audience to appreciate their truly modern magic. It is a deviation from the path of common amateur drama or comedy, and an exhibition that people of ordinary intelligence can thoroly enjoy. This entertainment should appeal especially to wireless and scientific societies who wish to raise funds in order to improve their financial situation. The description of the experiments employed and the method of presentation follows.

(Lights turned out and music starts.)

The reference made to experimenting with 200,000 volts as the first demonstration involves the use of a Tesla transformer capable of giving a discharge about 10 inches long. A ½ K. W. step-up transformer in connection with a condenser, gap and small Tesla coil tuned to proper resonance should suffice for this demonstration, and, with the lights out and the music playing, a very impressive exhibition can be made by lighting bulbs, drawing long sparks to the body, exciting Geissler tubes wirelessly, etc. For best results one terminal of the Tesla coil should be grounded. The audience is first shown the crashing 10 inch spark by the performer bringing a metallic object near one terminal of the coil. Next, an ordinary 8 c.p. lamp bulb is grasped firmly in the hand and brought into proximity with the coil. The filament lights up and a peculiar blue discharge takes place within the bulb. By previous experimenting many interesting demonstrations can be devised with an electric light bulb and the author will not enter into detail here in describing them. To show the heat of the spark used an alcohol lamp is lighted by the arrangement shown in Fig. 1. Gunpowder can be exploded in the same manner. By placing in the center of the secondary of the Tesla transformer two pieces of cloth, one saturated with ammonia and the other with hydrochloric acid, a large volume of mist will immediately arise, and by switching on the current the cloud will almost immediately condense.

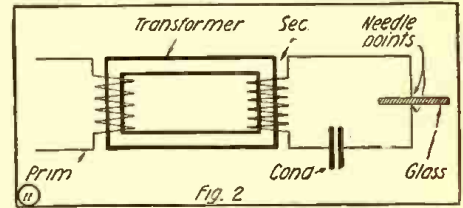

To Show the Great Power of the Transformer a Sheet of Glass is Punctured by Connecting Between the High Voltage Terminals.

called an electric or wireless kiss, in which the chief performer grasps one terminal of the gap, and, with a pin between his teeth, permits the spark to jump from this pin to a pin in his assistant's mouth. This exhibition is sure to bring applause and is a very simple one. Many other interesting experiments can be evolved, many of which will be found in high frequency text-books, such as that by Thomas S. Curtis, also that by H. Transtrom.

The next demonstrations will be in chemistry, the first being with chlorin. The performer announces how chlorin is being used on the battlefields of Europe and then explains that there are many more humane and useful ways man has found to utilize this foul-smelling and death-dealing gas. The ladies are told that if their colored clothes come back from the laundry bleached snow white, that they can attribute it to chlorin. Two large widemouthed bottles of chlorin may be previously prepared by the methods shown

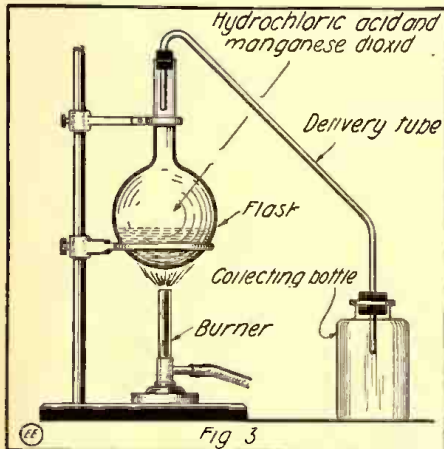

Preparing Chlorin Gas by Chemical Reaction of Hydrochloric Acid and Manganese Dioxide.

A chief demonstrator and two assistants are all the persons required upon the stage. When the curtain rises the chief demonstrator should make an announcement simi-

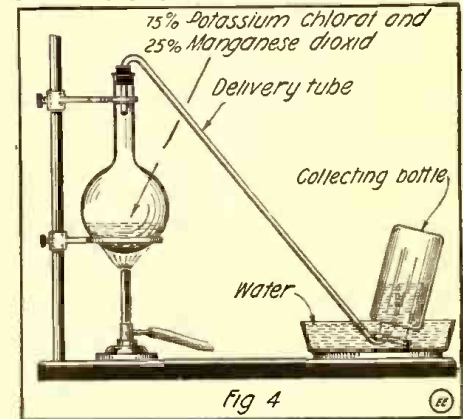

Apparatus Set Up for the Chemical Preparation of Oxygen.

in Fig. 3. If a piece of cheap colored gingham is first immersed in water and then put into a bottle of chlorin for a moment, it will be bleached almost white. Ink writing on paper can be entirely oblit-



erated by this means, and a green leaf from a plant can be made to lose its color rapidly. If a little powdered arsenic or

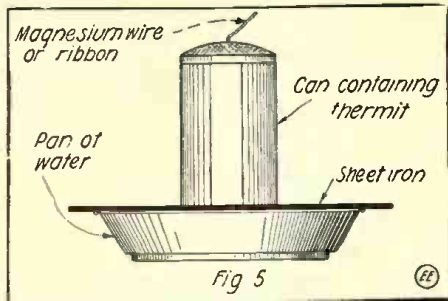

Outfit for demonstrating the tremendous heat produced by "Thermit"—One of the Most Powerful Reactions Known to Modern Science.

antimony is sprinkled into the bottle it will take fire immediately, and if a piece of paper is saturated with warm turpentine it will burn furiously upon being put in the bottle.

The audience is told that the next experiments will be with oxygen and many statements of interest can first be made regarding this gas (see previous numbers of this journal containing "Experimental Chemistry" lessons on Oxygen). A bottle of it is previously prepared as shown in Fig. 4. A small iron wire is heated to redness and then thrust into the bottle of oxygen. It will burn like a match with a great shower of sparks.

Next, the audience is told that common water will be changed into cherry wine. To prepare this trick, obtain a little lime water and a few tablets of phenolphthalein at the drug store. The tablets are put into solution and ten or fifteen drops are placed in the bottom of three table glasses. A water pitcher is filled with water and about a half teacup of lime water is placed in it. When the lime water is poured in the glasses, it will turn to a beautiful crimson color appearing like cherry wine. In a fourth glass, a small amount of concentrated nitric acid is placed, and, upon pouring the prepared water into this, it remains white. This is not mentioned, however, and then the audience is told that the wine will be changed back into water. The glass containing the acid is poured back first, and when the rest are poured in, they will be changed to white again, due to the action of the acid.

The next experiment will be found to be very interesting and the audience is told that they will now witness the method of blowing safes, as related by Arthur B. Reeve in some of his Craig Kennedy stories. 3,500 degrees of heat are developed in this chemical reaction, which is one of the most powerful known to modern science. The reaction referred to is commonly known as *Thermit*, and in place of preparing it, it is advisable to purchase a one pound can already mixed at a chemical supply house. It is arranged as shown in the drawing, Fig. 5, and ignited by a small piece of magnesium wire. To guard against flying sparks, the performer should wear a pair of goggles during this display. The tin can will be entirely melted, and the charge will also fuse its way thru the sheet iron below and fall with a loud hissing sound into the pan of water beneath.

The next is an amusing experiment and may be easily prepared. A piece of white cardboard is written upon with a solution of cobalt chlorid, which will be invisible. The cardboard is then placed in a picture frame with glass in front of it and a piece of sheet asbestos placed behind it. Be sure that the prepared surface is next to the glass. Now put a few tacks in the back of the frame and string some Nichrome wire

upon them. If the wire is connected to the 110-volt circuit it will become heated and the writing in cobalt chlorid will immediately become visible from the effect of the heat.

Electrical experiments are again reverted to, the first one being that *telling fortunes via wireless*. The arrangement is shown in Fig. 6, and as will be seen, it is nothing more than an experiment in induction. An assistant is used here, the chief performer requesting that the audience be perfectly quiet so that the *wireless messages* can be properly read. The primary circuit is run to an adjoining room. Small slips of paper are distributed thruout the audience and all are requested to write some word or phrase upon them. The papers are collected by an assistant and taken to the room where the transmitter is installed. They are then read off to the assistant who is sitting in the cen-

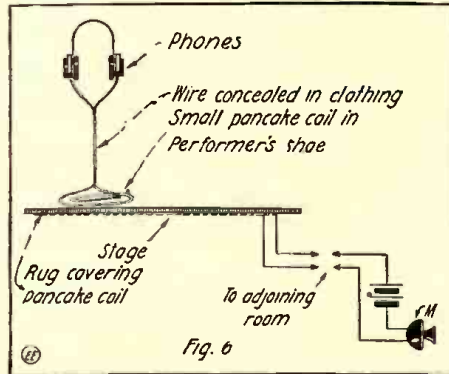

A Wireless "Mind-Reading and Fortune-Telling" Outfit That Operates by Induction Between Two Coils Placed on the Stage or Platform.

ter of the stage, blind-folded and wearing a pair of 'phones. This will cause no little wonderment when the people hear their statements being read, and they will really think that it is accomplished by wireless. In reality it is.

The next experiments are magnetic in na-

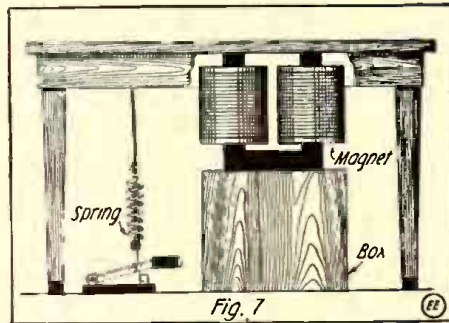

The Popular "Fried Egg" Induction Trick is Accomplish by Holding the Frying Pan Above the Table, Under which a Powerful A. C. Electro-Magnet is Placed.

ture and are probably the most interesting and spectacular of the whole entertainment. A core for a 1/2 K.W. is made or purchased and each leg would with about 250 turns of No. 10 S.C.C. magnet wire. The coil is placed under a thin-topped table as shown. The front of the table is covered to conceal the magnet. The performer takes his place behind the table and taking a small aluminum disk, places it on the table top directly over the poles of the magnet. Using a small wand, he commands the disk to jump into the air, which it does, as the current is sent thru the magnet by tripping the foot-switch. The disk will act as a short-circuited coil, with the same polarity as that of the large magnet, and instead of being attracted, it will be repelled. The audience will be amazed to see this disk thrown into the air without any visible force acting upon it. This can be repeated again and again, and, by careful manipulation, it will

appear as if the wand had absolute control over the disk. If a small iron (better copper) frying-pan is placed over this magnet it will become heated and, while not hot enough to properly fry an egg, a little butter placed in with the egg will sputter and make it appear as if the egg were being fried. A loop of aluminum wire will be thrown into the air much higher than the disk. If about three pounds of annunciator wire is wound into a coil and connected to a lamp, the lamp will light when brought into the field of the magnet. This experiment can be made to appear still more mysterious by placing the coil and lamp under water in a large glass jar. If a coil of a few turns of No. 4 magnet wire is made and connected to a fuse wire, enough current will be induced into the coil to *blow* the fuse wire. The audience will be astonished and wonder where the large amount of current is really coming from.

The next demonstration is the concluding one. It is that of controlling apparatus by wireless. A sensitive telegraph relay and coherer will be required, and are connected as shown. The transformer, cap and condenser of the Tesla outfit are used for the transmitter. A small table containing the apparatus to be actuated is placed in the back of the room and the devices are controlled from the stage. The audience is shown that no wires are connected to the table. After lighting lamps, running motors and ringing bells, a small cannon is exploded and at the same instant a battery motor may be thrown into operation, hoisting an American flag and the orchestra starts playing the National Anthem. A method of hoisting the flag and exploding the cannon are shown in Fig. 8. The details of some of the experiments can well be worked out by the ingenious reader, who will gain considerable knowledge thereby. We can all do the simple stunts—but the harder ones call for more concentrated effort and always repay one for the trouble taken to work them out successfully.

CONNECTING EXTENSION BELL TO A TELEPHONE.

Our telephone being located downstairs, it was often impossible to hear it ring when the people were on the upper floors. To overcome this, a bell was connected from the 'phone to the upper stories in this manner: A wire was run from a telephone gong to an ordinary vibrating bell upstairs, with one or two cells for battery, and back again to the clapper so that the clapper striking the gong, to which the wire was connected, would rapidly open and close the circuit and sound the different rings upstairs. A switch was also inserted, in the circuit, but can be dispensed with.

Contributed by A. BELL GREENE.

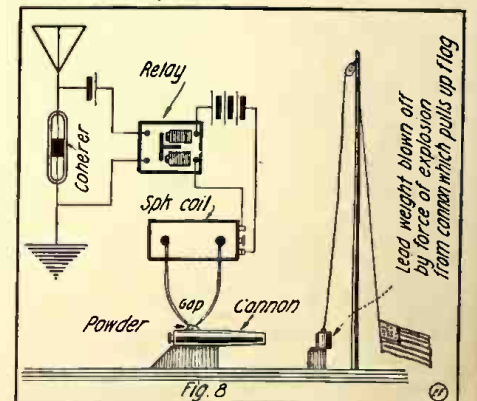

Raising a Miniature Flag by Radio. Spark Coil Fires Cannon Which Blows Weight Off Block, Releasing Flag.



**A BALANCED RELAY BURGLAR ALARM SYSTEM.**

**A**N alarm system for burglar protection consists of three main parts in a balanced system. The contacts, the relay and the alarm constitute the main sections and we will deal with them in this order.

The contacts here utilized are of both

the tapper arm *slightly* it will be caused to drop to one side.

Two contacts are mounted on the wood base at either side of the tapper. Adjusting screws are provided as shown. These screws, as well as the tapper arm, should be silver or platinum tipped. This is not to be adjusted until wired into the circuit.

The alarm signal is usually a bell or buzzer, but where the house is wired for electric lights, the scheme of turning on every light on the premises is a very good one in addition to the bell. Therefore two hook-ups are shown, one using the regular bell (Fig. 4); the other (Fig. 5) switching on the lights so that they cannot be turned off in any of the rooms, but only by resetting the alarm circuit-closer.

The circuit is wired with No. 18 cotton covered bell wire and a resistance of 20 ohms is connected in at the far end of the line. The relay is then adjusted so that the tapper arm lies between the two contacts. Should the circuit be closed or in fact tappered with in any way the tapper will fall against one or the other contact and will stay there, due to the special wiring. Thus the alarm will be given even should the circuit return instantly to its original condition.

The closing of the balanced relay operates the second pony relay, switching on the lights or ringing the alarm bell as desired.

The batteries for this system should be copper sulfate cells. They can be easily made by following the sketch, Fig. 6, and should cost less than 50c. a piece; three or four being sufficient. Dry cells can be used for operating the bell.

Contributed by **THOMAS W. BENSON.**

**A PACHYTROP FOR SERIES OR PARALLEL CONNECTION.**

A Pachytrop is an apparatus which enables us to connect the cells of a storage or primary battery in series or in parallel by simply manipulating a single handle or by similar means. An instrument of this description is extremely useful when a storage battery is being charged continuously by a gravity or copper-oxid battery. If the storage battery consists of six cells the E.M.F. is about 12 volts; the E.M.F. of the three gravity cells is only 2.7 volts, which means that we will have to connect our storage cells in parallel.

If we should want to use the storage battery with an E.M.F. of 12 volts, e.g., cells in series, it would be necessary to change all connections and after the experiment, when the charging is to begin again, change them back again to parallel. This is where the Pachytrop comes in.

By simply inserting two different connectors we can change the E.M.F. from 2 to 12 volts. The Pachytrop described here consists of a strip of wood, A, which carries six brass strips, B, on each side. The brass strips, B, on one side are connected to the positive electrodes of our storage cells, while the strips on the other

a brass strip, F, running the entire length of the parallel part of H. Each brass strip, F, is connected to a binding post, K.

It will be evident that if we insert this connector, 1, between the brass strips, B, then all positive and all negative electrodes will be in parallel. By inserting the connector 2 we get 12 volts; that means all cells in series.

This second connector consists of a similar strip of wood, M, to which small brass clips, G, are screwed; these strips are connected as shown and the two remaining ones connected to two binding posts, L. Its construction will now be described.

First, plane a piece of wood, A, to the dimensions given, 6½" long, 1½" wide and ½" thick. Next procure some brass or copper strips ½" wide by 1/16" thick and cut the strips, B, of which 12 are required. Drill a hole 3/16" dia. thru B,

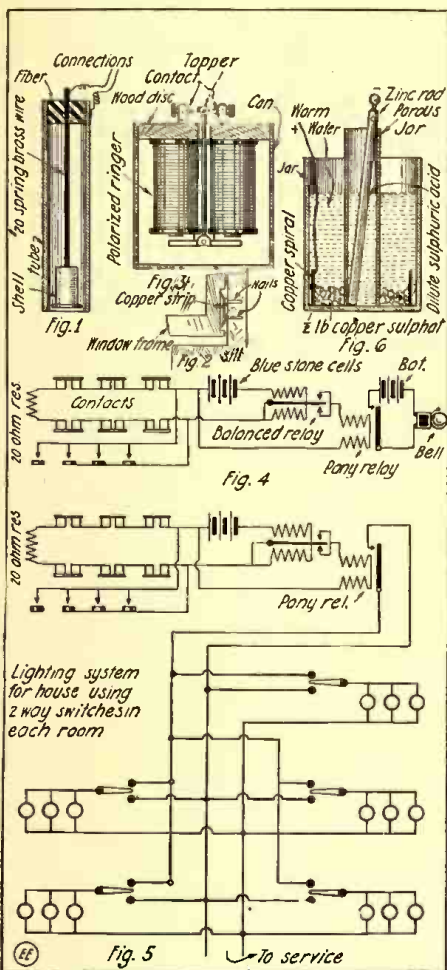

Constructional and Wiring Details for a Doubly Sure Burglar Alarm System, Utilizing a Balanced Relay Made from a Polarized Telephone Ringer.

the open and closed-circuit types. The former are made as shown in Fig. 1. A number of brass tubes, ½" inside diameter and 6" long, are first obtained. An insulating block supporting a spring brass wire and contact is mounted in one end of the tube.

The contact may consist of a 38-calibre cartridge shell soldered to the end of the wire. The connections are then soldered to the wire and tube.

These contacts may be put in the most unusual places: the hems of curtains, back corners of drawers and by drilling a hole into the woodwork of the door they can be readily inserted. A door accidentally left ajar is thus protected, since moving it would cause the shell to touch the tube due to inertia, and the alarm would be sounded.

The closed-circuit contacts may conveniently take the form of two nails or screws over which a metal short-circuiting shoe passes. Fig. 2 shows them applied to windows, but shutters and doors may be protected in the same way.

The relay will now receive attention. A very good one can be made from an ordinary polarized telephone bell ringer. Obtain a can 4" in diameter and as deep; cut a lid from ½" wood to fit inside. Mount the ringer inside the can as shown with tapper extending (Fig. 3). By bending

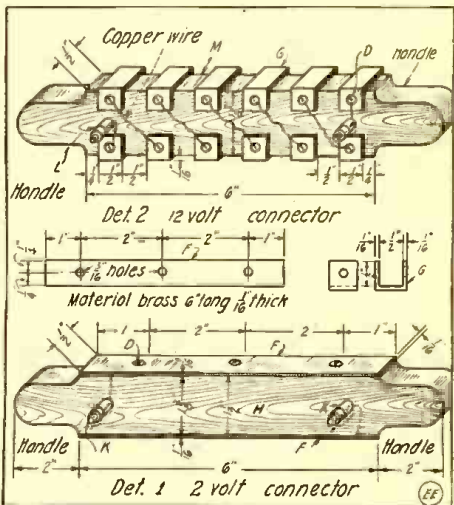

Different Styles of Switch Blocks for Series-parallel Battery Pachytrop.

at a distance of ¼" from the bottom and fix the strips B as shown to the board A, using wood screws D. The strips are spaced ½" apart and the board A may be screwed to the accumulator box by wood screws C. Bend the tips of the strips slightly outwards as this makes it easier to introduce the connectors.

For the connector 1 take a piece of wood H and plane down to 10" long, 1¾" wide by ½" thick. Two handles, 2" long should then be cut on this piece while the center part is left parallel. A brass strip ½" wide by 1/16" thick is cut as shown in detail of F and screwed to H.

Connect each strip to a binding post K and connector 1 is completed. Connector 2 is made in a similar manner, using clips G bent from the same strip as used for F and connecting them as shown. The two remaining clips are connected to two binding posts, L.

Contributed by **C. A. OLDROYD.**

**DID YOU SAY SILVER-PLATED WINDINGS? WELL, HERE'S HOW.**

Recently I broke the "G" string on my violin. It is a cat-gut string wound with silver-plated copper ribbon about 1/64 inch wide. Upon trial I found this to be very satisfactory, as it shows a very low ohmic resistance.

These strings may be secured from any music supply house, one of them advertising a gut string wound with pure silver wire at 35 cents. The silver plated steel "E" strings can be used but the steel makes the resistance rather high. The fact that the radio-currents remain on the outer surface of conductors might render them as efficient as the "G" strings.

Contributed by **WM. B. SPURRIER.**

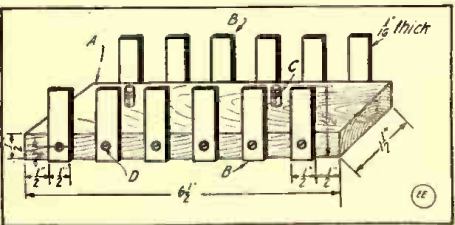

Detail of Pachytrop Stationary Contact Block and Metal Jaws, Between which Rests the Removable Switch Block.

side are connected to the negative electrodes. The connector, 1, which gives 2 volts, e.g., all cells in parallel, consists of a piece of wood, H, on each side of which is



# Testing High Voltages With Spark Gaps

The A.I.E.E. recommend these rules for testing high voltages with a spark gap.

*Measurements with Spark Gaps.* If proper precautions are observed, spark gaps may be used to advantage in checking the calibration of voltmeters when set up for the

more than 0.1 per cent and the curvature, measured by a spherometer, should not vary more than 1 per cent from that of a true sphere of the required diameter.

*In using the spherometer* to measure the curvature, the distance between the points of contact of the spherometer feet should be within the following limits:

TABLE 2.  
Spherometer Specifications

Diameter of Sphere in mm.	Distance between contact points in mm.	
	Maximum	Minimum
62.5	35	25
125	45	35
250	65	45
500	100	65.

*In using Sphere Gaps* constructed as above, it is assumed that the apparatus will be set up for use in a space comparatively free from external dielectric fields. Care should be taken that conducting bodies forming part of the circuit, or at circuit potential, are not so located with reference to the gap that their dielectric fields are superposed on the gap; e.g., the protecting resistance should not be arranged so as to present large masses or surfaces near the gap, even at a distance of two sphere diameters.

In case the sphere is grounded, the spark point of the grounded sphere should be approximately five diameters above the floor or ground.

TABLE 3.

Sphere Gap Spark-Over Voltages.

The sparking distances between different spheres for various r.m.s. sinusoidal voltages shall be assumed to be as follows:

(At 25° C. and 760 mm. barometric pressure)

Kilovolts	Sparking Distance in Millimeters.							
	62.5 mm.		125 mm.		250 mm.		500 mm.	
	One sphere grounded	Both spheres insulated	One sphere grounded	Both spheres insulated	One sphere grounded	Both spheres insulated	One sphere grounded	Both spheres insulated
10	4.2	4.2	.....	.....	.....	.....	.....	.....
20	8.6	8.6	.....	.....	.....	.....	.....	.....
30	14.1	14.1	14.1	14.1	.....	.....	.....	.....
40	19.2	19.2	19.1	19.1	.....	.....	.....	.....
50	25.5	25.0	24.4	24.4	.....	.....	.....	.....
60	34.5	32.0	30.	30.	29	29	.....	.....
70	46.0	39.5	36	36	35	35	.....	.....
80	62.0	49.0	42	42	41	41	41	41
90	.....	60.5	49	49	46	45	46	45
100	.....	.....	56	55	52	51	52	51
120	.....	.....	79.7	71	64	63	63	62
140	.....	.....	108	88	78	77	74	73
160	.....	.....	150	110	92	90	85	83
180	.....	.....	.....	138	109	106	97	95
200	.....	.....	.....	.....	128	123	108	106
220	.....	.....	.....	.....	150	141	120	117
240	.....	.....	.....	.....	177	160	133	130
260	.....	.....	.....	.....	210	180	148	144
280	.....	.....	.....	.....	.....	250	203	163
300	.....	.....	.....	.....	.....	.....	231	177
320	.....	.....	.....	.....	.....	.....	265	194
340	.....	.....	.....	.....	.....	.....	.....	214
360	.....	.....	.....	.....	.....	.....	.....	234
380	.....	.....	.....	.....	.....	.....	.....	255
400	.....	.....	.....	.....	.....	.....	.....	276
.....	.....	.....	.....	.....	.....	.....	.....	257

purposes of high-voltage tests of the insulation of machinery.

*Ranges of Voltages.* For the calibrating purposes set forth the sphere gap shall be used for voltages above 50 kv., and is to be preferred down to 30 kv. The needle spark gap may, however, be used for voltages from 10 to 50 kv.

*The Needle Spark Gap.* The needle spark gap shall consist of new sewing needles, supported axially at the ends of linear conductors which are at least twice the length of the gap. There must be a clear space around the gap for a radius of at least twice the gap length. The sparking distances in air between No. 00 sewing needlepoints for various root-mean-square sinusoidal voltages are as follows:

TABLE 1.

Needle Gap Spark-Over Voltages.  
(At 25° C. and 760 mm. barometer).

R. M. S. Kilovolts	Millimeters	R. M. S. Kilovolts	Millimeters
10	11.9	35	51
15	18.4	40	62
20	25.4	45	75
25	33	50	90
30	41	.....	.....

The above values refer to a relative humidity of 80 per cent. Variations from this humidity may involve appreciable variations in the sparking distance.

*The Sphere Spark Gap.* The standard sphere spark gap shall consist of two suitably mounted metal spheres. When used as specified below, the accuracy obtainable should be approximately 2 per cent.

No extraneous body, or external part of the circuit, shall be nearer the gap than twice the diameter of the spheres. By the "gap" is meant the shortest path between the two spheres.

The shanks should not be greater in diameter than 1/5 the sphere diameter. Metal collars, etc., through which the shanks extend, should be as small as practicable and should not, during any measurement, come closer to the sphere than the maximum gap length used in that measurement.

The sphere diameter should not vary

The sphere gap is more sensitive than the needle gap to momentary rises of voltage and the voltage required to spark over the gap should be obtained by slowly closing the gap under constant voltage, or by slowly raising the voltage with a fixed setting of the gap. Open arcs should not be permitted in proximity to the gap during its operation, as they may affect its calibration.

When the variation from sea level is not great, the relative air density may be used as the correction factor; when the variation is great, or greater accuracy is desired, the correction factor corresponding to the rela-

(Continued on page 858)

## FIXING PRINTS.

Ammonia forms one of the best fixing agents for prints and is to a certain extent superior to hyposulfite of soda used for this purpose. It gives clear whites and dissolves very little of the silver.

The solution consists of 1 part of ammonia to 5 parts of water. The length of fixing should not be more than 15 minutes. Another advantage is that the prints do not require much washing after fixing.

Contributed by THOS. W. BENSON.

## COMBINATION ELECTRIC LOCK.

In my home I have a workshop which I call my "laboratory" and I have a Yale lock on the door. I had a lot of trouble keeping my younger brother out when I was out of town, as he found my key and made one for himself. I came home often and found things missing or disturbed, so I found it necessary to put on some other kind of lock which would keep him guessing for a while.

I made a solenoid coil A, 3 inches long, with a 3/4-inch core of thin brass tubing, and wound it with twenty-four layers of No. 18 enamel wire and also one with a 5/16 inch hole wound with No. 22 wire (B in Fig.). This one was 1 1/2 inches long and 1 1/8 inches in diameter.

Boring a 3/16 inch hole in the handle of the lock at an angle of 45 degrees from the bottom, I placed a 3/16 inch rod in it and let it extend out 1 inch towards the back, so that when the rod is lifted the latch or locking bar is drawn in. There is drilled a No. 38 hole in the extending end of this rod and the sides are flattened by filing.

I then mounted the large solenoid coil on suitable brackets on the door with its armature only in the coil one-half inch. I left room for a 3 inch connecting rod between armature and rod in the knob. I used 5 dry cells and 2 brass screws in the door on the outside, so that by short-circuiting the screws the magnet lifted the rod and unlocked the door.

This you will notice does not keep my brother or others from entering if they have the key, and as I did not want to remove the key barrel from the lock, in case

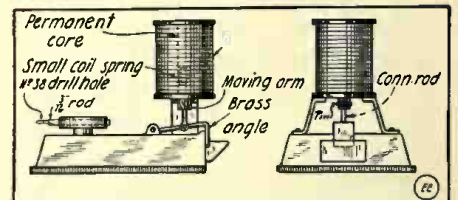

Side and End Views of Magnetic Release for Auxiliary Locking Arm Fitted to a "Yale" Lock.

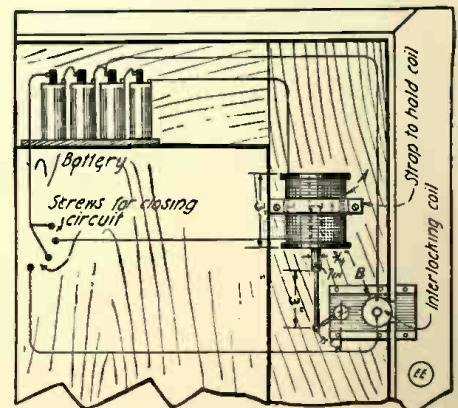

How a Solenoid Magnet Is Employed to Turn the Latch Spindle when the Circuit Is Closed at a Secret Contact.

he electric opener should not work, I used the small brass angle, a detail of this idea appearing in the figure.

Contributed by ALLEN DALE.



# Standardization Rules, Electrical Engineers.

# American Institute of Definitions (Revised)

The following definitions are intended to be practically descriptive, rather than scientifically rigid.

**CURRENT, E.M.F. and POWER.** (The definitions of currents given below apply also, in most cases, to electromotive force, potential difference, magnetic flux, etc.)

**Direct Current.** A unidirectional current. As ordinarily used, the term designates a practically non-pulsating current.

**Pulsating Current.** A current which pulsates regularly in magnitude. As ordinarily employed, the term refers to unidirectional current.

**Continuous Current.** A practically non-pulsating direct current.

**Alternating Current.** A current which alternates regularly in direction. Unless distinctly otherwise specified, the term "alternating current" refers to a periodic current with successive half waves of the same shape and area.

**Oscillating Current.** A periodic current whose frequency is determined by the constants of the circuit or circuits.

**Cycle.** One complete set of positive and negative values of an alternating current.

**Electrical Degree.** The 360th part of a cycle.

**Period.** The time required for the current to pass through one cycle.

**Frequency.** The number of cycles or periods per second. The product of  $2\pi$  by the frequency is called the angular velocity of the current.

**Root-Mean-Square or Effective Value.** The square root of the mean of the squares of the instantaneous values for one complete cycle. It is usually abbreviated r.m.s. Unless otherwise specified, the numerical value of an alternating current refers to its r.m.s. value. The r.m.s. value of a sinusoidal wave is equal to its maximum, or crest value, divided by  $\sqrt{2}$ . The word "virtual" is sometimes used in place of r.m.s., particularly in Great Britain.

**Wave-Form or Wave-Shape.** The shape of the curve obtained when the instantaneous values of an alternating current are plotted against time in rectangular co-ordinates. The distance along the time axis corresponding to one complete cycle of values is taken as  $2\pi$  radians, or 360 degrees. Two alternating quantities are said to have the same wave-form when their ordinates of corresponding phase (see Phase) bear a constant ratio to each other. The wave-shape, as thus understood, is therefore independent of the frequency of the current and of the scale to which the curve is represented.

**Simple Alternating or Sinusoidal Current.** One whose wave-shape is sinusoidal.

Alternating-current calculations are commonly based upon the assumption of sinusoidal currents and voltages.

**Phase.** The distance, usually in angular measure, of the base of any ordinate of an alternating wave from any chosen point on the time axis, is called the phase of this ordinate with respect to this point. In the case of a sinusoidal alternating quantity, the phase at any instant may be represented by the corresponding position of a line or vector revolving about a point with such an angular velocity ( $\omega = 2\pi f$ ), that its projection at each instant upon a convenient reference line is proportional to the value of the quantity at that instant.

**Non Sinusoidal Quantities.** Quantities that cannot be represented by vectors of constant length in a plane. The following definitions of phase, active component, reactive component, etc., are not in general applicable thereto. Certain "equivalent" values, as defined below, may, however, be used in many instances, for the purpose of approximate representation and calculation.

**Crest-Factor or Peak-Factor.** The ratio of the crest or maximum value to the r.m.s. value. The crest factor of a sine-wave is  $\sqrt{2}$ .

**Form Factor.** The ratio of the r.m.s. to the algebraic mean ordinate taken over a half-cycle beginning with the zero value. If the wave passes through zero more than twice during a single cycle, that zero shall be taken which gives the largest algebraic means for the succeeding half-cycle. The form factor of a sine-wave is 1.11.

**Equivalent Sine-Wave.** A sine-wave which has the same frequency and the same r.m.s. value as the actual wave.

**Phase-Difference: Lead and Lag.** When corresponding cyclic values of two sinusoidal alternating quantities of the same frequency occur at different instants, the two quantities are said to differ in phase by the angle between their nearest corresponding values; e.g., the phase angle between their nearest ascending zeros or between their nearest positive maxima. That quantity whose maximum value occurs first in time is said to lead the other, and the latter is said to lag behind the former.

**Non-Inductive Load and Inductive Load.** A non-inductive load is a load in which the current is in phase with the voltage across the load. An inductive load is a load in which the current lags behind the voltage across the load. A condenser or anti-inductive load is one in which the current leads the voltage across the load.

**Power in an Alternating-Current Circuit.** The average value of the products of the coincident instantaneous values of the current and voltage

for a complete cycle, as indicated by a watt-meter. **Volt-Amperes or Apparent Power.** The product of the r.m.s. value of the voltage across a circuit by the r.m.s. value of the current in the circuit. This is ordinarily expressed in kv-a.

**Power Factor.** The ratio of the power to the volt-amperes. In the case of sinusoidal current and voltage, the power factor is equal to the cosine of their difference in phase.

**Equivalent Phase Difference.** When the current and e.m.f. in a given circuit are non-sinusoidal, it is customary, for purposes of calculation, to take as the "equivalent" phase difference, the angle whose cosine is the power factor (see above) of the circuit. There are cases, however, where this equivalent phase difference is misleading, since the presence of harmonics in the voltage wave, current wave, or in both, may reduce the power factor without producing a corresponding displacement of the two wave forms with respect to each other; e.g., the case of an a.c. arc. In such cases, the components of the equivalent sine waves, the equivalent reactive factor and the equivalent reactive volt-amperes may have no physical significance.

**Single-Phase.** A term characterizing a circuit energized by a single alternating e.m.f. Such a circuit is usually supplied through two wires. The currents in these two wires, counted positively outwards from the source, differ in phase by 180 degrees or a half-cycle.

**Three-Phase.** A term characterizing the combination of three circuits energized by alternating e.m.f.'s, which differ in phase by one-third of a cycle; i.e., 120 degrees.

**Quarter-Phase, also called Two-Phase.** A term characterizing the combination of two circuits energized by alternating e.m.f.'s which differ in phase by a quarter of a cycle; i.e., 90 degrees.

**Six-Phase.** A term characterizing the combination of six circuits energized by alternating e.m.f.'s, which differ in phase by one-sixth of a cycle; i.e., 60 degrees.

**Polyphase.** A general term applied to any system of more than a single phase. This term is ordinarily applied to symmetrical systems.

**Plant Factor.** The ratio of the average load to the rated capacity of the power plant, i.e., to the aggregate ratings of the generators.

**The Demand of an Installation or System** is the load which is drawn from the source of supply at the receiving terminals averaged over a suitable and specified interval of time. Demand is expressed in kilowatts, kilovolt-amperes, amperes, or other suitable units.

**The Maximum Demand of an Installation or System** is the greatest of all the demands which have occurred during a given period. It is determined by measurement, according to specifications, over a prescribed time interval.

**Demand Factor.** The ratio of the maximum demand of any system or part of a system, to the total connected load of the system, or of the part of system, under consideration.

**Magnetic Degree.** The 360th part of the angle subtended, at the axis of a machine, by a pair of its field poles. One mechanical degree is thus equal to as many magnetic degrees as there are pairs of poles in the machine.

**The Variation in Alternators or alternating-current circuits** in general, is the maxi-

mum angular displacement, expressed in electrical degrees (one cycle = 360 deg.) of corresponding ordinates of the voltage wave and of a wave of absolutely constant frequency equal to the average frequency of the alternator or circuit in question, and may be due to the variation of the prime mover.

**The Pulsation in Prime Movers, or in the alternator connected thereto.** The ratio of the difference between the maximum and minimum velocities in an engine-cycle to the average velocity.

**Capacity.** The two different senses in which this word is used sometimes leads to ambiguity. It is therefore recommended that whenever such ambiguity is likely to arise, the descriptive term *power capacity* or *current capacity* be used, when referring to the power or current which a device can safely carry, and that the term "Capacitance" be used when referring to the electrostatic capacity of a device.

**Resistor.** A device, heretofore commonly known as a resistance, used for the operation, protection, or control of a circuit or circuits.

**Reactor.** A coil, winding or conductor, heretofore commonly known as a reactance coil or choke coil, possessing inductance, the reactance of which is used for the operation, protection or control of a circuit or circuits.

**Efficiency.** The efficiency of an electrical machine or apparatus is the ratio of its useful output to its total input.

[For the complete revised Standardization Rules of the A.I.E.E. address the Secretary, Mr. F. L. Hutchinson, 33 W. 39th St., New York.—Ed.]

TABLE I.  
Symbols and Abbreviations.

Name of Quantity.	Symbol for the Quantity.	Unit.	Abbreviation for the Unit.
Electromotive force, abbreviated e.m.f.	$E, e$	volt	....
Potential difference, abbreviated p.d.	$V, v$ or $E, e$	"	....
Voltage.....	$E, e$ or $V, v$	"	....
Current.....	$I, i$	ampere	....
Quantity of electricity.....	$Q, q$	{ coulomb, ampere-hour }	....
Power.....	$P, p$	watt	....
Electrostatic flux.....	$\Psi$	....	....
Electrostatic flux density.....	$D$	....	....
Electrostatic field intensity.....	$F$	....	....
Magnetic flux.....	$\Phi, \phi$	maxwell**	....
Magnetic flux density.....	$B, b$	gauss**	....
Magnetic field intensity.....	$H, \mathcal{H}$	{ gilbert per centimeter or gauss††	gilbert per cm.
Magnetomotive force, abbreviated m.m.f.....	$\mathcal{F}$	gilbert*	....
Intensity of magnetization.....	$\mathcal{H}$	....	....
Susceptibility.....	$k = J/H$	....	....
Permeability.....	$\mu = B/H$	....	....
Resistance.....	$R, r$	ohm	....
Reactance.....	$X, x$	....	....
Impedance.....	$Z, z$	....	....
Conductance.....	$G, g$	mho	....
Susceptance.....	$B, b$	"	....
Admittance.....	$Y, y$	"	....
Resistivity.....	$\rho$	{ ohm-centi- meter }	ohm-cm.
Conductivity.....	$\gamma$	{ *mho per centi- meter }	mho per cm
Dielectric constant.....	$\epsilon$ or $k$	....	....
Reluctance.....	$\mathcal{R}$	....	....
Capacitance (Electrostatic capacity).....	$C$	farad	....
Inductance (or coefficient of self induction).....	$L$	henry	....
Mutual Inductance (or coefficient of mutual induction).....	$M$	henry	....
Phase displacement.....	$\theta, \psi$	{ degree or radian }	....
Frequency.....	$f$	cycle per second	~
Angular velocity.....	$\omega$	{ radian per second }	....
Velocity of rotation.....	$n$	{ revolution per second }	rev. per sec.
Number of conductors or turns.....	$N$	{ convolution or turns of wire }	....
Temperature.....	$T, t, \theta$	degree centi- grade	°C.
Energy, in general.....	$U$ or $W$	joule, watt-hour	....
Mechanical work.....	$W$ or $A$	joule, watt-hour	....
Efficiency.....	$\eta$	per cent	....
Length.....	$l$	centimeter	cm.
Mass.....	$m$	gram	g.
Time.....	$t$	second	sec.
Acceleration due to gravity.....	$g$	{ centimeter per second per second }	cm. per sec. per sec. }
Standard acceleration due to gravity (at about 45 degrees latitude and sea level) equals 980.665 f.....	$g_0$	{ centimeter per second per second }	cm. per sec. per sec. }

\*\*An additional unit for m.m.f. is the "ampere-turn," for flux the "line," for magnetic flux-density "maxwells per sq. in."

††The gauss is provisionally accepted for the present as the name of both the unit of field intensity and flux density, on the assumption that permeability is a simple numeric.

\*Note. The numerical values of these quantities are ohms resistance and mhos conductance between two opposite faces of a cm. cube of the material in question, but the correct names are as given, not ohms and ohm sper cm. cube as commonly stated.

‡This has been the accepted standard value for many years and was formerly considered to correspond accurately to 45° Latitude and sea level. Later researches, however, have shown that the most reliable value for 45° and sea-level is slightly different; but this does not affect the standard value given above.



# HOW TO MAKE IT



This department will award the following monthly prizes: **First Prize, \$3.00; Second Prize, \$2.00; Third Prize, \$1.00.** The purpose of this department is to stimulate experimenters towards accomplishing new things with old apparatus or old material, and for the most useful, practical and original idea submitted to the Editors of this department, a monthly series of prizes will be awarded. For the best idea submitted a prize of \$3.00 is awarded; for the second best idea a \$2.00 prize, and for the third best a prize of \$1.00. The article need not be very elaborate, and rough sketches are sufficient. We will make the mechanical drawings. Use only one side of sheet. Make sketches on separate sheets.

### FIRST PRIZE, \$3.00

#### AUTOMATIC RESISTANCE FOR "FORD" HEAD-LAMPS.

This automatic resistance was used with entire success by the author, and I thought that someone else might have use for such a wrinkle. In the illustration A is a solenoid about six inches long and two inches in diameter. A small paper tube is first made and ends fitted on, then it is wound full with No. 18 magnet wire. B is a small piece of soft iron that will fit loosely inside the tube. Some resistance wire is then secured and wound on a tube about the same length as the solenoid. F is a small upright which holds a retractile spring C. It is all mounted on a base as shown and connected as per diagram.

The action is thus: The current passing through the solenoid draws in the core, which carries a small slider making contact on the resistance wire. This action varies the current supplied to the lights on the car. When the current becomes less the spring C draws the core out and decreases the resistance and vice versa.

Contributed by H. S. OGDEN.

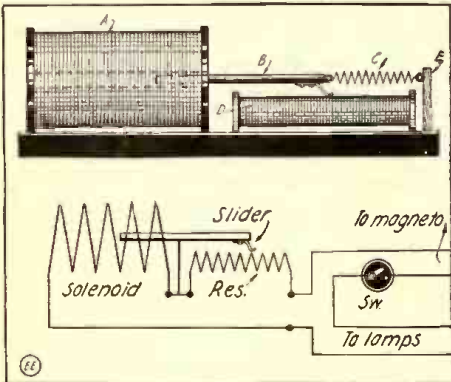

An Automatic Voltage Regulator for Ford and Other Cars. Connected in the Magneto Circuit, the Solenoid Coil "A," Acts to Pull in the Iron Bar "B" as the Voltage Increases, Thus Inserting More Resistance into the Lamp Line. The Life of the Lamps is Thereby Greatly Lengthened.

#### A LOOSE-COUPLER TUNING WRINKLE.

The question of fitting taps for couplers, which require individual turn tuning, often causes considerable trouble. If, however, taps are taken in the usual manner from each second, or each third convolution and a special coil of one, or two turns, with a separate switch, is placed on the end of primary tube, this difficulty is overcome and any possible number of turns can be used. This method will greatly decrease the number of taps, and consequently the cost.

Contributed by F. C. HAMILTON.

#### SHOP KINKS.

In drilling wrought iron or steel, always use plenty of oil. Lard oil is commonly used for such work. The oil helps to carry away the heat. When drilling or boring in cast iron, no oil is necessary. Light drilling in brass requires no oil, but

### SECOND PRIZE, \$2.00

#### A CHIME RINGER FOR THE HOME.

To a clock placed in the hall an electric chime ringer may be so connected that when

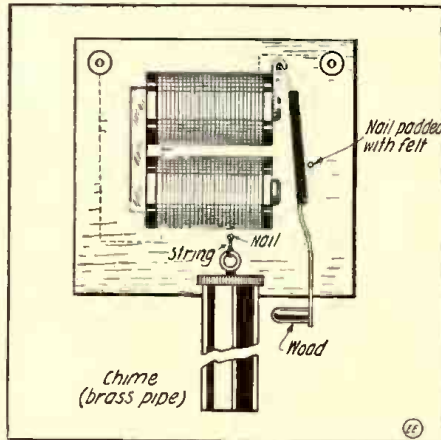

Those Who Like Electric Novelties for the Home Will Find This Chime Ringer, Actuated by the Hall Clock, a Useful and Pleasing Innovation.

the clock strikes the chime rings in a room upstairs, etc. The chime ringer is very simple to make, consisting of an ordinary vibrating electric bell, with the vibrator removed, so as to give a single stroke. The bell is also removed and chimes substituted. The clock connections are very simple and easily made. Referring to the illustration, you will note that one wire is grounded to the frame of the clock movement, while the other is connected to a very thin copper spring, which is placed just above the striker. This enables it, when raised, to strike the gong. This is a very simple but ingenious idea, and may be used with practical results.

Contributed by CLEM O. ENOS.

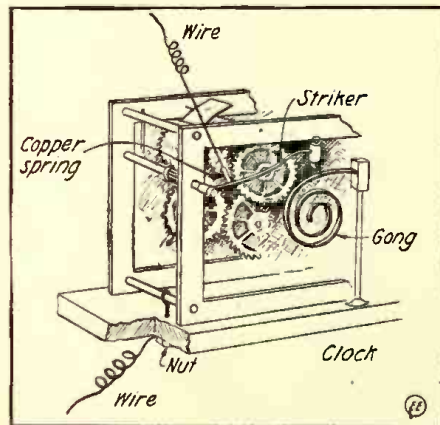

Electrical Contact Spring Arranged on Clock, so that Whenever Striker Arm Descends, It Makes Momentary Contact with Copper Spring.

fairly heavy drilling should have oil. Copper is one of the toughest materials and should receive plenty of oil. To drill large holes accurately, use a small drill first.

### THIRD PRIZE, \$1.00

#### A SIMPLE ELECTRIC BELL FOR THE EXPERIMENTER.

The base of this bell consists of a board 6" long, 3" wide and 1/2" thick. The bell A is 2 1/2 to 3" in diameter and is placed as shown. A coreless electro-magnet E, having a 1/4" hole in it, is placed in the center of the board 1" up. The plunger is made from a soft iron rod 7/32" diameter and 2" long with a 5/16" ball B secured to it. It is held in place by a spring D. The binding post P, is connected to the gong support F, with a piece of wire. The electro-magnet is connected to the binding post H and the spring D; G is a plug of soft iron about 1/4x1/4". It has three holes in it, one 1/16" in diameter, the middle, containing a piece of brass wire I; and two 3/64" holes used as vents.

Contributed by ROBERT T. CRANE.

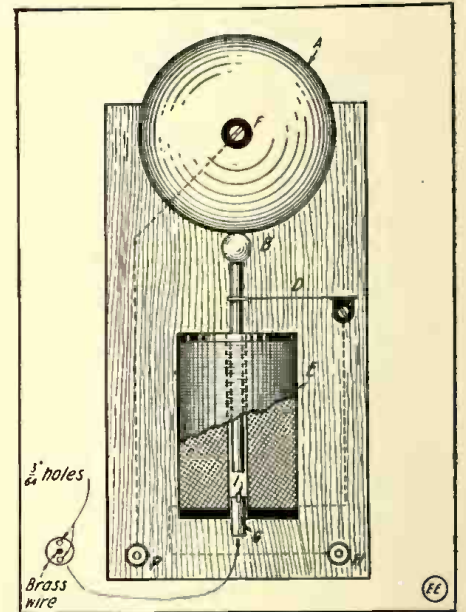

Simple Electric Bell which Can Be Easily Made by the Amateur Electrician. Silver or Platinum Contacts Will Greatly Improve It.

#### LEYDEN JAR HINT.

Following is a little wrinkle which may be useful to the readers of THE ELECTRICAL EXPERIMENTER. In constructing a Leyden jar condenser I experienced trouble in shellacking the tin-foil on the inside of the jar. Finally I placed the shellac on the glass, then rolled up the tin-foil on a stick and put it in the jar. With a little careful manipulation the foil was spread evenly around the inner face of the jar. Then a quantity of lead shot (fine shot preferable) was poured into the jar, which kept the foil prest tightly against the glass. When dry the shot was removed. Good adhesives for such work are thin shellac, banana oil, or thin glue.

Contributed by C. G. E.



**A MYSTIC MAGNETIC "BRASS" BALL.**

Here is a brass ball that is really capable of being attracted by a magnet. Impossible! you say? Well, then, take a glance at the Fig. and be convinced otherwise or, if still skeptical, try the experiment yourself. A hollow brass ball filled with iron filings and a bar or horseshoe magnet will do the trick.

All students of electricity are aware that ordinarily a magnet will not attract a brass ball. The insertion of iron filings, however, overcomes this difficulty very simply.

In view of the above the performance of this experiment will prove a puzzle to those

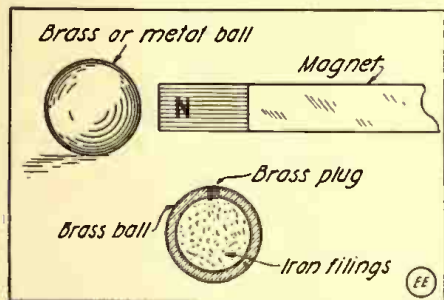

Did You Ever See a Magnet Attract a "Brass" Ball?—Then Read This Article!

"fellow-muckers" who are not in on the secret. Try it on them the next time you have the chance.

Contributed by

JOHN T. DWYER.

**A HOME-MADE DRAWER ALARM**

The materials needed are scraps of springy sheet copper or brass, some insulated wire about No. 18 for connections, two dry cells, an ordinary door bell and a few small wood screws.

From the sheet copper cut two strips  $\frac{1}{2}$ " wide and 4" long and bend these to the shape shown in Fig. 1.

Attach the two strips inside the furniture containing the drawer, and just back of the drawer, by the wood screws as shown in figure.

Adjust the hump H, of the spring A, in height so that when the drawer D, is closed it will press against H and cause the ends of A and B to separate about  $\frac{1}{4}$ ". Now when the drawer is opened even  $\frac{1}{4}$ " it will allow A to spring against B, thus closing the circuit and ringing the bell until the drawer is shut.

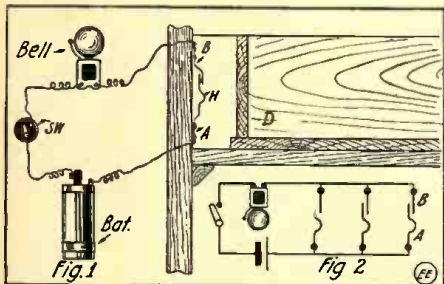

When the Drawer Is Pulled Out the Least Bit, the Switch Spring Closes and Rings the Bell.

It is well to put a switch SW in the circuit and conceal it near by so that the owner can open the drawer without actuating the alarm. Any number of drawers can be made to ring the same bell by connecting all of the A strips to one wire and all of the B strips to the other wire as shown in Fig. 2.

As none of the apparatus is on the drawer the connections are not as likely to be broken as when they depend on flexible wire.

Contributed by BRUCE McMANAMY.

**ALARM THAT RINGS WHEN DOOR OPENS.**

To make this simple but effective door alarm procure two pieces of wood, one piece  $3" \times 1" \times \frac{1}{8}"$ , and the other piece

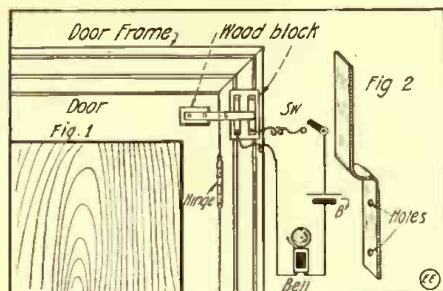

How to Rig Up a Simple Electric Bell Alarm on Your Door. Opening the Door Causes the Circuit to Be Closed.

$4" \times 1" \times \frac{1}{8}"$ . Then obtain three pieces of sheet brass or phosphor bronze, two of them to measure  $3" \times \frac{1}{4}"$  and one  $5" \times \frac{1}{4}"$ . Bend the longer strip to the shape shown in Fig. 2. Nail it upon piece of wood  $4" \times 1" \times \frac{1}{8}"$ , and screw this part of the alarm on the door, as shown in Fig. 1. Next take the other two contact strips and punch three holes in each of them as shown. Nail these upon the piece of wood  $3" \times 1" \times \frac{1}{8}"$  and screw it fast to door frame as shown in figure. Make connections as indicated. Now when the door is swung open the metal brush upon the door bears against the two fixt contacts on door frame, forming a circuit and ringing the bell. When you do not want the alarm to ring, throw off switch.

Contributed by

WILLIAM A. NICHLEERS.

**CONSTRUCTING RESISTANCE UNIT FOR SMALL MOTORS AND LAMPS.**

Herewith is a plan and description of a simple resistance to be placed in series with battery lamps, motors, spark coils, bells, etc., on the 110 volt line current.

Cut two pieces of copper, zinc or tin  $6 \times 1$  inches and solder a piece of lamp cord to each strip, long enough to reach to the apparatus to be operated and the switch.

Then take 2 pieces of fiber  $\frac{1}{4}$  inch square by 1 inch long (the crossbar of an old switch is excellent), place them between the two metal plates and bend firmly together with a few stout rubber bands.

When all is ready take a glass jar of about one pint capacity and fill it with water. Connect the two plates in series with motor or other apparatus on the 110 volt line and place the plates slowly in the water. The

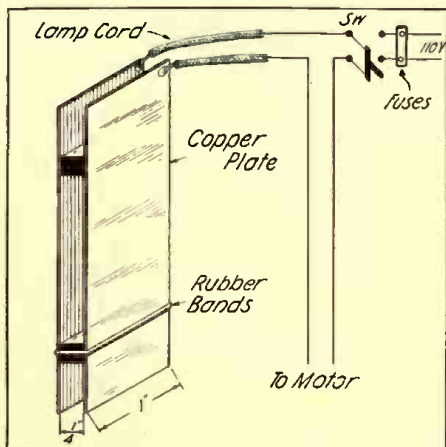

A Resistance Unit Easily Made from Two Pieces of Copper Separated by Wood Strips, the Whole Device to Be Immersed in Water.

farther down you put the plates, the more current you will get. A little salt added

to the water makes it more conductive. To make a fixt unit of this device a paste of lamp-black or powdered carbon and shellac may be placed between the plates and allowed to harden.

Contributed by

CECIL H. OSTERMEIER.

**A SIMPLE TELEPHONE RECEIVER.**

A simple telephone receiver may be made by taking an old  $\frac{1}{2}$ -lb. baking-powder can and soldering a ring made of heavy wire on the inside, about  $1 \frac{5}{16}$  inches from the bottom. The magnet can be made from a piece of round hardened steel,  $\frac{3}{8}$  inch in diameter and  $1 \frac{1}{4}$  inches long. This core is then wound with about

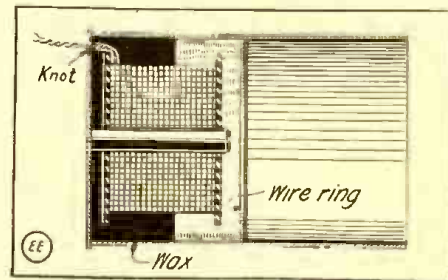

A Telephone Receiver Suitable for Experimental Telephony Is Readily Made from a Tin Can, an Electromagnet and a Tin Diaphragm.

250 feet of No. 36 insulated copper wire, the ends of which are soldered to a piece of lamp cord, passed through a hole in the bottom of the can and knotted on the inside to prevent pulling out.

A disk of thin sheet iron should be cut to the diameter of the can, taking extreme care not to bend it. The magnet is then placed in the bottom of the can in an upright position and enough melted beeswax and resin mixture poured in to hold it in place. After the wax has hardened, the disk is split in and fastened tightly by a ring of solder.

Contributed by

LLEWELLYN ABBOTT.

**DIMMING IDEA FOR "FLIVVERS"**

Fords running with lights connected in series are always in danger more or less. The device described below will enable the driver to make his way without danger.

Take a tap from the wire connecting the two head-lights together and run it to one point of a two-point switch (s); the switch-blade is connected to the magneto. The other point is connected to a resist-

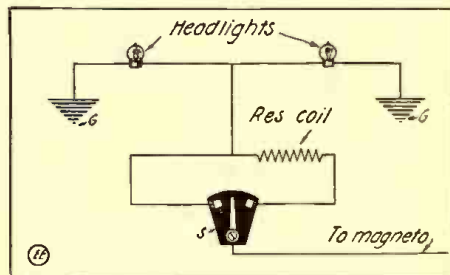

Dimming Idea for Auto Head-lights—a Resistance Coil in One Side of the Circuit Does the Trick.

ance coil for the purpose of dimming according to city regulations. The diagram shows the necessary wiring. The resistance coil may consist of a few feet of No. 20 German silver or iron wire, the proper length being found by experiment. The wire can be wound on a porcelain or wood core and suitably fastened in an inconspicuous location, as under the engine bonnet on the dash.

Note that 12-volt bulbs must be substituted in place of the regular 6-volt lamps.

Contributed by GEORGE McBETH.



# Experimental Chemistry

By Albert W. Wilsdon  
Tenth Lesson

## CARBON.

**C**ARBON exists in the free state in nature in three modifications: [1] The diamond; [2] Grafite, and [3] Amorphous Carbon.

The Diamond:—  
The diamond is a crystallized form of carbon, found in various colors, from white

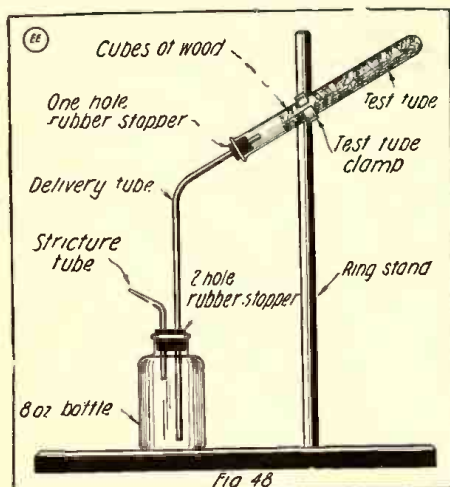

Arrangement of Test Tube Containing Cubes of Wood for Experiment in "Destructive Distillation"

to colorless, through yellow, red, orange, green, blue or brown to black. It is composed of pure carbon, and can be completely burned by fastening it with platinum in a jar of oxygen, between two poles of a battery and passing a powerful electric current over it. It is the hardest substance known, being able to scratch all other minerals, and glass.

The uses of the diamond are:

- [1] As a gem;
- [2] The powder is used for polishing others;
- [3] Larger specimens are used in mining for boring or drilling, and is known as the *Diamond Drill*;
- [4] Small fragments are set and used by glaziers for cutting glass;
- [5] They are also used by engravers for etching-points.

Grafite:—

Grafite is another crystallized form of carbon, having an iron-black to dark steel gray color, with a metallic luster. To the touch it is a soft, greasy substance. It is composed of carbon, either pure or with an admixture of iron, or occasionally of silica, alumina, and lime. Grafite is sometimes called *Black-Lead* tho there is no lead, even as an impurity in its composition.

It is used:—

- [1] For the manufacture of pencils, the hardness and softness of which depend upon the percentage of grafite used, and also upon the pressure;
- [2] As a lubricant;
- [3] As a lining for crucibles in making steel;
- [4] As a polish for gunpowder;
- [5] In the foundry to make smooth castings;
- [6] The refractory nature permits its use in crucibles for melting metals;
- [7] For the electrodes of electric furnaces.

Amorphous Carbon:—

[A] CHARCOAL:—

This is an impure variety of carbon prepared from vegetable substances or bones [Boneblack].

Wood charcoal is black, very porous, absorbs gases readily, removes color from or-

ganic liquids, and burns in the air at red heat, forming Carbon Dioxid [ $\text{CO}_2$ ]. When burned in a retort without the access of air, or in other words, by a process termed *Destructive Distillation*, the hydrocarbons, etc., are removed. During this process the compounds contained in the wood are broken up by the application of heat, and volatile gases are liberated. These gases consist of volatile hydrocarbons [which are compounds of carbon and hydrogen, and are combustible], pyroigneous acid, water vapor, carbon dioxid, etc.

It is made on a large scale by building up billets of wood into a conical heap and covering them with earth or sand. This heap is then ignited at openings near the bottom of the pile and the gases escape at small openings above.

Charcoal is used:—

- [1] For heating purposes;
- [2] As a filtering material;
- [3] As a polishing powder;
- [4] As a defactor and decolorizer of solutions and water;
- [5] As an absorber of gases and aqueous vapors;
- [6] As a constituent of gunpowder and fireworks;
- [7] As a purifier of water in filters, etc.

### EXPERIMENT NO. 35—

Arrange the apparatus as shown by Fig. 48. Fill a test tube with splinters or cubes of wood and connect the delivery tube to it by passing the tube thru a one-hole rubber stopper as shown. Set the test tube on the ring stand, at the angle shown, and pass the other end of the delivery tube thru a two-holed rubber stopper in an 8-ounce bottle. Next take a piece of glass [about 6 or 7 inches long] and first bend it as shown by Fig. 49-B, and allow to cool. After it is cold, hold the short end of the bend in the flame of a Bunsen burner [with a fish-tail attachment] until the glass softens. Then take it from the flame, and pull it so that the glass has thinned down to a very fine thread as shown by Fig. 49-C. The tube thus prepared is then filed off so that the finished stricture tube is similar to that shown by Fig. 49-D. This leaves the tube with a minute hole at the end.

After the apparatus is set up as shown, apply the heat of a Bunsen burner to the test tube containing the cubes of wood, by keeping the flame in constant motion over

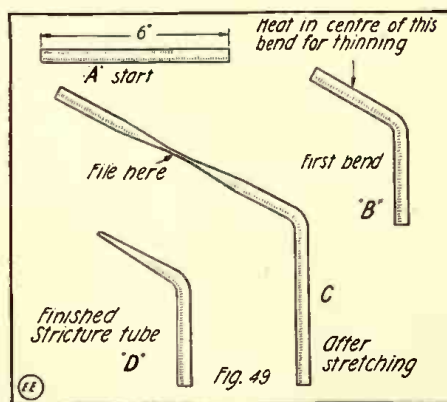

Showing Various Steps to be Followed in Making Glass Stricture Tube, for Use in Conducting Experiments Here Described.

the whole of the tube where the wood is. Never allow the flame to remain in one position as the glass of the tube will soften and finally crack.

Notice the color of the fumes passing over the delivery tube. Also the liquid in

the bottle. After the action has been going for some time, apply a light to the end of the stricture tube. What is the result?

After the action is complete, allow the apparatus to cool and examine the contents of the test tube. This substance is charcoal. How does it differ from the original wood?

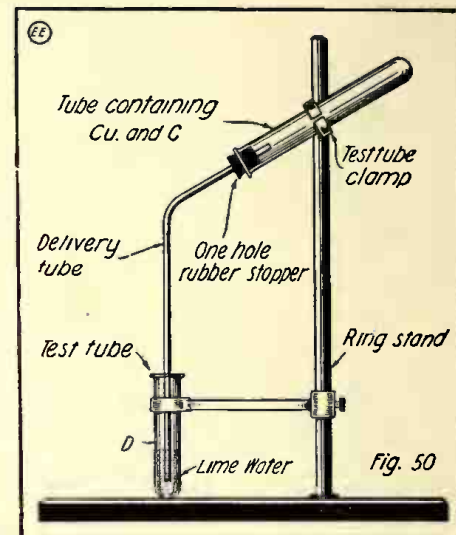

Apparatus for Experiment No. 39, the Test Tube Containing Copper Oxid ( $\text{CuO}$ ) and Powdered Charcoal (C). Gas Liberated Upon Heating the Upper Tube is Identified by Passing It Thru Lime Water.

Test the liquid in the bottle with both red and blue litmus paper. Record your results. The decomposition of material into simpler substances by means of heat is called *Destructive Distillation*. The three products obtained by the destructive distillation of wood are—a gas; a liquid; and charcoal.

Boneblack [also called Animal Charcoal]:

This is obtained in a similar manner to charcoal, namely by the destructive distillation of bones in a closed retort. In this case the volatile portions consisting of water, ammonia, etc., are driven off and the finely divided carbon is disseminated thru the porous calcium phosphat left behind. It has the power of absorbing gases, removing the coloring matter and alkaloids, etc., from their solutions.

It is used:—

- [1] To decolorize organic substances and especially in the refinement of sugar.
- [2] It has also been used to disinfect ulcers, etc.

### EXPERIMENT NO. 36—

With a new set of apparatus the same as used in the foregoing experiment, and in place of the wood fill the test tube with animal bones. Heat as before, and record your results. Test the gas at the end of the stricture tube by applying a flame. What were the results? After the heating is complete, and the apparatus cooled, examine the substance which remains in the test tube. Apply all of the foregoing tests and compare the results with those of the foregoing experiment.

Lampblack:—

Lampblack is practically pure carbon, and is nothing more than pure soot, such as can be readily seen when a kerosene lamp smokes. It is a velvety, jet-black powder very finely divided, and shows no traces of crystallization. It is formed by igniting various oils, which are mostly hydrocarbons, and collecting the unburned carbon or smoke.

(Continued on page 859)



# Wrinkles Recipes Formulas

EDITED BY S. GERNSBACK

Under this heading we publish every month useful information in Mechanics, Electricity and Chemistry. We shall be pleased, of course, to have our readers send us any recipes, formulas, wrinkles, new ideas, etc., useful to the experimenter, which will be duly paid for, upon publication, if acceptable.

## EXPERIMENTER'S APHORISMS

In the following, we wish to give to the experimenter some hints as to the use of the different ingredients and how to work them:

- (1) Always bear in mind that exact working of a formula requires ACCURACY, CLEANLINESS, PATIENCE, and SKILL.
- (2) Know what you are about, before you start to experiment.
- (3) "THE HISTORY OF FAILURES IS THE HISTORY OF SUCCESS" goes an old adage, and it applies well to the experimenter.
- (4) Many times impure, wrong or deteriorated raw materials, spell FAILURE instead of SUCCESS.
- (5) A great many of the chemicals and ingredients required, cannot be obtained from drug stores; buy them at a reputable supply house.
- (6) BEFORE CONDEMNING A FORMULA, be sure the fault does not lie with the manner of handling it, or the purity of the ingredients.
- (7) Be sure to mix the materials comprising a certain formula in the proper sequence.
- (8) When starting to prepare a mixture, especially one containing liquids, ask yourself: "IS THE SPECIFIC GRAVITY CORRECT, AS INDICATED BY A HYDROMETER? IS THE TEMPERATURE RIGHT? IS THE QUANTITY OR WEIGHT RIGHT?"
- (9) Acids and water, when mixed, should be manipulated in the proper manner, i. e., THE ACID SHOULD BE POURED INTO THE WATER, and not vice versa, as the solution is liable to be forcibly ejected from the containing vessel and into the mixer's face.
- (10) For any kind of SYSTEMATIC WORK, a floating THERMOMETER and HYDROMETER, as well as measuring glasses and scales, should always be provided, as GUESS-WORK is EXPENSIVE, and SOMETIMES FATAL.
- (11) Put labels on ALL bottles, boxes and packages with FULL INSCRIPTION as to their contents. It will avoid troubles and mistakes.
- (12) Remember that a beginner cannot expect to make articles AT FIRST, which will compare with regular manufactured products. S.G.

## A MAGIC FIRE FLUID.

The magician appears with a small bottle of colorless liquid in one hand and a few pieces of white paper in the other. He proceeds to pour a little of the fluid on the paper and then places the paper on a screen or some other metal support.

Then he steps back; in the meantime explaining to the audience that this magic fluid, invented by the Japanese thousands of years ago, was used by them to torture their prisoners, or relating any similar story to keep the audience interested. In a few minutes, usually about two, the paper will burst into flame spontaneously. The trick is very mystifying to any one who does not understand the principles involved.

However, it is really very simple. The fluid is prepared by dissolving phosphorous in carbon di-sulfid. Be extremely careful in handling the phosphorous, to cut it under water and not to touch it with your hands. Also keep the carbon di-sulfid away from open flames, as it is very inflammable. The odor of the commercial product is rather disagreeable, but this may incidentally add to the mystery of the trick.

What really happens is this: The phosphorous is dissolved in the carbon di-sulfid. When poured on the paper the carbon di-sulfid evaporates, leaving the phosphorous impregnated in the paper (in a finely divided form). This starts to oxidize and soon raises the temperature of some part of the paper to the kindling point.

Practically any kind of paper will do for this trick. Filter and newspaper both work well. The main thing is not to spill it on anything that you do not wish to burn as it works 100 per cent of the time.

Contributed by

GEORGE W. GREENE.

## ELECTRIC GLASS JAR CUTTER

Procure two brass or iron rods, 7" long by 1/4" diameter. Flatten them out slightly at both ends and drill holes, just large enough to pass a battery bolt, 1/4" from the ends as shown. Notice that at one end the rods are flattened for about 3/4" so that they can be almost closed. The rods are fastened together at A with a battery bolt and two nuts. A third nut serves to hold the wire lead. The arms should work smoothly. Battery bolts are inserted at B and C and a piece of German Silver or other resistance wire, connected at B, forms a loop and in turn is connected at C. The length of wire and size remains with the experimenter, depending upon the current available. No. 22 German Silver wire will suffice for use on a step down transformer of about 8 volts.

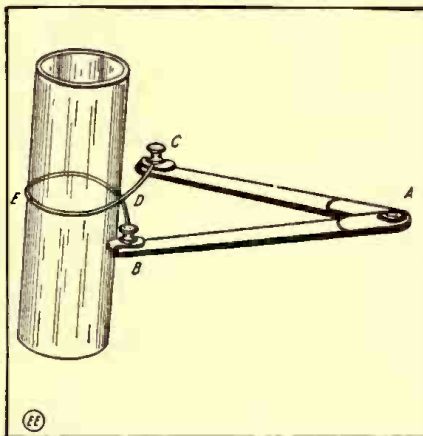

An Electric Glass Tube and Jar Cutter—Current is Past from "E" to "A". Heating Wire, when Glass is Wetted at the Point where Wire Encircled It.

To cut a glass jar, grip the instrument in the right hand with the two fingers between the two arms so that they can be spread further apart if necessary. The loop of wire is placed around the jar at the point at which it is to be cut and held taut. One lead from the source of current is connected at A and the other is held in the left hand and touched at point E on the wire for a few seconds. For best results the wire should almost reach a red heat. After being left in place for a few seconds dash a little cold water against the heated glass. A clean break should result.

Contributed by W. P. RATHERT.

## MISCELLANEOUS FORMULAE

**To Poison Rats.**—Mix together 2 ozs. of carbonat of barytes with 1 oz. of lard and lay it in their way. Also put a dish of water near, as it causes great thirst and as soon as they drink they die instantly.

**To Preserve Dead Pts.**—One lb. of dry sulfate of aluminum, one-fifth of a quart of water and twenty grains of arsenous acid, well mixed. Inject this into all the vessels of the body and you can thus preserve cats, dogs, birds, fish, etc.

**Trick Cigarette Papers.**—Take common cigarette papers and dip them into a solution of saltpeter and water; be sure they are thoroughly impregnated, then lay them out to dry. When they are dry replace them in their original package and hand them to a friend. He will receive the surprise of his life.

**Fulminating Powder.**—Mix together in a warm mortar one part of saltpeter, two parts sulfur. Place on the edge of a fire shovel and hold over the fire. It will turn black and explode with a loud report.

Contributed by

JOHN D. COLEMAN.

## INK RECIPES.

**Everlasting Black.**—Tannic acid, 1 oz.; crystal gallic acid, 77 grs.; sulfate of iron, 5 drs.; gum arabic, 100 grs.; dilute muriatic acid, 1/2 oz.; Carboic acid and water (acid 10 drs.; water, 1 1/4 pints). Mix the acid and water and dissolve the other ingredients therein. This ink will not fade.

**Red Ink (Bright).**—Dissolve 25 parts of saffron in 500 parts of warm glycerin, then stir carefully in 500 parts of alcohol and 500 parts acetic acid. It is then diluted with 9,000 parts of water, to which a little gum arabic may be added.

**Gold Ink.**—Fine bronze powder is mixed with a little sulfate of potash and water; the precipitate is mixed with water and a sufficient amount of gum

**Green Ink.**—Rub 3 drs. of Prussian blue and 6 drs. gamboge with 4 ozs. mucilage and a pint of water.

**Silver Ink.**—Silver leaf ground with a little sulfate of potash is washed from the salt and mixed with water and a small amount of gum acacia.

**White Ink.**—Triturate together one part honey and two parts of dry ammonia alum. Dry thoroly and calcine in a shallow dish over a fire until perfectly white. Cool, wash, rub up with sufficient gum and add water for use as ink.

**Vanishing Ink.**—This ink consists of an aqueous solution of iodide of starch. Characters written with it completely vanish in about four weeks.

**Cement (Acid Proof).**—Asbestos, 2 parts; sulfate of barium, 3 parts; silicate of sodium, 2 parts. Mix thoroly and the result will be a cement for all purposes that will resist the strongest acids.

**Diamonds (Imitation).**—White sand, 900 parts; red lead, 600 parts; pearl ash, 450 parts; niter, 300 parts; arsenic, 50 parts; manganese, one-half part. Melt and pour into cold water. To make it harder use less lead and if it has a yellow tint use more manganese.

Contributed by

RICHARD GAILLARD.

## HOW TO MAKE ALLOYS.

**For Clichés or Printing Plates.**—Tin, 48 parts; lead, 32.5 parts; bismuth, 10.5 parts; antimony, 9 parts.

**For Candlesticks, Spoons, Vessels.**—Tin, 80 parts; lead, 20 parts.

**For Imitation Silverware.**—Tin, 92 parts; lead, 8 parts.

**For Pieces of Jewelry; or Substitute for Silver.**—Tin, 80 parts; antimony, 20 parts.

**For Fusible Metal.**—Bismuth, 50 parts; lead, 30 parts; tin, 20 parts

**Brass for Medals.**—Copper, 95 parts; tin, 4 parts; zinc, 1 part.

**Brass for Cymbals and Kettledrums.**—Copper, 80 parts; tin, 20 parts.

**Brass for Bells.**—Copper, 77 parts; tin, 23 parts.

**Substitute for Gold.**—Copper, 94 parts; antimony, 6 parts; magnesium carbonat, 1/3 part.

Contributed by

AGUSTIN GALVAN (Mexico).



# WITH THE AMATEURS

Our Amateur Radio Station Contest is open to all readers, whether subscribers or not. The photos are judged for best arrangement and efficiency of the apparatus. To increase the interest of this department we make it a rule not to publish photos of stations unaccompanied by that of the owner. Dark photos preferred to light toned ones. We pay each month \$3.00 prize for the best photo. Make your description brief and use only one side of the sheet. Address the Editor, "With the Amateurs" Dept.

## AMATEUR RADIO STATION CONTEST.

Monthly Prize, \$3.00.

*This month's prize-winner.*

### A NEW HAMPSHIRE AMATEUR RADIO WORKER.

I present herewith two photos of my wireless station that I would like to enter in your Amateur Radio Station contest.

Harry L. Dearborn, Who Has Built His Own Radio Apparatus and Aerial Masts. His Set Brings in Stations from Duluth to Key West, at Lincoln, N. H.



The aerial that I now have is 102 feet high and about 250 feet long, composed of two No. 12 copper wires, with a diagonal lead-in of about 100 feet. I use this aerial mostly for receiving.

The set shown consists of two inductive tuners, one of which has a slider and is used for waves up to 3,000 meters; the other has switches on both primary and secondary and is used for short waves up to about 1,500 meters. A loading coil is used and so connected that it can be switched into either primary circuit. Three Murdock variable condensers are used, two of which are of .001 mf., and a small one of .0005 mf., which is connected across the 'phones. A simple galena detector is also used. On the wall over the tuners there is seen a double bulb Audion detector; switches are provided to throw the secondary on either the galena or Audion detector.

Above the Audion detector is a variometer that I sometimes use in place of a loader, and the small coil shown is connected to load up the secondary circuit when using the Audion.

I use a pair of Murdock 3,000 ohm 'phones and just above the 'phones is a 15 plate omnigraph that I use when in need of practise.

The transmitting set I now have includes only a 1" coil, gap and key, and I don't very often use it as my aerial is too big for it.

Every bit of the instruments shown with the exception of the 'phones and condensers

were built by myself, including all brass work, studs, knobs, etc., and during the past two years I have built a number of sets, mostly cabinets. The set shown in the July issue by Mr. Hunt was built by yours truly also the panel he now has. Am a member of the *Radio League of America* and N.A.W.A.

I am situated in the heart of the White Mountains, hence the high aerial and have had very good success so far, my limit being Key West, Fla. (south), and Duluth, Minn. (west). Have also built a few Audion amplifiers with good success. All my instruments are insulated entirely with hard rubber; not a connection touches wood.

The aerial poles are built up in sections: of doubled 2" by 4's, bolted together, and each section averages about 16 feet in length. I had to put the poles up alone which was not such a lard job as it looks to be. Eight sets of guy wires—three wires to a set—hold it perfectly steady.

HARRY L. DEARBORN.

Lincoln, N.H.

### WIRELESS SET OF GEORGES C. DELAGE.

The transmitter to the right of the change-over switch in the accompanying photograph consists of a  $\frac{1}{4}$  K.W. Clapp-Eastham set on which I have mounted a rotary gap (upper cabinet) and an oscillation transformer, key and motor switch to left of change-over switch.

The receiving (left to right) consists of a large, home-made loading coil, 2 galena

Efficient Wireless Station Owned by Georges C. Delage, of Greenwich, Conn. He Hears the Key West, Colon and Darien Stations.



detectors, detector switch, short-circuiting switch, Mesco variable condenser, E. I. Co., fixt 'phone condenser, Clapp-Eastham loose coupler, Amco variable condenser, buzzer key and 3,000 ohm Holtzer-Cabot 'phones.

There are two aerials, one being 250 feet long, two wires, 5 feet apart and 90 feet high, for receiving only. The other is 85 feet long, 3 wires, 3 feet apart, 80 feet

Has your station photo appeared in "The Electrical Experimenter"? Why not purchase the electrotype and have some "real" stationery printed with your station picture on it? All of the "regular radio-bugs" are doing it.

high, made of stranded phosphor bronze wire.

I have worked distances of over 30 miles and have heard Key West, Colon, Darien and Miami. My call is 1VW.

GEORGES C. DELAGE.

Greenwich, Conn.

### RADIO "LAB." OF ANDREW L. SHAFER.

My receiving set consists of a 2,500 meter loose coupler, loading coil, Audiotron cabinet (not shown in photograph), galena and Crystaloi detectors, variable condenser shunted across the secondary of the coupler, fixt condensers, Brandes' 'phones and the usual buzzer test. By means of a S.P. S.T. switch, I can connect the loading coil into the primary circuit and it is then possible to receive wave lengths of about 4,000 meters. When using the galena detector I hear NAA very loud; NAA, NAJ, WHK, WCN, WOR, VBB, VBE, and a host of other land, boat and amateur stations. Of course the Audiotron brings in countless others.

For transmitting I use a one-inch spark coil, oscillation transformer, fixt and quenched spark gaps (as alternates), glass plate condenser immersed in castor oil and a heavy key. The current for operating the set is supplied by a 6 V. 60 A.H. storage battery.

I have communicated with 8 NH of St. Marys, Ohio, several times, the distance being thirty-four miles air line. I have worked with 9 WF of Fort Wayne, Ind., once, a distance of thirty-four miles also. 8 NH reported once, "sigs good. You sound like a  $\frac{1}{4}$  K.W." I attribute this good work mainly to natural conditions as there are no hills or large forests to interfere.

My aerial is of the 4 wire, inverted "L" type, 75 feet long, with a spacing of 3 feet, between each wire, supported by two masts 51 feet and 60 feet high, respectively. A very good ground connection is secured thru a copper boiler and an iron plate 2 feet square, each buried 6 feet in damp earth and an iron pipe rammed into the ground 10 feet, all being connected with No. 4 stranded copper cable.

I hold a second grade amateur license and my official call is 8 TE. I should be



Andrew L. Shafer "Listening In" at His Radio Receiving and Transmitting Station Located at Scott, Ohio. He Works Stations 34 Miles Away on a One-inch Spark Coil, Excited by Storage Battery.

very glad to have any one visit my station or to call me by radio.

ANDREW L. SHAFER.

Scott, Ohio.



**NEW INTERNATIONAL RADIO LIST.**

The Berne bureau has announced the completion of the fourth edition of the Liste Alphabetique des Indicatifs D'Appel (Alphabetical List of Call Letters) of the radio stations of the world.

This publication may be procured from the Director, International Bureau of the Telegraph Union, Radiotelegraphic Service, Berne, Switzerland, at the price of 1 franc 30 centimes per copy, plus 35 centimes postage. Remittances should be made by international postal money orders.

**RADIO SET OF C. M. PEARSON.**

My wireless set is a very simple one, composed of a loose coupler, loading coil, galena detector, fixt condenser and a pair of 2,000 ohm receivers. All are of my own construction, except the condenser and phones.

The highest point on the aerial is 42 feet, and the ground is made to a spike driven

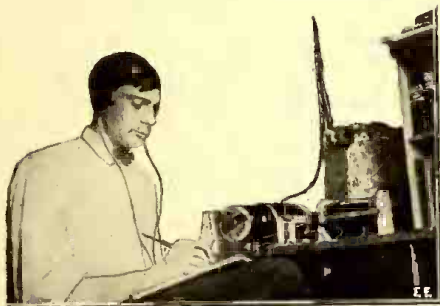

C. M. Pearson Enjoys His Radio Set, Hearing Arlington (NAA) Daily.

into a tree, the pump and some other miscellaneous earthed metal rods.

I hear Arlington (NAA) every night and can also hear their time signals at noon each day.

C. M. PEARSON.

Upland, Ind.

**UNCLE SAM TO AID AMATEUR WIRELESS OPERATORS.**

For the encouragement of local students of wireless telegraphy, Ensign Philip F. Hambsch of the Albany Navy recruiting station recently announced the willingness of the Navy Department to assist the amateurs in their studies. The purpose of the department's order is said to be for the purpose of educating operators for use in time of war.

The local recruiting station will take steps toward assisting the local wireless organizations.

**UKELELE MUSIC BY RADIO.**

The following dialogue actually took place between two naval men and was related to ye editors by one who overheard the conversation:

Radio Operator (on a torpedo boat lying off the Carolina coast): "Good morning, Captain; just picked up 'Koko Head.' Some class to our set, what?"

Commanding Officer: "Go 'way with that stuff. Next you'll be telling me you hear the Ukeleles playing in Honolulu!"

**ASKS \$400,000 FOR PORTO RICO RADIO.**

Secretary Daniels has asked Congress to appropriate \$400,000 for a high power wireless station in Porto Rico.

Mr. Daniels said the island is of "extreme strategic importance, in connection with the fleet operations, due to its loca-

**KEITH McKELLIP, A RADIO STAR OF THE WEST.**

I have an aerial 70 feet long and 30 feet high. The receiving outfit includes a 3,500



Keith McKellip, a Youthful Radio Enthusiast of Des Moines, Iowa.

meter loose coupler, two crystal detectors, a pair of 2,000 ohm Brandes' 'phones, a fixt condenser and a loading coil.

The sending apparatus comprises a 1/2 inch coil, a nine-plate condenser, an E. I. Co., spark gap, key and a tuning helix.

I have obtained very good results with this set. I have no license call yet but expect to have one before the season is over.

KEITH McKELLIP.

Des Moines, Iowa.

tion, and with a protected high power wireless station communication would be insured with the fleet, with Europe and with South America, to a greater degree than by any other means."

**Amateur News**

**The Suburban Radio Club of Washington, D.C.**

The Suburban Radio Club of Washington, D.C., is holding a large membership campaign by which it hopes to enroll practically every amateur wireless operator in the District of Columbia and vicinity as a member.

The club is making a big effort to dispense with all unnecessary interference this coming spring and will try and impress every amateur with the importance of causing as little interference as possible.

The organization possesses several valuable instruments which are at the disposal of every member. Every amateur in Washington should make it a point to get in touch with the Secretary, Chas. Longfellow, Jr., for further information. Address 5515 Potomac Avenue, N.W., Washington, D.C. The Secretary would be pleased to hear from other Radio Clubs in the United States as to their activities.

**The Louisville Radio Club, Louisville, Ky.**

During the week of the Kentucky State Fair held at Louisville, some time ago, The Louisville Radio Club was given space in their booth by a local newspaper and a I K. W. station was erected. NAA and several other high-powered radio stations were readily heard, while many amateur stations were "worked," much to the delight and interest of the bystanders, and especially to the young ladies who, when they began asking questions, kept those in charge "some" busy.

The exhibit netted the club six new members and prospects of a number of several other members. The Louisville Radio Club has been in existence since March 1916, and now has a membership of about 45, who own and operate stations ranging from a simple 1-inch spark coil set, up to a 1 k.w. rotary gap outfit with a supersensitive receiving set.

The meetings are held on the 1st and 3rd Thursday of each month. Certain members are assigned to read papers and sometimes the meetings are given a social aspect by the two club comedians, I. P. Bohan, Club Reporter, 1410 Stock Building, Louisville, Ky.

**The Nassau Radio League, Freeport, L.I.**

A short time ago a meeting of radio amateurs of Freeport and Merrick was called by the or-

ganizers, Thomas F. O'Brien and Sinclair Raynor at the headquarters, 8 North Main St., Freeport, L.I., N.Y.

The following were elected to hold office until September 11, 1917:—

President, Thomas F. O'Brien, Vice-President, Stephen Carpenter; Secretary, Holmes Swezey and Treasurer, John McCord.

The club affairs are in the hands of an executive committee composed of the officers and three lay members (Clifton Weindek, Stanley Terry and Wilbur Verity) with the President acting as Chairman of the meetings. Chief Operator, Bertram T. Donnelly; 1st Assistant, Sinclair Raynor and 2nd Assistant, Ilberman Betz.

Business meetings are held the first Friday in each month. Code practice and lectures are given the second, third and fourth Friday in each month. The Tel-Radion Company of New York presented the club with a Detector. Correspondence is solicited. Address the Secretary at the Club Wireless Station, 8 N. Main St., Freeport, L.I., N.Y.

**The Experimenter's Radio Association.**

The Experimenters' Radio Association of Pittsburgh, Pa., completed a very successful term ending August 29, 1916. The election at the opening of the new quarter placed the following in office:—Ernest A. Munch, President; George Chartener, Secretary, and Paul Schmidt, Treasurer. At the end of the first quarter the club purchased an Electron Relay bulb from the receipts of the previous three months. THE ELECTRICAL EXPERIMENTER, as well as other scientific

journals, are kept in the Association Library for the use of the members.

The initiation fee is twenty-five cents, and a fee of ten cents must be paid every week as dues. In return for the above, the members receive weekly lectures, books on Radio Telegraphy and Telephony, etc., as well as the use of the instruments of the Club. For application blank or further information, address Corresponding Secretary, Albert A. Munch, 105 Excelsior St., Pittsburgh, Pa.

**San Francisco Radio Club Making Rapid Progress.**

The membership of the San Francisco Radio Club, the only large radio organization in that city, has increased so rapidly that it became necessary to vacate the former club room at 737 Shrader St. and occupy a new large and modern meeting hall at 350 Frederick St., north-east corner of Belvedere St.

The new club room is amply large enough to accommodate 100 persons, and without a doubt the membership will reach the hundred mark by the end of the year. Due to the enormous amount of correspondence to be carried on by the secretary, Mr. H. R. Lee, an assistant Secretary has been elected, Mr. E. W. Radford being the successful candidate.

Plans for the installation of a modern radio station are under way and within due course of time the club room will be equipt with one of the best radio stations in the city.

The club is steadily growing in popularity and an average of ten new members are admitted monthly.

The first edition of the Year Book of the San Francisco Radio Club has been sent to hundreds of addresses; available copies still on hand may be procured from the Secretary, a two-cent stamp to be added in order to lighten the burdensome mailing charges.

Among prominent radio operators recently admitted to the club are Mr. H. R. Spradde of the National Wireless Telephone Co., Mr. F. L. Busch, Radio operator at the Fort Winfield Scott station, and several former marine operators of the Marconi Co.

Meetings are still held as usual, Friday evenings at 8 P.M. Notices and announcements as well as application blanks may be secured from the Secretary, H. R. Lee, 1580 Grove St., San Francisco, Cal.

**RADIO CLUBS ATTENTION!**

We are always pleased to hear from young Edisons and Radio Clubs. Send a write-up of your Club with photos of members and apparatus to-day to: Editor "Amateur News" Section, The Electrical Experimenter, 233 Fulton St., New York City.



OFFICIAL LIST LICENSED RADIO AMATEURS NOT TO APPEAR UNTIL NEXT ANNUAL GOVERNMENT CALL BOOK. Amateur Radio Stations Licensed by the Bureau of Navigation During the Month of July, 1916. (Continued)

Table with columns for Call signal, Owner of station, Location of station, Power kilowatts, and Call signal, Owner of station, Location of station, Power kilowatts. Includes sub-sections for FIRST DISTRICT, SIXTH DISTRICT--(Cont'd.), SEVENTH DISTRICT, and EIGHTH DISTRICT.

Amateur Radio Stations Licensed by the Bureau of Navigation During the Month of August, 1916.

Table with columns for Call signal, Owner of station, Location of station, Power kilowatts, and Call signal, Owner of station, Location of station, Power kilowatts. Includes sub-sections for FIRST DISTRICT, THIRD DISTRICT--(Cont'd.), FOURTH DISTRICT, and FIFTH DISTRICT.

(To be Continued)



**ELECTRICITY AND LIFE.**

*(Continued from page 798)*

Some years ago the great Swedish scientist, Arrhenius, was reported to have subjected one-half of a class of school children to the action of high-frequency currents, one hour daily for several months, at the end of which time there was marked increase in the average growth, weight, general health and mental ability in the electrified pupils as compared with those not so treated. At the present time high-frequency currents are actually being used in truck-gardens to promote the growth and increase the size of vegetables for table use.

The high-frequency currents, in short, act as *vitality boosters*—no other form of electricity will do this. *Galvanism, Faradism, Static* electricity are all valuable agents in the hands of the Electro-therapeutic specialist, but they have little direct action in promoting cell vitality and growth, as do the high-frequency currents when properly applied.

Authorities explain the action of high-frequency currents in various ways, the favorite theory being that the healing effect is due solely to the liberation of heat in the tissues. It is perfectly true that in many diseases the heat liberated in the body by the passage of from 400 to 2,500 milliamperes at a frequency of about one million cycles is an important agent in promoting an artificial inflammatory reaction and increasing circulation. The heat is, however, only one of the *secondary* forces generated by the current; there are many other factors in the vitalizing effect. The thermic theory will, for example, not explain the increased growth of plants produced by the action of high-frequency currents of very high voltage and low amperage. In medical practise often the most marked results are obtained by the use of Tesla currents of low intensity, but of exceedingly high potentiality. The author can account for these effects only on the theory that these currents, when of proper frequency, are *synchronous with the normal rate of sympathetic nerve vibration*, and in this way increase the flow of the mysterious *Pranic* force thru which function and tissue growth are maintained.

High-frequency currents are now extensively used by the medical profession to increase cell growth, metabolism and functional activity. They tend to normalize the blood pressure and are the only agents that are of real curative value in certain stages of Arterio-sclerosis (hardening of the arteries). They greatly augment the defensive powers of the organism, enabling it to resist and overcome disease-producing agencies. The prejudice against high-frequency currents on the part of many physicians may be attributed to the fact that they do not employ proper technique or that they use an apparatus which does not admit of proper variation of frequency, amperage and voltage, in order to suit the requirements of the individual case.

In the next article the author will describe the details of construction of an apparatus suitable for the generation of high-frequency currents for therapeutic use and the technique for their application.

**AN ELECTRIC "MOVIE" MACHINE FOR THE HOME.**

*(Continued from page 795)*

The mother may catch on the film the first steps of the toddling baby; the boy can snap his mates at play; the family can have their birthday motion pictures of every member, not to mention the Thanksgiving and Christmas reunions.

The adoption of this instrument to the study of various subjects will be of immeasurable value, especially in geography, biology, chemistry and physics, which will

certainly be simplified by the use of this invention. The new device may be used with equal advantage for projecting visualized bulletins for public use. It is without doubt one of the greatest inventions in the motion picture field and will certainly solve many dubious problems.

**20,000 LEAGUES UNDER THE SEA.**

*(Continued from page 791)*

force, it is also fitted with a torpedo, which is later actually discharged at one of Capt. Nemo's enemies.

Our second photograph illustrates the submarine's sea drop-door open, one of the sailors emerging under the water. The crew, when starting on its undersea journey, is equip with the necessary diving apparatus, these being self-contained and employing no lines or pipes with which to supply fresh air. On the back of the sailors are strapped compressed air tanks and these are carried about without undue trouble. The divers' feet are covered with shoes having heavy leaden soles so as to increase the body weight, permitting the operator to walk on the bottom of the sea.

We see several wonderful actual scenes at the bottom of the ocean and one of our illustrations shows a photograph of the crew of the *Nautilus* walking on the sea bottom entirely free from any encumbering connections whatsoever. One of the sailors can be seen holding a sea turtle which he is carrying in his hand, clearly shown in our illustration.

Considerable difficulties are encountered in walking on the ocean bottom, due first to the tremendous water pressure and second to swift currents along various points. Many interesting underwater performances are given by Capt. Nemo and his crew; the scenes showing actual man-eating sharks and hunting them, is perhaps one of the most thrilling pictures ever made. There is no faking in these pictures and in one of them can be actually seen how one of the sharks makes a vicious slash at Capt. Nemo, only to be rebuffed with the butt of his rifle. Another fascinating scene is that showing a battle with an octopus with Capt. Nemo, but this scene was obviously staged with a dummy octopus. Another scientific feature shown, which, by the way, was predicted by Jules Verne, is the employment of compressed air guns which are quite necessary for the undersea hunts.

What the audience of course does not see is how these pictures were taken. It involved the use of wonderful electrical equipment in producing this most remarkable film. To begin with, a special camera had to be employed. This was enclosed in wide tubes fitted with powerful lenses at the lower end. Into this tube was placed a regular photographic motion picture camera as well as the person operating it. While many of the pictures were taken in actual sunlight (the sun shining directly thru the water and giving sufficient illumination, providing the depth was not too great), most pictures were taken at such a

depth that electrical illumination was necessary. This was accomplished by projecting powerful beams from electrical searchlights on the scenes to be filmed. The electrical energy supplying these monstrous electric arcs was fed thru heavy submarine cables and attached to dynamos driven by gasoline engines, supported on barges near the scene of this Twentieth Century Capt. Nemo's exploits.

As an educational film, "20,000 Leagues Under the Sea" probably rivals anything that has appeared heretofore.

It is a great pity that Jules Verne, who died some eight years ago, could not have lived to see this wonderful picture, which so well demonstrated his vast knowledge in all the various branches of science.

*Photos Courtesy of Universal Film Company*

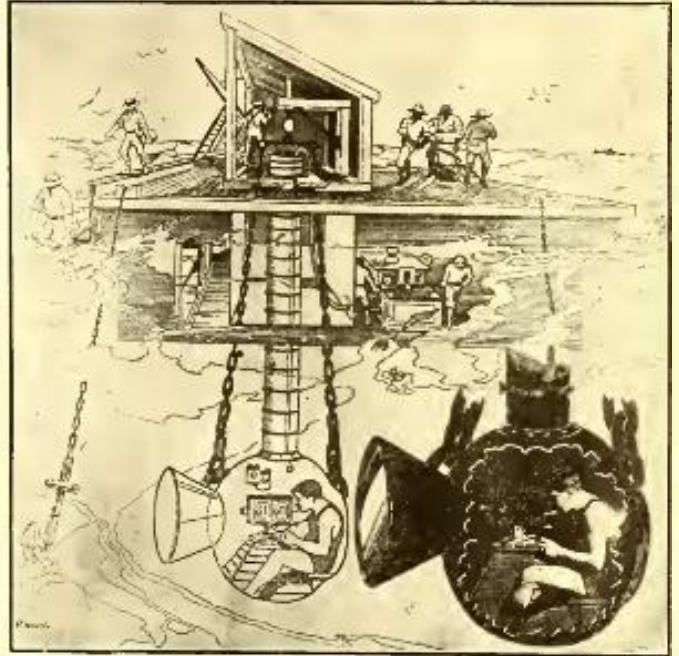

Illustrating the Novel Manner in which Scenes for the "20,000 Leagues Under the Sea" Movie Spectacle Were Photographed by Placing the Camera and Operator (In Swimming Suit) Down in a Special Tube.

**FUR COAT "ELECTRICITY" BLOWS UP AUTO.**

Electricity induced by the friction of a fur coat worn by Surgeon Raymond Spear, U.S.N., grounded thru an automobile standing on wet ground and caused a spark which exploded the gasoline, burning Surgeon Spear severely and destroying the machine. The surgeon was able to leave the naval hospital here, but still is under treatment at his home.

Surgeon Spear had walked some distance to his garage in his fur coat and rubber boots. The friction of the flapping of the coat against his legs generated the electricity, while his boots insulated him from the ground and allowed his body to store it. A spark did the rest.

**CELEBRATING MR. EDISON'S BIRTHDAY.**

The employes and associates of Mr. Thomas A. Edison celebrated his seventieth birthday at a dinner held in the electric storage battery building, West Orange, N.J., at 6:30 p. m., Saturday, February 10. The event was informal and entirely social, and about 1,500 persons were present. Some of Mr. Edison's personal friends and former associates were invited. Mr. Edison's birthday is really on February 11, but on account of that day falling on Sunday, it was decided to hold the celebration on Saturday the tenth.



# LATEST PATENTS

### Advertising Novelty

(No. 1,207,945; issued to John Jay Lepper.)

A unique electrical advertising attraction comprising a transparent cigar-shaped body; upon this are mounted a figure (Indian) holding a cigar and a figure representing Satan. An electric motor within the base drives a worm wheel, which latter causes the Satan figure to

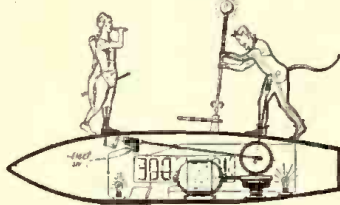

bend forward, the spear descending and the lamp atop it lighting up, as well as the lamps within the transparent base. The mechanism also causes the Indian to place the small cigar in proximity to his mouth. The electric current may be supplied from battery or lighting circuit. The name of dealer can be placed on side of transparent base, being thus periodically illuminated.

### Electrical Connector

(No. 1,209,604; issued to Hosea F. Maxim.)

An extremely simple and cheaply manufactured form of electrical connector, suitable for attachment to dry cells and other electrical apparatus.

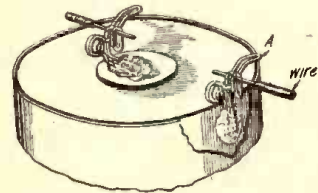

It combines, in its design, extreme simplicity, being formed from a single piece of springy wire, which requires no other operations but that of bending.

The connector may be soldered to dry cell electrodes and the conductor is secured therein by pressing down on the extending finger, A.

A number of novel modifications in the design of this connector are given in the patent. The connector is to be made of some springy wire, such as phosphor bronze, brass or steel.

### Thermionic Amplifier

(No. 1,210,678; issued to Alexander McLean Nicolson.)

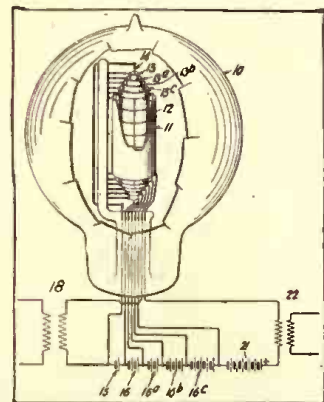

In the figure, 10 represents a highly evacuated vessel; 11 an anode; 12 an input electrode;

13 equipotential cathode; 14 auxiliary cathode or filament. Cathode 14 of platinum, coated with oxides, and heated by battery 15 emits electrons, which bombard cathode 13, maintained positive by battery 16. Cathode 13 is made thermionically active also. A number of equipotential cathodes can thus be used, having successively increasing electron-emitting properties. Each of the cathodes 13, 13a, 13b, and 13c, receives a bombardment; batteries 16, 16a, 16b and 16c maintaining each succeeding cathode positive with respect to the preceding cathode.

### Improved Primary Cell

(No. 1,201,709; issued to Charles Féry.)

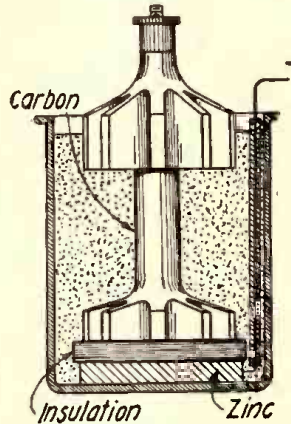

Over the zinc is placed a sheet of insulation such as felt, or hard rubber, etc. On this insulation rests the carbon element as shown. By thus keeping the zinc at the bottom of the jar the ammonium gas can be liberated freely and without encountering the chlorid of zinc, with which it combines in the ordinary cell of this type, to form crystals which mitigate against the efficiency of the battery.

The cell rapidly depolarizes due to the considerable electric currents which are generated between the top and the bottom of the carbon electrode.

### Relay for Undulatory Current

(No. 1,212,163; issued to Eric Magnus Campbell Tigerstedt.)

An improved relay for undulatory currents which may be actuated by a microphone O, and the effect noted in a telephone receiver H, connected thru an induction coil. FG.

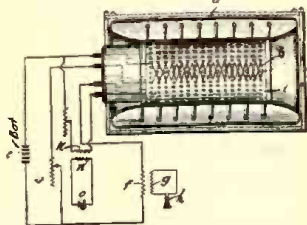

The relay comprises a soft iron cylinder, containing an evacuated chamber A. Therein reposes a cathode B, in the form of a helically wound wire, supplied with battery current so as to become heated. A helical anode is placed over the perforated grate-shaped auxiliary electrode, I.

By this design, the ionizing rays, owing to their radial movements, will be the least affected by external magnetic and electrical influences.

The current variations in the primary winding N, graduated by mic-

rophone O, are transmitted to the secondary K, and auxiliary electrode I, so that the resistance between the latter and the cathode is thereby altered. This changes the resistance of the discharging tube, which causes the microphone fluctuations to be transmitted to the primary F, of the telephone receiver circuit and, eventually, to the receiver H.

### Surgical Cleansing Apparatus

(No. 1,209,846; issued to Charles Edmund Kells.)

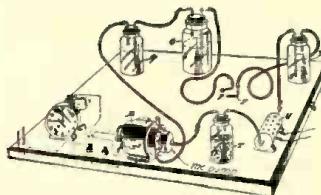

In this electrical surgical cleansing and medicating apparatus, an electric motor drives a vacuum pump, the motor being operated at certain periodical, definite intervals.

An electric heater U, is placed in the tube thru which the medicating or relief vapors pass; T, being a filter; O, the catch receptacle for pus or other fluids brought from the wound, and Q is the wash jar. V is the ether jar and FF, the tips to be placed in the wound.

### High Frequency Radio Circuit

(No. 1,211,863; issued to David G. McCaa.)

This arrangement is adapted to radio-telegraphy and radio-telephony. A large condenser, having about fifteen times the capacity of the one across the secondary, is con-

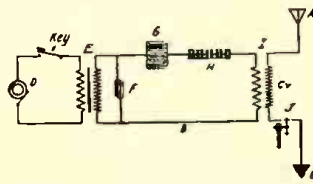

nected in series with the spark gaps and the primary of an air-core transformer.

This method consists in electrically energizing an oscillatory circuit, charging the opposite poles of the condenser F, by conduction, simultaneously charging the opposite poles of large condenser G, by conduction and induction, discharging said condenser G, across the multiple spark H, and controlling such condenser discharge at the gap.

### Apparatus for Producing Vibratory Motion

(No. 1,207,387; issued to Reginald A. Fessenden.)

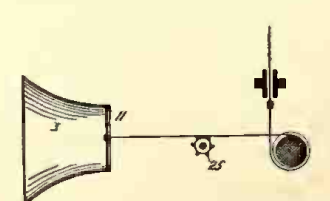
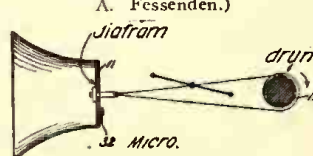

A method of producing powerful

sound waves or vibrations by causing a steel ribbon or wire to oscillate a diafram; the steel ribbon, taking a turn about a phosphor bronze wheel or drum.

When the phosphor bronze wheel is rotated so as to render one end of the steel band tight and the other end loose, the wheel acts as a rotating snubbing block and pulls the diafram in a certain direction, which causes the opposite end of the steel wire or band to slacken to such an extent, that the turns on the wheel 13 slip, causing the diafram to return to its normal position; after which the operation is again repeated.

### Ultra-Violet Ray Generator

(No. 1,207,347; issued to Joseph Von Kowalski-Wierusz.)

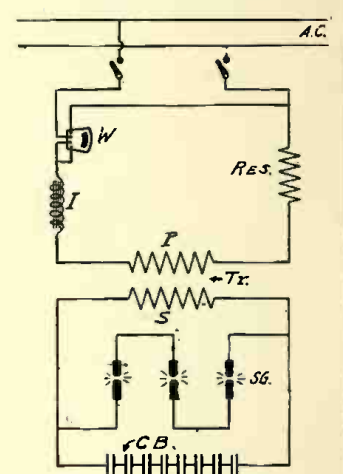

A source of alternating current supplies a step-up transformer, the secondary circuit of the step-up resonance transformer containing the special arc SG, and condensation battery CB, of the proper size.

### Apparatus for Submarine Signaling

(No. 1,207,388; issued to Reginald A. Fessenden.)

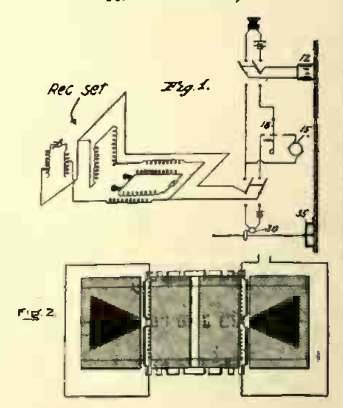

Energy from an alternating current dynamo 15 passes into an electro-magnetic sound producing mechanism (vibrator) 12, Fig. 2.

A key 16, may break up the powerful sounds produced by 12, mounted on the steel hull of a ship so as to radiate telegraphic dots and dashes. The sound waves striking the hull of the vessel from a distant station may be interpreted thru the same mechanism 12, or thru a vibrating reed and microphone, 20-35.

A microphone and source of current may be used to excite oscillator 12, when sending telephone speech thru water.

COPIES OF ANY OF THE ABOVE PATENTS SUPPLIED AT 10c. EACH



# Phoney Patents

Under this heading are published electrical or mechanical ideas which our clever inventors, for reasons best known to themselves, have as yet not patented. We furthermore call attention to our celebrated Phoney Patent Offizz for the relief of all suffering daffy inventors in this country as well as for the entire universe.

We are revolutionizing the Patent business and OFFER YOU THREE DOLLARS (\$3.00) FOR THE BEST PATENT. If you take your Phoney Patent to Washington, they charge you \$20.00 for the initial fee and

then you haven't a smell of the Patent yet. After they have allowed the Patent, you must pay another \$20.00 as a final fee. That's \$40.00!! WE PAY YOU \$3.00 and grant you a Phoney Patent in the bargain, so you save \$43.00!! When sending in your Phoney Patent application, be sure that it is as daffy as a lovesick bat. The daffier, the better. Simple sketches and a short description will help our staff of Phoney Patent examiners to issue a Phoney Patent on your invention in a jiffy.

## PHONEY PATENT OFFIZZ

S. M. ARTALEK of KOKOBUST, O.  
AUTO PARASITE

### Spessification of Patent Bettors

cars—not only will work at no cost to its owner, but it will actually charge his storage battery free of charge as well.

Referring to my drawing A is a dynamo drove by the hindmost axle of the flivver. As soon as the hindmost wheels rotate, the dynamo by virtue of its inherited powers begins to charge without charge the storage battery B. From this latter aforementioned and thusly described battery B, two electric conductor insulated wires lead to a double electromagnet C of generous and stoutish proportions as will be observed and seen by looking at the aforementioned above previously pointed out

### Patent Magnified

mentioned electromagnet C is energized most powerfully and simultaneously shoots out on the *now extended* aforementioned X: :X: :X. Inasmuch as most car bodies are of sheet tin, the electromagnet will experience a strong affinity for the car ahead and consequently will hang on with bulldog tenacity, incidentally pulling along the flivver, owner, all aforementioned above, at least as long until t'he wealthy guy ahead gets wise. In that case a new victim must be secured.

### WHAT I CLAIM IS:

1° A gasless, costless, juiceless flivver attachment.

No.  $\sqrt{\frac{E.M.F.}{S.O.S. \frac{1}{4}}}$

### TO HUME IT RIGHT CONSERVES:—

Let it be known to all in and out habitants of the Universe and Uniprose, as well as to all subjects of possessions and territories, not admitted to Planetdom, that I, S. M. Artalek of the City of Kokobust in the State of Complete Ossification, have conceived, devised, invented and finally think out an exceedingly efficient as well as profissient means of Flivver-propulsion, which to the best of my knowledge and widespread researches has not appeared before in print anywhere in the Universe.

Inasmuch as gasoline prices have been rising skyward with such alarming regu-

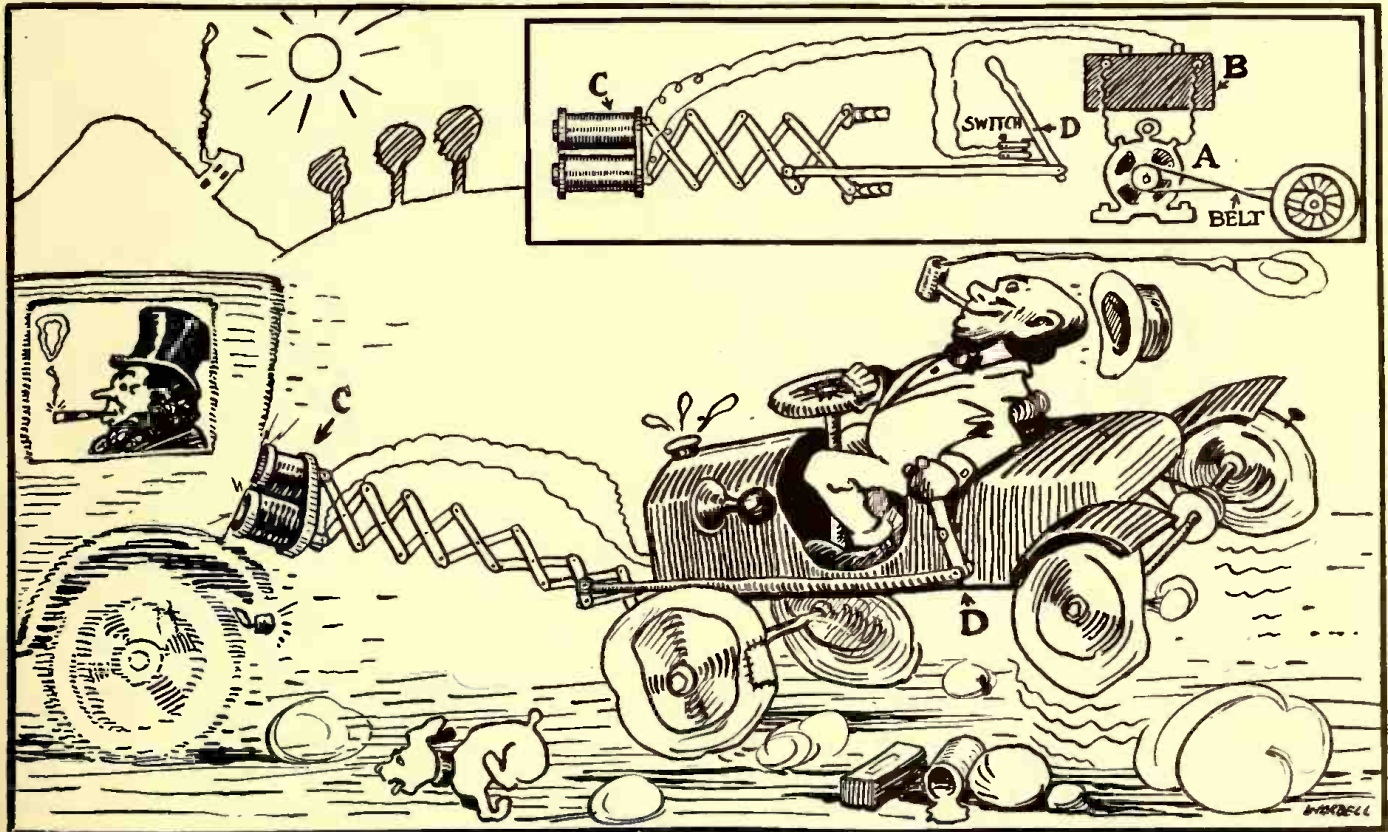

" . . . I Have Devised a Very Simple Electro-magnetic Auto Propulsion Apparatus, which can be Installed at Low Cost on Any Flivver . . . Once Installed, This Device—the 'Auto-parasite'—Not Only Will Work At No Cost to Its Owner, but Will Actually Charge His Storage Battery Free of Charge."

larity of late, it has become a manifest impossibility for ordinary cattle to run about in Runabouts or Runallivers. Altho enterprising garages are now giving away a completely equipt flivver with every five-gallon can of gasolene, the owners have no further use for the car, after the original supply of gas gives out, as a second mortgage on the house and cow will not bring sufficient cash to buy enough gas to prime a spark plug. Realizing this lamenting state of affairs, I have devised a very simple apparatus which can be installed at low cost on any flivver, completely and successfully taking the place of gasoline. Once installed, this device—which I term Auto-Parasite, because it lives on wealthy men's

drawing forming part of this patent spessification.

Now then, the electromagnet C aforementioned above and described thereunder is mounted at the bow-most end of a movable X:X:X:X:X as best seen and visualized as well as observed in aforementioned described drawing.

At the stern-most end at the starboard side of the movable X:X:X:X:X also aforementioned and duly described, a lever arrangement D with a handle is organized, planted and otherwise attached to suit the erstwhile fancy of aforementioned flivver owner described and pointed out above. By moving aforementioned lever D forward at the critical moment, the afore-

2° An autoparasitic attachment prying upon the body of rich men's cars.

3° An automatic gratis-working autopuller for the masses.

In memoriam whereof, I have thus heretofore imprest in hard wax, seal in hand, my pussyfooted phizt this 19th day of our Ford, 1917,  $\frac{1}{8}$  of 12 O'Clock Moon, with 63° humidity on the 78 meridian due East.

S. M. ARTALEK,

By His Attorney,

JAMES McLAUGHLIN MONO,

Fair Haven, N.J.

### WITNESSES

C. Laret

Al. Kohol,

W. H. Yskey.



# QUESTION BOX

This department is for the sole benefit of all electrical experimenters. Questions will be answered here for the benefit of all, but only matter of sufficient interest will be published. Rules under which questions will be answered:

1. Only three questions can be submitted to be answered.
2. Only one side of sheet to be written on; matter must be typewritten or else written in ink, no penciled matter considered.
3. Sketches, diagrams, etc., must be on separate sheets. Questions address to this department cannot be answered by mail free of charge.
4. If a quick answer is desired by mail, a nominal charge of 25 cents is made for each question. If the questions entail considerable research work or intricate calculations a special rate will be charged. Correspondents will be informed as to the fee before such questions are answered.

## RESISTANCE OF RHEOSTAT.

(712-A.) F. Eilman, St. Louis, Mo., asks:

Q. 1. How is the resistance of a rheostat varied?

A. 1. The conductors are generally all in series and connections are made at various points with contact buttons, upon which a moving arm sweeps, so as to include more or less of the resistance. Sometimes the resistance is reduced while the carrying capacity is increased by putting more or less resistance units in multiple, as when a bank of incandescent lamps is used for regulating a current. Combinations of the two are made occasionally, the highest resistance being given by connecting the units in series while the resistance is reduced by cutting out one section after another, the resistance being still further reduced by putting units in multiple.

Q. 2. What is the difference between a pole-changer and a pole-changing transmitter?

A. 2. The construction of a pole-changer is such that the circuit is momentarily broken at each reversal, whereas in the pole-changing transmitter, continuity of the circuit is preserved.

Q. 3. What is accomplished by the use of relays on telegraph lines?

A. 3. They reduce considerably the battery current required and the size of conductors used. The relays operate on a small fraction of an ampere while telegraph sounders require a fairly large current in amperes. The relay for main line work is usually of 150 ohms resistance; short line relays have 20 ohms resistance, and specially wound sounders of 20 ohms resistance are sometimes used. Relays are of more delicate construction and consequently more sensitive than sounders, which latter utilize a heavy sounding bar. The sound given off by a relay armature is often intensified by fitting a resonator or diaphragm horn to it, as described some time ago in this journal.

## X-RAY QUERIES.

(712.) Paul Higgins, Charleston, S.C., wishes to know:

Q. 1. How are X-rays produced?

A. 1. If an electrical discharge be passed thru a vacuum tube, X-rays are produced whenever the cathodic stream is arrested by the walls of the tube or metallic objects therein.

Q. 2. What is a focus tube and for what kind of work is it most applicable?

A. 2. A focus tube is one in which a concave cathode electrode causes the stream of electrons to be focused upon a flat target or anode. They are generally used for obtaining a rapid radiograph of finite, concentrated area.

Q. 3. What is the composition of chemicals employed in the manufacture of fluorescent screens?

A. 3. They are generally composed of platinum-barium-cyanid, while the cheaper variety are made with phosphorescent calcium sulfid.

## BELL CIRCUIT.

(713.) I. Simpson, Ottawa, Canada, inquires:

Q. 1. What precaution should be taken with a bell when continuously operated?

A. 1. The contacts should be cleaned regularly and also adjusted as required.

Q. 2. Can you give me a wiring diagram of a 4 bell and 4 drop annunciator for a fire alarm?

A. 2. The diagram herewith gives the proper connections.

Q. 3. What is the appearance of an arc when observed thru a smoked glass?

A. 3. The current (or rather the incandescent carbon particles) is plainly seen passing from the positive to the negative carbon.

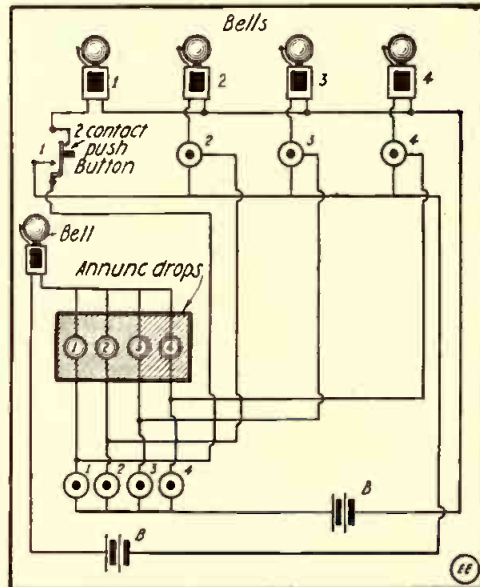

Wiring Diagram for Four Room Bells and Four Drop Annunciator, so that Clerk Can Ring Guests' Bells in Case of Fire.

## PUPINIZATION.

(714.) W. Wilson, Pittsburgh, Pa., asks:

Q. 1. What is meant by Pupinization?

A. 1. The word is derived from Professor M. I. Pupin, of Columbia University, who introduced the first successful method of loading telephone cables and aerial lines. The inductance coils are built in ring form and each has a definite value, depending upon the characteristics of the line and its location.

When working with telephone cables, certain obstacles are to be overcome, such as inductance, capacity, resistance and leakage. Capacity troubles telephone engineers most, and this was compensated for by adding inductance to the line. Special care is exercised in designing inductance (loading) coils, and Professor Pupin was the one who developed mathematical proofs and design data of loaded telephone cables.

The attenuation of cables is very important; it is wise to keep this as low as possible. The American Telephone and Telegraph Company consider 3.66 for the attenuation constant of a cable. This constant is obtained from a large expression.

However, this was reduced to a simpler one:

$$B = \sqrt{\pi f C R}$$

Where:

B=attenuation constant for the cable.

f=frequency.

C=capacity.

R=resistance.

It was Pupin who formulated the different values of B. We would especially refer you to THE ELECTRICAL EXPERIMENTER for August, 1916, page 274—"Question Box."

Q. 2. In what unit is leakage expressed?

A. 2. This term has not as yet been empirically nomenclatured, but it is expressed as the reciprocal of insulation resistance, which is in megohms and is called mohms. It is very small in aerial telephonic lines and quite large in underground cables.

## HIGH FREQUENCY RESISTANCE.

(715.) John Olsen, Hempstead, L.I., inquires:

Q. 1. Is the direct current resistance of a conductor equal to that offered by the same conductor, when said wire is excited by means of an oscillatory high frequency current?

A. 1. The high frequency resistance of a conductor, when it is excited, is not the same as its D.C. resistance, but is several times as great as its D.C. resistance. The following expression is used for calculating the high frequency conductor size:

The high frequency resistance of the conductor is:

$$R^1 = R \frac{\pi d}{80 \sqrt{N}}$$

Where:

R<sup>1</sup>=high frequency resistance of the conductor.

d=diameter of conductor in centimeters.

R=direct current resistance of conductor.

N=frequency of the oscillatory current passing thru the wire.

The formula below applies only to solid, nearly straight or slightly curved, circular-sectioned copper wires.

Where:

$$d = .4774 \sqrt{\frac{P}{N}}$$

d=dia. wire in cms. for high frequency current.

P=resistivity of the conductor (=1600 for copper).

N=frequency.

Q. 2. Does the Cohen circuit of capacity tuning prove more efficient than the straight inductance tuning?

A. 2. The capacity tuning of the Cohen circuit is more selective than the straight inductance system, but it has been found that it is not particularly efficient when it is used on wave lengths above 2,500 meters, and on long distance work.

Q. 3. Does it effect any improvement to employ several arcs for radiophone work and are they better than a single arc?

A. 3. Several arcs are better than a single arc, as considerably more current is generated with a multiple arc system. The

(Continued on page 836)



# READ THESE LETTERS

## HERE IT IS—AND HERE IS WHAT IT DOES



**"PARAGON" RA-6 Amplifying Short Wave Receiver.**  
Range 180-580 meters. Price \$35.00.

*"It Has Solved the Transcontinental Relay Problem"*

*"Improve It and It Is Useless"*

No tuning capacities, and no switches in the Audion Circuits.

No end losses, and no short circuited turns.

Amplifications up to 100 times.

Selectivity as great comparatively as the amplification.

All amplifications obtained without change of spark tone.

Covered by a 2-year satisfaction-or-your-money-back guarantee.

FURTHERMORE, we guarantee the RA-6 to so far excel other short-wave receivers, that there is no comparison.

### A PRODUCT MAY BE JUDGED BY ITS USERS!

"The results obtained have been almost marvelous."  
(2LK) J. O. Smith, Valley Stream, N. Y.

"In a word, I think it is the greatest short wave tuner I ever saw."  
(8JZ) Rev. A. J. Manning, Cleveland, O.

"I take this time to congratulate you on the design of the perfect short-wave receiver. I have never seen anything in its class before."  
(2FS) Howard L. Stanley, Babylon, N. Y.

"I am delighted with the results."  
(2AFT) Folger Oudin, Schenectady, N. Y.

"I like the RA-6 very much."  
(1ZM) Hiram Percy Maxim, Hartford, Conn.

"The results obtained with it have surprised me very much. Using it I worked 2AGJ at Albany for about an hour, and not once did he fade out so I could not get him back. At times I could hear him several feet from the 'fones. Other stations hitherto just readable come in very loud."  
(9IK) R. H. G. Mathews, Chicago, Ill.

"Results entirely satisfactory. Atmospheric conditions not at all good. Notwithstanding this, however, with two sets of 'fones in series, we could hear and copy many long distance stations including 5DU, 5AM, 8AEZ and 9BY as well as several others we did not mark down."  
John C. Cooper, Jr., Jacksonville, Fla.

"The Set' received several days ago. I want to say it is a peach, and even surpassed my expectations. It is a wonder for selectivity, and all signals very much louder. Have heard stations that I had never heard before, and worked 1VN at noon. You may remember that Hartford has always been closed to us around here."  
(2AGJ) John K. Hewitt, Jr., Albany, N. Y.

"Never dreamed that the possibilities of this type of apparatus were so great until I installed instrument."  
Wm. H. Allison, Worcester, Mass.

"The finest set for amateurs I have ever tried out. Just as you represented it to me. Have been able to hear some 5s, some 4s, and any number of 1, 2, 3, 8, and 9 stations every night, no matter what the air conditions."  
(2ZP) John W. Hubbard, Port Chester, N. Y.

"Have used the RA-6 for about a week with such marked results, that thought a word of appreciation at this time might be of interest to you."  
(2IM) L. Spangenberg, Lakeview, N. J.

"The increase in intensity of signals received is almost beyond belief, and I have astonished many of my friends, as well as myself. The set is the most selective I have ever handled, and when familiar with it wonders may be performed."  
(2ABG) C. R. Runyon, Jr., Yonkers, N. Y.

### PARAGON INSTRUMENTS HAVE SET NEW STANDARDS

Send stamp today for Bulletin O. It will interest you. It describes a variety of correctly designed apparatus—apparatus which is unequalled.

**Send 6c. for our 232 pp. Catalog**

---

*Our No. 7 Catalog shows several hundred different parts and also sets of materials for building your own apparatus. We do all the difficult work in our factory and give you the benefit of machinery and equipment.*

*Contains complete description and prices of all the latest Wireless and Electrical Goods.*

---

OUR PRICES WILL SAVE YOU MONEY AND OUR PROMPT DELIVERIES WILL SAVE YOU TIME

**THE BEST CATALOG OF ITS KIND IN AMERICA**

**Adams-Morgan Co.,** <sup>13</sup> Alvin Place **Upper Montclair, N. J.**



# Send 10c for Our Manual of Wireless Telegraphy W9

You Get Your Money Back on an Order of \$1.00

It contains 180 pages and tells how to erect and maintain wireless telegraph stations. Shows a number of diagrams. Has the Morse and Continental Telegraph Codes. Illustrates the best instruments to use; tells what they are for and how to use them. Has many new diagrams and other valuable information not contained in any other book. Do not wait. Send your request now. Get the best 10c value you will ever buy.



Send your request now. Get the best 10c value you will ever buy.

# Send for Our New Catalog W28

It is pocket size, contains 248 pages, with over 1,000 illustrations and describes in plain, clear language all about Bells, Push Buttons, Batteries, Telephone and Telegraph Material, Electric Toys, Burglar and Fire Alarm Contrivances, Electric Call Bells, Electric Alarm Clocks, Medical Batteries, Motor Boat Horns, Electrically Heated Apparatus, Battery Connectors, Switches, Battery Gauges, Wireless Telegraph Instruments, Ignition Supplies, etc.

IT MEANS MONEY SAVED TO YOU to have our Manual and our Catalog when you want to buy.

## Manhattan Electrical Supply Co., Inc.

New York: 17 Park Place Chicago: 114 S. 5th Ave. St. Louis: 1106 Pine St.  
San Francisco Office: 604 Mission St.



## SPARK COILS For Wireless

STYLE C SPECIAL 1" COIL \$3.50  
Postage extra

FINE RESULTS WITH THIS COIL  
SCHUG ELECTRIC MFG. CO.  
254 EAST LARNED, DETROIT, MICH.

Learn Watchwork, Jewelrywork and Engraving. A fine trade commanding a good salary, and your services are always in demand. Address HOROLOGICAL Department, Bradley Institute, Peoria, Ill., for our latest catalog

### QUESTION BOX.

(Continued from page 834)

only difficulty encountered in operating a multiple arc is in properly adjusting them for an oscillating condition.

#### MAGNETIC ORE SEPARATOR.

(716.) P. Pierpont, Hoboken, N.J., wants to know:

Q. 1. How does Edison concentrate iron ore magnetically?

A. 1. The ore treated is a magnetic ore of iron held in about three times its weight of easily crushed rock. This is crushed between rollers and then allowed to fall in a thin sheet in front of a series of magnets, which deflect the iron particles, but allow the iron magnetic rock to fall vertically. A thin, knife-edged partition board separates the two falling streams. The attracted particles are dried and ground and then separated again from the rock material, then treated chemically and again separated.

Q. 2. How is the attraction of unlike poles and the repulsion of like poles explained?

A. 2. There is no complete explanation agreed upon, altho all the actions can be referred to simple laws. There is tension along the lines of force and a pressure at right angles to them.

#### SELENIUM CELLS.

(717.) Frank Heeney, Portland, Ore., asks:—

Q. 1. How are selenium cells made?

A. 1. The subject on the construction of selenium cells is quite extensive, and limited space forbids us to publish here complete details on their construction. We refer you to the November 1915 and September 1916 issues of THE ELECTRICAL EXPERIMENTER in which you will find a complete exposition of the construction of selenium cells. If you have not these copies available, we can furnish them postpaid at fifteen cents each.

Q. 2. Is it practical to employ such cells in the construction of a talking moving picture machine?

A. 2. As far as we are informed, tests on such devices have been fairly successful, but we have not heard much lately regarding the further development of such apparatus. The subject is a very interesting one and there is, we believe, a possibility of such a device being developed for commercial use. So far as we know there has been but one extensive article ever published on the use of selenium in talking motion pictures, which appeared in the June, 1915, issue of THE ELECTRICAL EXPERIMENTER, which we can supply you for twenty-five cents, if you have not this issue on hand.

Q. 3. Will you kindly inform me as to the originator of selenium cells in talking motion pictures.

A. 3. This dates back to 1904 when Ernest Ruhmer, the German physicist, developed a workable model of such a machine.

#### USING LARGE SPARK COIL FOR WIRELESS.

(718.) C. Murray, Winnipeg, Man., Canada, asks several questions regarding a 12-inch spark, specially built induction coil.

A. 1. We believe that you use a primary condenser much too large; i.e., made up of 7-2 mfd. condensers connected in parallel. Your spark coil appears to be heavy enough to qualify as an open core A.C. transformer, and you should be able to satisfactorily operate it from the usual A.C. circuit, with a suitable rheostat; or, better an adjustable iron core impedance in series with it to control the current. It also should work very well with an electrolytic  
(Continued on opposite page)

### THUNDERSTORMS OF THE UNITED STATES.

A thoro study of the distribution of thunderstorms has been made by Mr. W. H. Alexander with the aid of the officials in charge of more than one hundred of the regular weather bureau stations. Following this, Professor R. DeC. Ward has fittingly brought out the significance of the thunderstorm as a climatic phenomenon, says Science.

Thunderstorms are produced (1) by the excessive heating of the lower air; (2) by the over- and under-running of winds of different temperatures, which in some way cause moist air masses to rise rapidly; and (3) by the cooling of the upper air. These causes usually are not individually responsible for any thunderstorm; but act in conjunction. Excessive heating of the lower air occurs in summer and most favorably on plains, plateaus and intermont basins.

Thus in the United States the maximum number of thunderstorms is to be expected in the Mississippi Valley, and in the western mountain and plateau region. Furthermore, most come in summer: in 126 of 139 stations considered the month with most thunderstorms is June, July or August. Cyclonic activity in a region subject to marked temperature changes is usually responsible for the production of thunderstorms by over-running and under-running winds. This leads to the winter and spring thunderstorms; particularly in the southern Mississippi Valley where the lower air is warmest and dampest. The cooling of the upper air while the lower remains relatively warm is characteristic of a marine location. With the aid of cyclones, thunderstorms produced in this way are to be expected in winter and at night. The Pacific coast region thus tends to have its thunderstorms, few at most, in winter.

For illustration, the accompanying table shows the monthly percentage frequencies of days with thunderstorms at seven stations in the United States. A thunderstorm day is now defined as one on which thunder is heard whether or not rain falls at the observing station.

Station	Per Cents. of Ten-year Total Occuring in Each Month												Total Thunderstorms, 1904-1913
	Jan.	Feb.	Mar.	Apr.	May	June	July	Aug.	Sept.	Oct.	Nov.	Dec.	
San Francisco, Cal.	12	50	12	0	0	0	0	0	12	0	13	8	
Fresno, Cal.	3	14	16	14	16	5	3	0	11	8	5	5	37
Boston, Mass.	2	1	4	4	14	17	23	22	11	2	2	1	180
New York, N. Y.	1	1	3	9	14	18	25	19	9	3	0	0	284
Chicago, Ill.	2	1	6	8	15	16	17	16	12	4	2	0	400
Santa Fe, N. Mex.	0	1	3	4	9	15	29	24	12	3	0	0	732
Tampa, Fla.	1	2	3	3	10	17	24	22	14	3	0	1	944

At San Francisco, atmospheric instability does not often occur in summer. Fresno has its maximum early probably because the air is too dry in mid-summer. The other stations have the greatest number in summer. Boston, New York and Chicago all have an abundance of moisture. The greater number of thunderstorms in Chicago for the year, and particularly in spring, as compared with New York and Boston, is due to its continental position and exposure to rapid temperature changes. The interior location favors more rapid warming in spring than is the case in the east. Even New York appears markedly more continental than Boston. It is noteworthy that there are more thunderstorms in May than in September; May is moister; and the upper air is colder. The great thunderstorm activity at Santa Fé is favored by the mountain location (altitude 7,013 feet) east of the Rio Grande. In June, July and  
(Continued on page 840)



**QUESTION BOX.**  
(Continued from page 836)

interrupter and a choke coil in series to regulate the current. When it is used in this way on 110 volt A.C. circuit, a kick-back preventer of an approved pattern, should be connected directly across the primary terminals of the coil and thoroly grounded.

This coil should give you good results for wireless purposes and we should imagine that it would give you in the neighborhood of 1/2 to 3/4 k.w. depending upon the regulation of the current in the primary circuit. You will find a great deal of valuable information in this direction in our excellent twenty-five cent handbook entitled "How to Make Wireless Sending Apparatus."

**BOOK QUERY.**

(719.) The T—M—Co., Muscatine, Iowa, asks for information on books:

A. 1. We refer you to our *Book Catalog* in which you will find a number of excellent books listed on high frequency apparatus, induction coils, etc.

We can supply a copy of the book entitled "The Design and Construction of Induction Coils" by A. F. Collins at \$3.15 prepaid. We can also supply you with the book "Induction Coils, Their Theory, Design and Construction," by H. Armagnat for \$2.10 prepaid. An excellent work on Liquid Air by Sloane, which covers the making of snowballs, etc., artificially, is worth \$2.00.

**LOCATING BURIED GOLD AND SILVER DEPOSITS.**

(720.) Geo. H. Gibson, St. Louis, Mo., writes:

Q. 1. Can you advise me of an electrical apparatus that will accurately locate gold and silver deposits in the ground?

A. 1. We do not know of any device which will intercept and interpret or make manifest the extremely minute electrical radiations, if such they are, sent out by the vibrations of the atoms in chemicals such as gold or silver buried in the ground.

Some success has been claimed in locating such metallic deposits if they are not buried too deeply with the Hughes' induction balance, which was described on page 260 of the August, 1916, issue of THE ELECTRICAL EXPERIMENTER, a copy of which can be obtained at 15 cents.

**RADIATION FROM WIRELESS STATION.**

(721.) L. A. G., Los Angeles, Cal., writes us concerning his radio station and the theoretical efficiency of the same as computed by the usual formulae.

A. 1. The reasoning and formulae as set forth in Mr. Whitney's article in the November, 1916, issue of THE ELECTRICAL EXPERIMENTER, are correct. There was a small discrepancy made in carrying out the computations incident to working the formula as mentioned on page 671, December issue, but the formula itself and the terms therein are correct.

You will find this method explained in all of the radio handbooks, including those by Dr. J. A. Fleming and Dr. Eccles.

The editor of this column has had some experience with this radiation current formula and the terms therein vary of course for different designs of aerial. It is found that for your case, and considering the natural or fundamental wave length of your inverted "L" antenna squared as 5,700,000, the radiation in watts would be 24.8 and the net efficiency of the station 24.8 divided by 1,350 watts input or 1.84 net efficiency, which is nearly 2 per cent.

The different quantities here involved are not very explicitly stated in your letter and the low efficiency in either case might be

(Continued on page 840)

**THIS FAMOUS ELECTRO-SET CO.'S  
HANDY BOOK AND CATALOGUE**

**FREE**

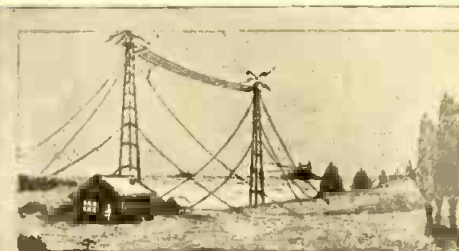

*The Electro-set Co.'s*  
**HANDY BOOK**  
and  
**CATALOGUE**  
EDITION B-2  
"ELECTRICAL THINGS  
FOR EVERYBODY"  
*The Electro-set Co.*  
Leader News Bldg. Cleveland O.  
Price 25 cents

**Postage Paid to  
Anybody—Anywhere**

This is the BIG BOOK you need and want. By actual comparison, the Electro-Set Co.'s Handy Book contains more information than any two twenty-five cent books on the market. For a limited time we will send this big, valuable book to those interested absolutely free of charge. Don't even send us postage. Just write your name and address plainly on a postcard, say "I'm interested in your goods."

**A Few of the Interesting Items  
You Will Find in the Handy Book**

Treatises on Wireless Telegraphy; Simple Electric Measurements; A. B. C. of Electricity with many fascinating experiments; Construction of Aerials. How to Make Selenium Cells; Calculate Wave Lengths; and Code Charts.

Tables and Data on Transmitting Ranges; Spark Voltages; Inductivity; Weights and Measures; Wave Lengths; Specific Gravity; Resistance; Wire Data; and Spark Coil Construction.

**Headquarters for  
Wireless Goods**

Big Values at Low Prices in Wireless Goods, Motors, Flashlights, Novelties, Parts, Raw Materials, Wire, Heating Appliances, Lighting Plants, Toys, Train Sets and other goods. Read about our

- "Red Head" Wireless Receivers
  - 1-6 K. W. Wireless Transformer
  - \$1.00 Telegraph Set
  - \$1.00 Electrical Outfit
  - \$4.00 Professional Tuner
  - Audion Detectors
  - Storage Batteries
  - Raw Materials
  - Binding Posts
  - Experimental Goods
- Send the Postcard TODAY

**SPECIAL PURCHASE  
AND SALE OF GENUINE  
RUMKORFF STYLE  
SPARK COILS**  
\$4.00 Value **\$1.95**

We have secured a limited lot of fine 1/2-inch Rumkorff style spark coils, classical design, with condenser mounted in a beautiful mahogany finished base, spark gap, and special current reversing switch, complete with heavy vibrators and handsomely finished in every detail. These coils were designed to sell at \$4.00 each. By a fortunate purchase we are able to offer them, until sold, at the very remarkable price of \$1.95 each. Shipping weight 5 lbs. They will actually give from 3/4 to 1 1/2-inch spark. To avoid disappointment send in your order today.

**RED HEAD WIRELESS RECEIVERS**

**THE LAST WORD IN SENSITIVENESS**  
By actual test they are from 10 to 27 points more sensitive than any other standard make. A great New York Testing Engineer reports highly in favor of Red Head Receivers. You take no risk! 5 days' trial—and then if they do not fill every expectation we send your money back.



- PRICES**
- 2000 ohms, per pair, complete set, with head band and cord, . . . . . \$5.00
  - 1000 ohms, single receiver only, . . . . . 1.75
  - 1000 ohms, single set, with cord and band 3.00
- Send for our Free Booklet before buying wireless receivers

**BIG TRIAL OFFER  
To "Experimenter" Readers**

For the purpose of further introducing our already widely known super-sensitive Triple A Grade Wireless Minerals, we offer for a limited time only this trial size package of A A A



**10c**

**GALENA** postpaid anywhere in the world upon receipt of 10c in stamps or coin

Nearly all serious wireless experimenters are familiar with our wonderful wireless minerals. Hundreds of testimonials prove our contention that no minerals marketed today can compare in sensitivity to our standardized grades. We make an unlimited guarantee that obviates all risk—Your money back if you are not satisfied.

Send today for this trial package of Famous Electroset Galena. If you do not find more sensitive spots in this small trial package than you can get out of 8 oz. of ordinary galena, we will gladly return your dime. NOTE: Do not confuse this offer with our regular Arlington Tested Individually Packed Galena at 25c postpaid. Arlington Tested Galena will be sent if requested upon receipt of 25c in stamps or coin. Arlington Galena is individually tested for extreme distances and is ultra-super-sensitive.

Send For The Bargain Trial Galena Today

**THE ELECTRO-SET CO.** ADDRESS DEPT. E-9  
CLEVELAND, OHIO  
**ELECTRICAL THINGS FOR EVERYBODY**



# NEW MODEL INSTRUMENTS

New York City, N. Y., February, 1917.  
MR. WIRELESS AMATEUR,  
Anywhere, U. S. A.

My Dear Sir:—Perhaps you have heard of the Electro Importing Co. before. Perhaps you are one of the countless satisfied users of E. I. Co. apparatus. But do you know these FACTS which can be readily proved by any?

The E. I. Co. is the oldest electrical experimental supply house in the world. Established in 1904—13 years old. The E. I. Co. controls more wireless and kindred patents than any other similar establishment in the United States. The company controls ALL the patents of the undersigned, manufacturing and selling all apparatus under these patents.

The E. I. Co. today probably does the largest volume of business in Radio and Experimental Apparatus in the United States. The E. I. Co. ALWAYS has blazed the way—WE LEAD, OTHERS FOLLOW.

LOW. This advertisement—the greatest wireless announcement of the year—proves it amply.

The E. I. Co. has the brains—and delivers the goods.

The E. I. Co. is known to give everyone universal satisfaction.

The E. I. Co. is famed for its SQUARE DEAL.

The E. I. Co.'s standing makes it absolutely safe for you to deal with us. You ALWAYS save money.

The E. I. Co. gives you prompt and courteous treatment.

The E. I. Co. has issued its new Catalog No. 18 containing a wealth of new articles and information. The free coupon brings it.

Respectfully yours,

THE ELECTRO IMPORTING CO.

H. GERNSBACK, President



Our "Government" Receivers have for years been a standard for all to look up to. They have aluminum shells, perfect diaphragms, 5 ft. silk cord and are now supplied with the wonderful "Gernsback Adjustable" Headband. Shipping weight, 3 lbs.  
No. HX-6666 "Government" Wireless Receivers..... **\$8.00**

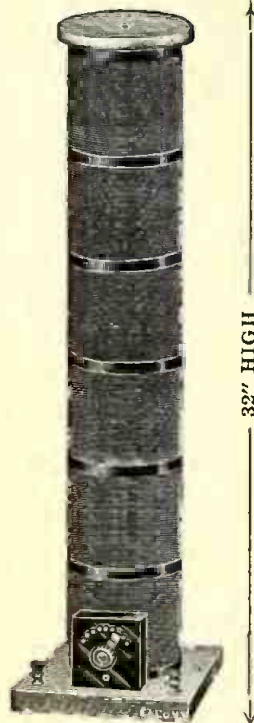

Trans-Oceanic Undamped Wave Loading Coil—15,000 meters capacity. The biggest and best coil of its kind ever developed. Note the size. (32x8x8 in.) Wound with green silk wire on special tubes. Frame of hand-rubbed mahogany. Metal nickel plated. Switch Navy type. Value twice what we ask. Shipping weight, 5 lbs.  
No. HEK-4500 Trans-Oceanic Undamped Wave Loading Coil..... **\$8.50**



The Electro Radio Tone. The newest thing in wireless. A perfect test buzzer at last. Has rubber composition case, is absolutely noiseless, gives a beautiful high pitched musical note and can't get out of adjustment. Our catalog shows several new uses for this instrument. As always, it is the best on the market. Shipping weight, 4 oz.  
No. HX-1800 Electro Radio Tone..... **\$0.80**

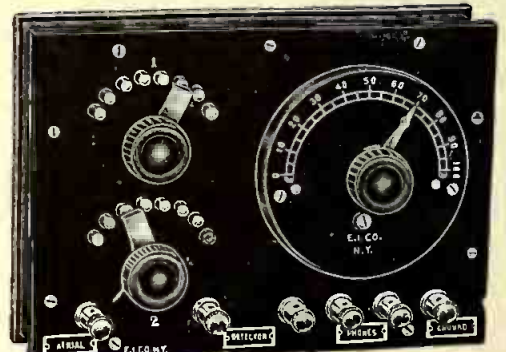

Arlington (NAA) Baby Timer. 120 meters wavelength. All that its name implies and more. Receives long waves perfectly. Has Bakelite front and hand-rubbed mahogany case. All metal nickel plated and polished. Size, 3 1/2 x 6 x 2. No. HEK-4433 Arlington (NAA) Baby Timer (no phones). Weight, 4 lbs..... **\$8.50**

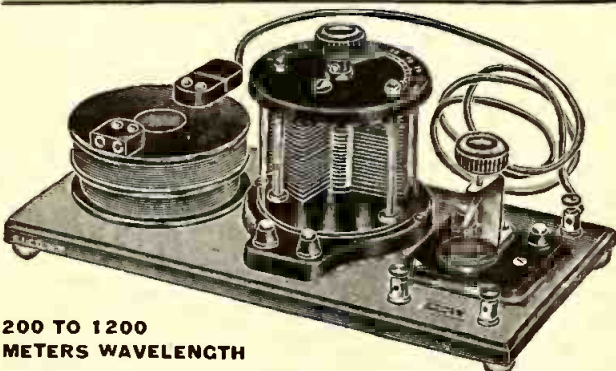

200 TO 1200 METERS WAVELENGTH  
Electro Professional Wave Meter.—The simplest and best instrument of its kind ever offered the public. Has two exploring coils for different capacities. Is supplied complete as shown with full directions and calibration curves. Woodwork hand-rubbed mahogany. Shipping weight, 10 lbs. Reads from 180 to 1800 meters. Accurate to within 3%.  
No. HZ-4488 "Professional" Wave Meter..... **\$8.00**

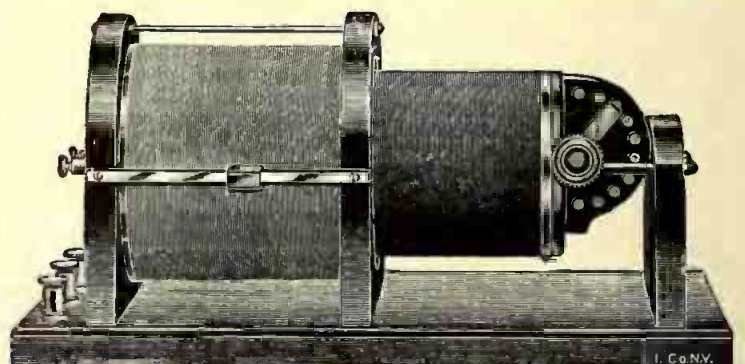

Professional Loose Coupler. The 1917 model of the best coupler on the market at its price. Note the size, 15 1/2 x 7 1/2 x 7 1/4. Tunes up to 3000 meters easily. Navy type switch on secondary with 10 points. Shipping weight, 10 lbs.  
No. HX-14000 Professional Loose Coupler..... **\$8.00**

## THE ELECTRO IMPORTING CO., Mfrs.

231 Fulton Street, New York, N. Y.



# FROM CYCLOPEDIA CATALOG NO. 18

USE THE COUPON BELOW TO GET YOUR FREE COPY OF THIS BIG BOOK. "ITS THE LIVEST CATALOG IN AMERICA"

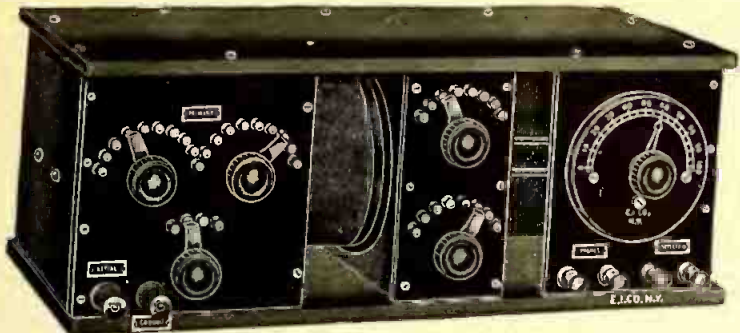

**Tuckerton (WGG) Radio Outfit.** Receives long and short waves in great style. Has the most wonderful Navy type loose coupler you have ever seen. All fronts of Bakelite, metal nicked and case of hand-rubbed mahogany. Size, 21½x7x6¼ in. Shipping wt., 15 lbs. **\$26.00**  
No. BFX-4466 Tuckerton (WGG) Radio Outfit (no phones).

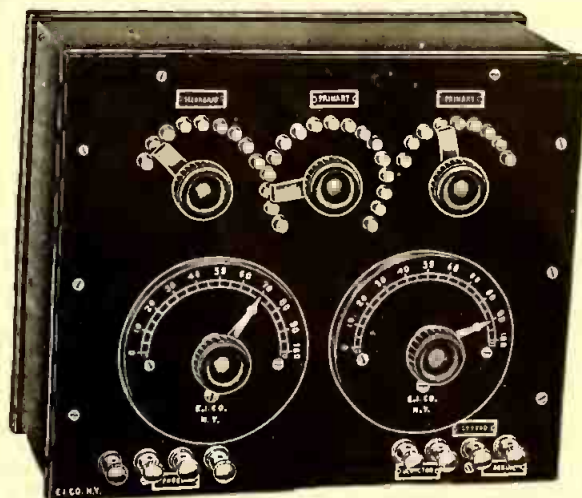

**Sayville (WSL) Radio Outfit.** 2500 meters wavelength. A deluxe cabinet that is compact, efficient, good looking and yet is not expensive. All tuning is by switches, and the front is of Bakelite, the metal highly nicked and the case is of hand-rubbed mahogany. Size, 12x10x5½. Shipping weight, 9 lbs. **\$18.00**  
No. AHX-4455 Sayville (WSL) Radio Outfit (no phones)

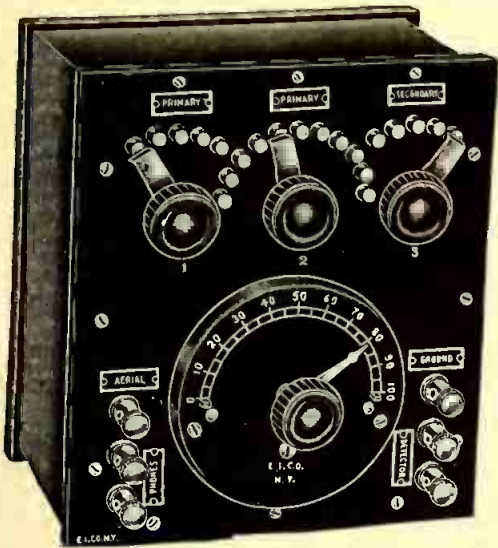

**Key West (NAR) Radio Outfit.** 2000 meters wavelength. Combines more value in a small outfit than any outfit we make. Has made some wonderful long records in tests. Bakelite crystal furnished; also solid gold catwhisker. Heavy Bakelite base. Shipping weight, 6 lbs. **\$14.00**  
No. ADX-4444 Key West (NAR) Radio Outfit (no phones)

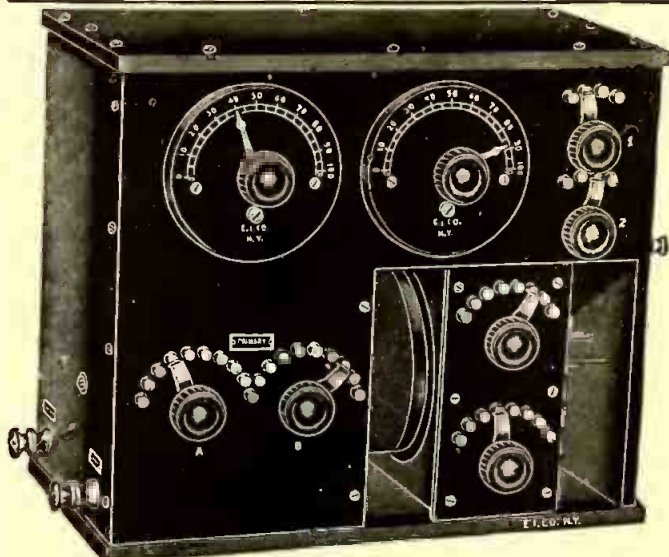

**Nauen (POZ) Radio Outfit.** 3500 meters wavelength. Made to do just what its name implies, to receive European messages, and does it. Has a remarkable Navy type receiving transformer and condensers. Entire front of Bakelite, metal highly nicked and case, size 17½x11½x7, is of hand-rubbed mahogany. A perfect instrument at a very reasonable price. Receives up to 3500 meters without extra coils. A real bargain. **\$39.00**  
No. CIX-04477 Nauen (POZ) Radio Outfit (no phones)

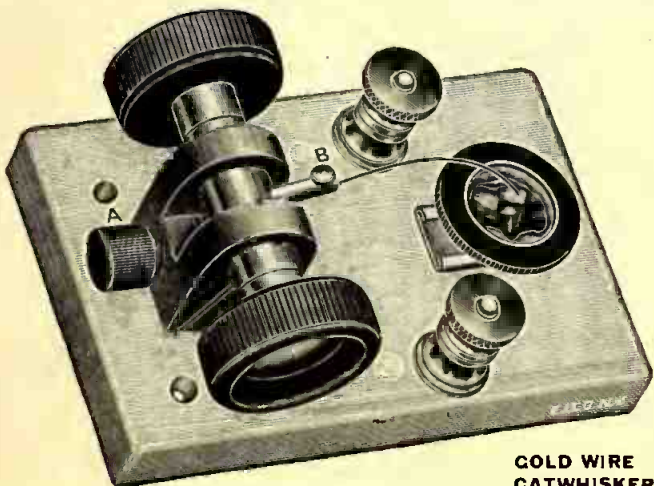

**COLD WIRE CATWHISKER**

**Radiocite Detector.** The newest and best on the market. Most easily adjusted and only one that LOCKS its adjustment. Radiocite crystal furnished; also solid gold catwhisker. Heavy Bakelite base. Shipping weight, 3 lbs. **\$3.50**  
No. CEK-8888 Radiocite Detector

**The Electro Importing Co., Mfrs.**  
**231 FULTON ST., NEW YORK**

# FREE

Yes, entirely free. Our big, new electrical cyclopedia No 18 is waiting for you. Positively the most complete Wireless and electrical catalog in print today. 200 Big Pages, 600 Illustrations, 530 Instruments and apparatus, etc. New Art Section contains finest Radio Outfits made. Big "Treatise on Wireless Telegraphy." 20 FREE coupons for your 160-page FREE Wireless Course in 20 lessons. FREE Cyclopedia No. 18 measures 7x5½". Weight ¼ lb. Beautiful stiff covers.

**"THE LIVEST CATALOG IN AMERICA"**

Now before you turn this page write your name and address on margin below, cut or tear out, paste on postal card and the Cyclopedia is yours by return mail.

THE ELECTRO IMPORTING CO., 236 Fulton St., N. Y. C.

You benefit by mentioning "The Electrical Experimenter" when writing to advertisers.





S. O. S.!

When you get that thrillingly weak SOS you will appreciate the remarkable sensitiveness of our Improved Type A-9723 Head Set. Read this from an amateur wireless operator of Athens, Ga.:

"I have for months been nightly reading amateur stations—on Galena detector—anywhere from 400 to 1500 miles distant, some of them using less than 1 kw., and tests with other phones of higher price than yours fail to give any signals at all from these stations." (Name on request.)

### Stromberg-Carlson Radio Head Set

You will probably find this improved type A-9723 Radio Head Set—wound to 2000 ohms—at your dealer. If not, we will send it direct for \$8.25. Keep it ten days. If it does not do all that we claim for it, if not satisfied that it is the best buy on the market, send it back and we will refund money without question.

Send for Bulletin No. 1006-C giving full description

Stromberg-Carlson Telephone Mfg. Co. Rochester, N. Y.



### Electricians

Get up-to-date in HOUSE WIRING! Save TIME, MONEY, LABOR and MATERIAL by using our 98 GENUINE BLUE PRINT DRAWINGS, containing all the latest diagrams and connections known in house wiring—every diagram and connection up-to-the-minute as used by first class electricians for wiring BILLS, HUNGARIAN ALARMS, LIGHTS, ANNUNCIATORS, FIRE ALARMS and ELECTRIC GAS LIGHTING. These drawings are bound in the form of a flexible book (9 x 12) for convenience in using on the job. Send for them, and if they don't make you more efficient as a wireman and save you many times their cost as a contractor, return them and money will be refunded—you can't afford to be without them. ONE DOLLAR post paid.

PATENT SPECIALTY COMPANY 462 Sanchez Street San Francisco, Cal.

**ELECTRICAL ENGINEERING** men with training are always in demand. Having trained over 2000 young men in the past 23 years in the fundamentals of Applied Electricity, THE BLISS ELECTRICAL SCHOOL, with its well-equipped shops and laboratories, is peculiarly well qualified to give a condensed course in Electrical

**ENGINEERING**

including Mathematics, Steam and Gas Engines, Mechanical Drawing, Shop Work and Theoretical and Practical Electricity, in all branches. Students actually construct dynamos, install wiring and test efficiency of electrical machinery. Course, with diploma, complete

**IN ONE YEAR**

For practical young men with limited time. 25th Year opens Sept. 24th. Catalogue on request. 260 Takoma Avenue, Washington, D. C.

**POWER**

The two horse-power Benninghofen Engine offers great economical power for every purpose. Many new, essential features, including auto throttle governor, not bit and miss governed. Surprisingly low cost. Burns kerosene or gasoline. Runs machinery, pumps water, saws wood, runs separator, churns, etc. Catalog and details free.

C. Benninghofen & Sons, Hamilton Dept. 110-A Ohio

**BOSTON WIRELESS**

Rotary Condenser, 43 plates, .001 M.F., \$3.75  
Tuner, \$2.50. Spark Gaps, 60c. and \$1.00  
Detectors, \$1.00, \$1.75, \$4.00  
Loose Coupler, \$7.50, 1500 Meters

Agent for A. W. Bowman & Co., Adams-Morgan Co. Manhattan Spark Coils. Catalogue for 2c. stamp

M. MUELLER, 18 Devonshire Street, BOSTON, MASS.

**DETECTORS!!!**

Ask for our bargain lists. We have DeForest New and burnt out Detector and Amplifier bulbs, \$2 to \$5.50. A few double filament, tubular bulbs, \$3.50; single filament tubes, \$2.50; LENZITE detectors, \$4.50. Quartered oak, FORMICA paneled bulb cabinets, from \$2 to \$8.00. Regenerative short wave amplifier with bulb, \$21.50. Expert lathe work. FORMICA INSULATION wire. Agents for all high grade apparatus. Let us quote you.

Mid-West Wireless Supply Co., Mattoon, Ill.

### QUESTION BOX.

(Continued from page 837)

due, we believe, to the fact that the average primary input is assumed too high, viz., 1,350 watts. The usual arc potential is about 70 volts. What your true watts input for the six arcs in series is, we do not know.

From the general expression for the radiation current, resistance and wattage, it is apparent that the greater the wave length the lower the efficiency becomes. It has been found that with arcs the best efficiency is realized in any certain station, excited with a small arc, when the radiated wave length is not markedly greater than that of the fundamental of the aerial. The efficiency can also be increased by elevating the aerial as pointed out in Mr. Whitney's discussion and three amperes of radiation current as indicated by your hot wire ammeter seems to us quite low.

### WHAT IS A CANDLE-POWER?

(723.) Philip Ansis, Detroit, Mich., asks:

Q. 1. In illuminating work, what is meant by a standard candle-power?

A. 1. The amount of light emitted by a sperm candle seven-eighths of an inch in diameter and burning at the rate of 7.776 grams, or 120 grains, per hour.

Q. 2. What do you mean by lumen?

A. 2. The standard of luminous flux, being the light radiated from a unit source thru a unit solid angle.

Q. 3. Define mean hemi-spherical candle-power.

A. 3. If there be drawn, from a source equally in all directions either below or above the equatorial plane, lines whose lengths are proportional to the candle-power in these directions, then the mean value of the lengths, either above or below, is the mean hemi-spherical candle-power of the upper or lower hemisphere respectively.

### RADIO TELEPHONY.

(724.) Otto M. Johnson, Seattle, Wash., inquires:

Q. 1. I am enclosing a diagram of connections for a wireless telephone sending

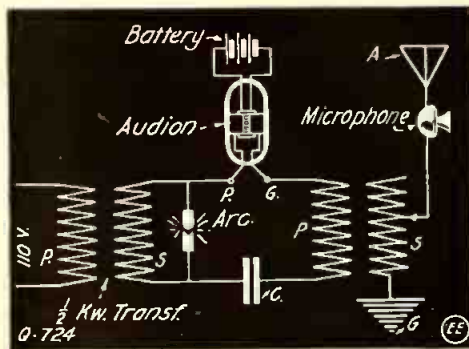

Wireless Telephone Hook-up, Using Audion to Rectify Oscillations, as Proposed by Quicrist.

set, using an Audion detector as a rectifier. The diagram explains it better. I wish to know whether it will work well. The lead from the arc is connected to plate and lead to primary from the grid. The microphone is in series with aerial. If it will not work, please publish a diagram of a circuit that will.

A. 1. Your diagram as submitted to us will not work for the reason that the high tension current from the transformer will pass between the electrodes of the Audion as these are very close together. Furthermore, if rectification exists, very few oscillations would pass thru the antenna circuit. It may work if the tube is of large construction, so as not to permit the high tension current leaking from one terminal to the other.

(Continued on page 842)

### THUNDERSTORMS OF THE UNITED STATES.

(Continued from page 836)

August there is, on the average, a thunderstorm every other day. Thunderstorms are less than half as frequent at the drier, lower places such as El Paso. Tampa has more thunderstorms than any other weather bureau station in the United States. In the three summer months, thunderstorms occur on about two days out of three. The summer on-shore winds supply abundant moisture and the intense sunlight at this low latitude effectively overheats the lower air. Thus the joint distribution of atmospheric instability and moisture dominate thunderstorm frequency.

Parts of Professor Ward's abstract says among other things:

"As essential characteristics of American climate, thunderstorms have a broad, human interest. From the viewpoint of climatology, the distribution of thunderstorms is of more interest than their mechanism. The part played by their rains in watering our crops is of greater importance than the size of the raindrops. The damage done by their lightning and hail concerns us more than the cause of the lightning flash or than the origin of the hailstorms. The thunderstorms of the eastern United States are among the most characteristic of American climatic phenomena. In size, intensity and frequency of occurrence they are unique. (We agree with him.—Ed.)

"In relation to man's activities, it is of significance that most thunderstorms occur at a time of year and at the hours when outdoor activities are at their height.

"Thunderstorms bring us much that is of benefit. To them we owe much, in parts of our country even most, of our spring and summer rainfall. Without these beneficent thunderstorms our great staple crops east of the Rocky Mountains would never reach maturity. One good thunderstorm over a considerable area at a critical crop stage is worth hundreds of thousands of dollars to American farmers. Our stock markets time and again show the favorable reaction of such conditions upon the prices of cereals and also of railroad and other stocks. Thundershowers break our summer droughts, cleanse our dusty air, refresh our parched earth, replenish our failing streams and brooks, bring us cool evenings and nights after sultry and oppressive days."

### Big Electric Auto Bargain!



**FOR SALE CHEAP**—one electric auto.—(coupe). Baker-Cleveland type. Five years old but in A1 condition equipped with new Exide batteries. Forced to sell on account of illness of owner. Machine can be inspected in New York City. Write for particulars at once. No reasonable offer refused.

Box No. 77, c/o Electrical Experimenter, 233 Fulton St., N. Y. City



**LONG DISTANCE WIRELESS RECORD.**

A new world's wireless record for long distance work has been established on the 600-meter wave length. The steamer *Floridian* left San Francisco for Sydney, Australia, July thirteenth. From that date up to and including July thirty-first, the vessel's position was transmitted to San Francisco. The position reports, with one exception, were received directly at the Marconi Hillcrest station, San Francisco, up to a distance of 5,227 miles.

The *Floridian* is equipt with the standard Marconi two-kilowatt, 500-cycle panel set. The current consumption at the transformer did not exceed 1,600 watts up to 2,600 miles, and at 5,200 miles the power consumed was 2,600 watts. San Francisco's signals were audible up to some 3,000 miles.

**WEACO SEMI-QUENCHED ROTARY GAP**

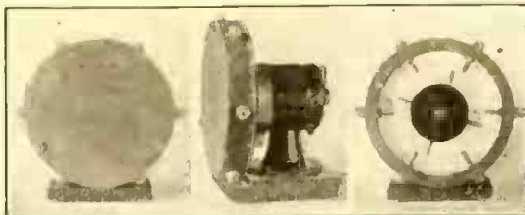

**BAKELITE CONSTRUCTION  
LESS CONDENSER  
GREATER RADIATION  
SEMI-QUENCHING**

A semi-quenched rotary gap utilizing the Venier principle, applied for the first time in the construction of an entirely enclosed gap. Practically noiseless in operation. Enclose 2 cent stamp for Bulletin.

**WIRELESS EXPERIMENTAL APPARATUS CO.**  
130 NORTH 62nd STREET, PHILADELPHIA, PA.

**DID YOU SHOW YOUR FRIEND THE LAST ISSUE ?**

He will appreciate it, you will help us and we will all win out  
Make sure he sees this copy, especially page 862

**THE INCOMPARABLE Tigerman Detecto-Amplifier**

Patents Pending

THE ONLY DEVICE INVENTED WHICH TAKES THE PLACE OF TWO ORDINARY DETECTORS

CABINET RECEIVING SET



**SOME OF ITS MOST SALIENT FEATURES ARE:**

**Oscillator and One Step Amplifier**  
for receiving undamped wave signals and intensifying it 10 to 25 times.

**Detector and One Step Amplifier**  
for receiving damped wave signals and intensifying it 10 to 25 times.

**Detector and Oscillator**  
for receiving both damped and undamped wave signals.

**Two Individual Detectors**  
**Two Individual Oscillators**

**Two Step Amplifier**  
used in connection with another detector.

Price of Individual Tube, \$7.00  
The length of the Tigerman tube is 5 1/2"

PANEL RECEIVING SET

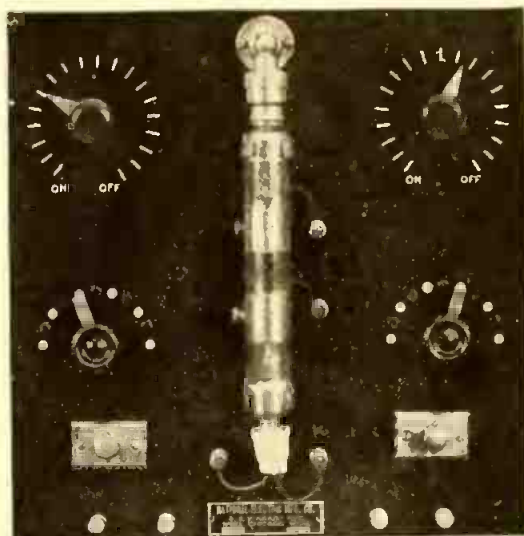

Type "E" with Hard Rubber or Formica Panel, \$27.50  
Type "G" with Mahogany Front Panel - - - 22.50

Type "A" Hard Rubber or Formica Panel - \$20.00  
Type "C" Mahogany Panel - - - - - 16.00

Below are some of our authorized representatives who shall be glad of the opportunity to demonstrate and prove to you the unequal superiority of the TIGERMAN DETECTO-AMPLIFIER. If any of them near you call on him and be convinced.

- |   |  |   |   |  |
|---|--|---|---|--|
| BEAVER RADIO CO., 439 Navigation St., Beaver, Pa.                     | HERBERT J. FERRIS, 19 Howard St., Detroit, Mich.             | ELLSWORTH JOHNSON, 528 13th St., S. E. Minneapolis, Minn.   | NORTHERN STATES WIRELESS CO., 232 S. Duluth Ave., Sioux Falls, S. D.                    | G. & E. RADIO SUPPLY CO., Lowellville, O.  |
| BROOKLYN ELEC. LAMP & NOVELTY CO., 278 Fulton Street, Brooklyn, N. Y. | SETH W. FULLER ELECTRIC CO., 100 Bedford St., Boston, Mass.  | LYNN KEATON, N. Broad St., Norwich, N. Y.   | WERT O'DONNELL, 1222 W. 30th St., Indianapolis, Ind.                                    | THE RICHARDSON CO., Erie, Pa.  |
| J. STANLEY BROWN, 1323 Main St., Menominee, Mich.                     | H. I. GOODALE, 676 Elm St., Buffalo, N. Y.                   | ERNEST LAWRENCE, Canton Public School, Canton, S. D.  | FOLGER C. OUDIN, 7 Union St., Sebectady, N. Y.  | M. E. ROBERTSON, 98 Piermont Ave., Nyack, N. Y.  |
| G. V. H. CAIRNS, 44 Rosedale Ct., Detroit, Mich.                      | HARRY GOODWIN, 609 Emerson St., Watertown, N. Y.             | KENNETH R. LYDE, 20 Clodia Terrace, Newtonville, Mass.  | PACIFIC WIRELESS SPECIALTY CO., 1536 Greshaw Boulevard, Los Angeles, Cal.               | Dr. L. KISMET ROSSA, Sec., Eastern Panhandle Radio Ass'n, 506 W. John St., Martinsburg, W. Va. |
| MAURICE CARNEY, Phoenix, N. Y.  | IRA GOTTSCHALK, 813 13th St., Manitowoc, Wis.                | JOHN J. MARTIN, 414 S. 3d St., Hoopstoen, Ill.  | C. K. PAUER, 110 Main St., West Bend, Wis.  | R. A. SEAGER, Ankona, Fla.   |
| F. N. CLAUSSE, 461 No. 2nd St., Lehigh, Pa.                           | GEO. GROSSMAN, Box 194, Columbia, Mo.                        | FRANK A. MCCOWAN, Box 381, Mason, Mich.   | EARLE B. PERKINS, 134 Pine St., So. Portland, Me.                                       | L. M. SMITH, Salem, Wis. Call 9MA and 9BV.   |
| CLIFF MFG. CO., Brookfield, Mass.                                     | ROBERT H. HARNING, 29 Westfield Ave., Roselle Park, N. J.    | J. C. McIGHAM, 1656 Washington Ave., Northampton, Pa. Call 8TC  | PIONEER AUTO SUPPLY CO., Twenty-second St., at Grand Ave., Kansas City, Mo.             | B. STEDINGER, 1414 S. 10th St., Omaha, Neb.  |
| IRA F. COON, 526 E. 4th St., Lockport, Ill.                           | GEO. E. HARRINGTON, Orleans, Minn.                           | MID-WEST WIRELESS MFG. & SUPPLY CO., Mattoon, Ill.  | PORTLAND WIRELESS EQUIPMENT CO., Morgan Bldg., Portland, Ore.                           | BRAINERD L. STRATTON, 41 Seneca St., Oneida, N. Y.   |
| J. A. CORBELL, Box 937, Ardmore, Okla.                                | THE HINZ ELECTRICAL CO., 234 Palmer Ave., Syracuse, N. Y.    | MIGNON WIRELESS CORP., Elmira, N. Y.  | EDWIN L. POWELL, 216 Spruce Ave., Takoma Park, Md.                                      | AUGUST J. TETE, B. E., 1516 Kerterec St., New Orleans, La.                                     |
| DEAN COTTAM, La Mournie, N. D.  | JOS. M. HOFFMANN, 317 E. 91st St., New York.                 | MODERN ELECTRIC SHOP, Electrical Sales and Installation Dept., Fourteenth and N. Sts., N. W., Washington, D. C. | RADIO APPARATUS CO. OF AMERICA, Parkway Bldg., Broad and Cherry Sts., Philadelphia, Pa. | H. J. VAN BUREN, 921 Marshall Ave., Newcastle, Pa. Call 8QT.                                   |
| MAURICE J. CRAVEN, Spring Valley, Ill.                                | H. A. HOLCOMB, 117 Spring St., Windsor Lock, Conn. Call IATY | M. MUELLER, 18 Devonshire St., Boston, Mass.  | THE RADIO DISTRIBUTING CO., Lombard, Ill.   | E. O. WALTZ, Medina, O.  |
| D. N. S. ELECTRICAL LABORATORY, Quinton, Okla.                        | CHAS. E. HOLMES, 310 Brown St., Grand Rapids, Mich.          | R. J. NICHOLS, 401 Litefield St., Bay City, Mich.   | THE RADIO RESEARCH LABORATORIES, 2148 Fifth Ave., Troy, N. Y.                           | ASHLEY WILLIAMS, 4300 South St., Lincoln, Neb.   |
| GLENN DUNFEE, 607 Fifth Avenue, Shenandoah, Ia.                       | THE IRONTON RADIOSALES CO., 510 S. 7th St., Ironton, O.      | STUART NIVLING, 130 Aberdeen St., Rochester, N. Y.  |   | THE WIRELESS SHOP, 308 Brown St., Ypsilanti, Mich.   |
| NED EACHUS, 37 Court Street, Gallipolis, O.                           | LESTER I. JENKINS, 74 Smith St., New Bedford, Mass.          |   |   | WORCESTER RADIO LABORATORIES, 16 Wayne Street, Worcester, Mass.                                |
| LESTER S. FAWCETT, Independence, Ia. Call 9AIF.                       |  |   |   |  |

This detector does not employ or incorporate an evacuated vessel containing three electrodes, namely, a filament, a plate, and a grid disposed between the filament and plate.

LEARN ALL ABOUT IT! SEND NOW FOR FREE DESCRIPTIVE CIRCULAR

**National Electric Manufacturing Company** Offices and Salesroom: 608 S. Dearborn St., Chicago, Ill.



# Wireless "Mile-Makers"

Greater sending range—steadier current flow—more accurate adjustment—these are the reasons expert operators prefer

# THORDARSON

## WIRELESS TRANSFORMERS

Perfected by the same engineering skill that has won for Thordarson high-tension transformers the Gold Medal at the St. Louis and Panama-Pacific Expositions. Made like a watch and sold only completely assembled. Five sizes, 1/2 to 2 1/2 K.W., 10,000-20,000 volts, any cycle desired.

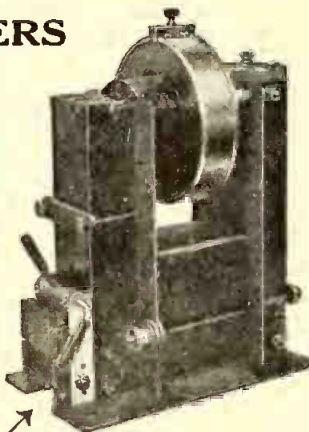

The Variable Shunt (marked by arrow) is an exclusive Thordarson feature enabling the operator to attain perfect resonance by regulating the air-gap. Locked in position by eccentric cam.

Write for Special Bulletin and Prices

Thordarson Electric Mfg. Co., 506 SO. JEFFERSON STREET CHICAGO, ILL.

### QUESTION BOX.

(Continued from page 840)

Q. 2. In the January, 1917, issue, page 693, The American Technical Society publish a diagram of a radio sending and receiving set. They claim it is the best circuit yet. Please give description of instruments if possible.

A. 2. The circuit of which you speak is the one which the Marconi company was using at the time they employed the magnetic detector for receiving. This hook-up is very selective, but is little used nowadays.

### DECOMPOSITION OF WATER.

(725.) Harold Nehls, Kilbourn, Wis., desires to know the following:

Q. 1. How can an alternating current decompose water, so that one-half cycle of the current will decompose the water to receive one atom of oxygen, and the other half of the cycle will obtain two atoms of hydrogen.

A. 1. It is impossible to decompose water by means of an alternating current, as the time interval of the alternating current is so small that there is little chance of decomposing the water. However, the alternating current can be converted into a uni-directional current by employing some form of rectifier, which may be either electrolytic, mechanical or electrical and then using the rectified current for the decomposition work.

### GENERATOR QUERIES.

(726.) A. Baldock, Middlechurch, Mass., wants to know:

Q. 1. What factor governs the current in amperes an A.C. or D.C. generator will deliver?

A. 1. There are several factors in generator design and construction which determine the number of amperes delivered by the machine, but principally the size and number of the conductors used on the armature. It is usual to allow 600 circular mils per ampere for armature conductors.

Q. 2. What factor determines the pressure it will "throw" on the line?

A. 2. The number of conductors, size of the field coils and the speed of the armature are the main considerations which affect the pressure (e.m.f.) delivered by a given machine. Thus a generator having a large number of conductors will deliver a greater voltage than another machine of the same construction, but with fewer copper conductors. The speed of the armature is one factor which controls the voltage; the faster the armature rotates the greater the voltage will be. Also the number of magnetic lines of force delivered by the field coils are important, which quantity of course is controlled by the number of turns on the field coils and the current passing thru the coils (ampere-turns).

Q. 3. What dimensions, i.e., amount of iron, amount and size of wire, etc., should an alternator have?

A. 3. It is impossible for us to go into lengthy details here as to the design and construction of generators in this column, as it requires considerable space to cover this. We would advise you to refer to some standard text book dealing with this subject. There are a number of such text-books on the market which are very simple and easily understood. Write our Book Department asking for a list of them.

## Multi=Audi=Fone

### M.A.F. Short Wave Regenerative Attachment

The M. A. F. Short Wave Regenerative Attachment is the latest and highest achievement in the field of regenerative circuits.

When this instrument is attached to your present loose coupler and Audlon you will be able to receive those long distance relay messages.

With this M. A. F. Attachment the operator is able to receive amateur and commercial stations ranging from 150 to 3,000 meters—damped and un-damped—and amplify both of them to a most remarkable degree.

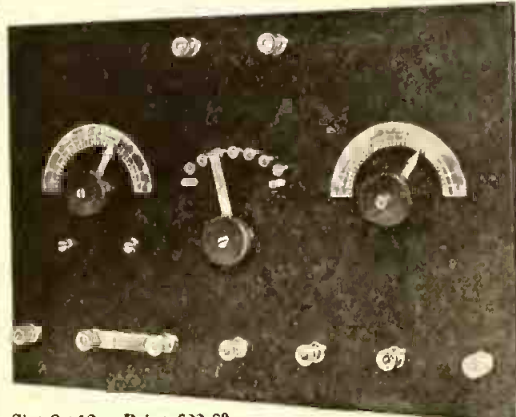

Size 8x12 Price \$22.50

### Multiform Receiver

The Multiform Receiver is the latest development and most advanced step in the wireless field and gives to the operator that comprehensive instrument that he has long looked and hoped for—that is a single receiving set which combines a straight Audion circuit, the new regenerative circuit and long wave un-damped circuit.

On any ordinary aerial the Multiform Receiver has a wave range running from 150 up to 15,000 meters.

- Multi-Audi-Fone, \$18.00
- Pocket Wireless Set, \$5.75
- Two-Step M.A.F., 75.00
- Detectorfone, 35.00
- M. A. F. Detector Stand, 4.25

Send 2c for Circular

## MULTI-AUDI-FONE

275 Morris Avenue Elizabeth, N. J. Size 24x17x12 Price \$100.00

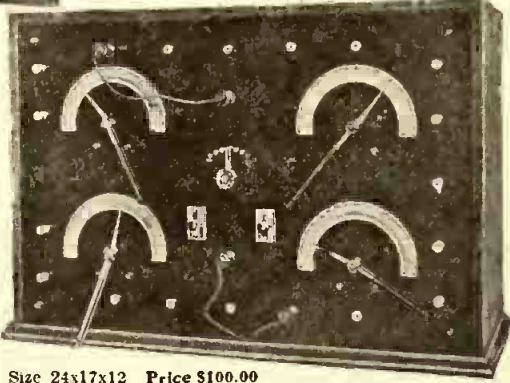

## EFFICIENT TUNERS AT LOW COST

Increase your receiving distances by getting our efficient tuner with switches—the biggest value ever offered for only \$8.00.

Big Undamped Receiving Transformer, 20 taps on primary, 14 on secondary and brings in the German stations fine, only \$12.50.

15,000 Meter Loading Inductance in quartered oak case with 9 taps, only \$8.00. Send 2-cent stamp for bulletins.

COLBY'S TELEGRAPH SCHOOL Auburn, N. Y.



### "BEAT" RECEIVER FOR RADIO.

(727.) Kent Aitken, Tilden, Ill., desires to know:

Q. 1. How to construct a high frequency alternator similar to the one described in the October, 1916, issue of THE ELECTRICAL EXPERIMENTER to be used to receive un-damped waves by the "beat system."

A. 1. The high frequency alternator de-

You benefit by mentioning "The Electrical Experimenter" when writing to advertisers.



scribed in the October, 1916, issue of THE ELECTRICAL EXPERIMENTER can be used for producing beats such as used by Prof. Fessenden in his heterodyne receiver. We would advise you, however, to build the generator with more pole pieces on the rotor than the one described, in order to obtain a greater frequency at a reasonable speed.

Q. 2. How would the alternator be connected with a loose coupler, loading coil, fixt condenser and receivers?

A. 2. The accompanying diagram shows the connections of the alternator in conjunction with the instruments you mention. The only additional instruments required are an inductively coupled coil and a variable condenser. The alternator is linked inductively with the primary of the loose coupler, thru the ground as will be perceived.

Q. 3. Can I receive undamped waves with the above instruments with an aerial 66 feet long and 40 feet high?

A. 3. Yes; providing you employ large enough loading coils to tune the wave length which the undamped wave transmitter is emitting.

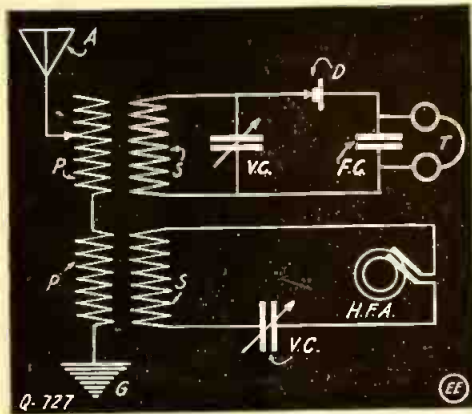

How High Frequency Alternator (H.F.A.) Is Linked Up With Antenna Circuit in Order to Produce "Beats" for Receiving Undamped Waves.

**RESISTANCE MATERIAL.**

(728.) Fritz G. Chappies, Callao, Peru, S.A., asks:

Q. 1. Which will be the best material over which to wind resistance wire for electric stoves provided mica is not available, and what will be the best insulating composition to secure the same resistance wires in place?

A. 1. If mica is not at hand, the next best material to use for winding the heating unit is slate, porcelain or soap stone. German silver wire is often used for making up the heating element. However on larger units, special composition wire is usually employed.

Q. 2. Should the wires work to a red heat, or what will be the best working temperature?

A. 2. The wires should be kept just a shade darker than cherry red. This temperature is best, as the heat developed at this point is quite intensive, but not too much so, to keep the wire in good shape.

Fine Portland cement is recommended as a filler to keep the wires in place. After it has "set," the heating unit is compact and rigid. Rheostats are built in this manner.

**ALTERNATOR QUERY.**

(729.) L. Weiss, Brooklyn, N.Y., wishes to know:

Q. 1. What advantage have constant current alternators over constant current dynamos?

A. 1. The high pressure current is delivered to the external circuit without a commutator, hence there is no sparking difficulty. This relates to the revolving field

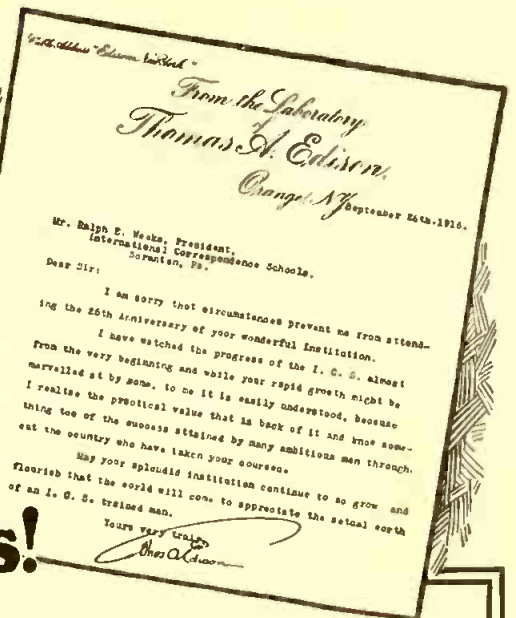
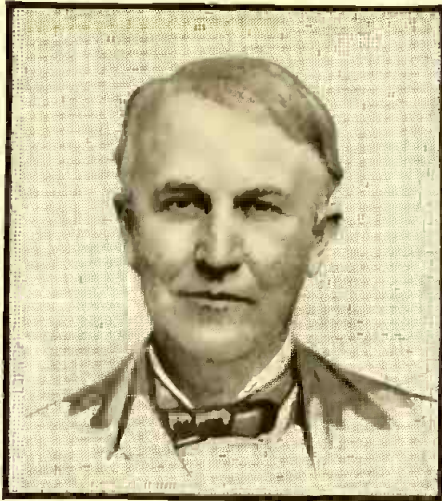

**Edison Knows!**

**H**UNDREDS of thousands of men who have won and are winning success through the International Correspondence Schools will thrill with pride when they read this splendid tribute from Thomas A. Edison.

For Edison knows! He knows the worth of spare-time study. He knows what stuff men are made of who use their spare hours to train themselves for the bigger jobs ahead. And he knows what the I. C. S. will do for the man with the grit to say, "I will."

Wasn't it Edison himself who stayed up half the night to read every get-at-able book on electricity? Didn't he educate himself in spite of every handicap you could ever have?

All big men who have made their mark in the world had the ambition—the determination—to improve their spare time, to train themselves for big work. You, too, can possess power, money and happiness if you'll only make the effort. The reward is great—it's worth it.

Here's all we ask: Merely mail this coupon. Put it up to us without paying or promising. Let us send you the details of others' success through the I. C. S., and then decide. Mark and mail this coupon now.

INTERNATIONAL CORRESPONDENCE SCHOOLS  
Box 5336, Scranton, Pa.

TEAR OUT HERE  
**INTERNATIONAL CORRESPONDENCE SCHOOLS**  
Box 5336, SCRANTON, PA.

Explain, without obligating me, how I can qualify for the position, or in the subject, before which I mark X.

- |  |   |
|--|---|
| <input type="checkbox"/> ADVERTISING MAN         | <input type="checkbox"/> ELECTRICAL ENGINEER        |
| <input type="checkbox"/> Salesmanship            | <input type="checkbox"/> Electric Lighting          |
| <input type="checkbox"/> Commercial Law          | <input type="checkbox"/> Electric Car Running       |
| <input type="checkbox"/> BUSINESS (Complete)     | <input type="checkbox"/> Electric Wiring            |
| <input type="checkbox"/> Cert. Pub. Accountant   | <input type="checkbox"/> Telegraph Expert           |
| <input type="checkbox"/> Highest Accounting      | <input type="checkbox"/> Practical Telephony        |
| <input type="checkbox"/> Bookkeeper              | <input type="checkbox"/> Railroad                   |
| <input type="checkbox"/> Stenographer and Typist | <input type="checkbox"/> Mine Foreman or Engineer   |
| <input type="checkbox"/> Railway Accountant      | <input type="checkbox"/> Metallurgist or Prospector |
| <input type="checkbox"/> WINDOW TRIMMER          | <input type="checkbox"/> ARCHITECT                  |
| <input type="checkbox"/> Show Card Writer        | <input type="checkbox"/> Contractor and Builder     |
| <input type="checkbox"/> Outdoor Sign Painter    | <input type="checkbox"/> Architectural Draftsman    |
| <input type="checkbox"/> Common School Subjects  | <input type="checkbox"/> Concrete Builder           |
| <input type="checkbox"/> Good English            | <input type="checkbox"/> Structural Engineer        |
| <input type="checkbox"/> Teacher                 | <input type="checkbox"/> Plumbing and Heating       |
| <input type="checkbox"/> Civil Service           | <input type="checkbox"/> Sheet Metal Worker         |
| <input type="checkbox"/> Railway Mail Clerk      | <input type="checkbox"/> CHEMICAL ENGINEER          |
| <input type="checkbox"/> CIVIL ENGINEER          | <input type="checkbox"/> Navigator                  |
| <input type="checkbox"/> Surveying and Mapping   | <input type="checkbox"/> Illustrator                |
| <input type="checkbox"/> MECHANICAL ENGINEER     | <input type="checkbox"/> Designer                   |
| <input type="checkbox"/> Mechanical Draftsman    | <input type="checkbox"/> Textile Operator or Supt.  |
| <input type="checkbox"/> Machine Shop Practice   | <input type="checkbox"/> AGRICULTURE                |
| <input type="checkbox"/> Stationary Engineer     | <input type="checkbox"/> Spanish                    |
| <input type="checkbox"/> Gas Engineer            | <input type="checkbox"/> German                     |
|  | <input type="checkbox"/> Poultry Raising            |
|  | <input type="checkbox"/> AUTOMOBILES                |
|  | <input type="checkbox"/> Italian                    |

Name \_\_\_\_\_  
 Present Occupation \_\_\_\_\_  
 Street and No. \_\_\_\_\_  
 City \_\_\_\_\_ State \_\_\_\_\_  
 If name of Course you want is not in this list, write it below.

You benefit by mentioning "The Electrical Experimenter" when writing to advertisers.



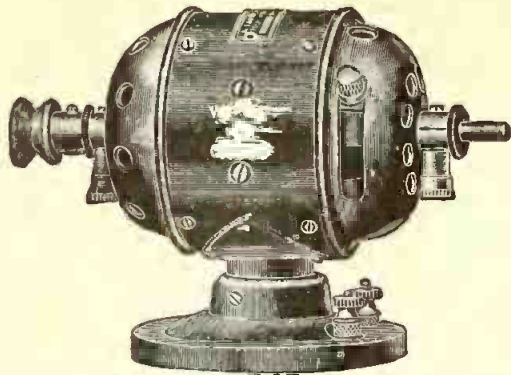

# FOSCO-MOTORS

from  $\frac{1}{25}$  to  $\frac{1}{2}$  h. p.  
Universal, d. c. or a. c.  
Rotary Spark Gaps

This Motor, 6000-8000 r. p. m.,  
a. c. or d. c., 110 volts \$4.75

Electrical Supplies

Send Postage for Catalogue

## The Fosco Corporation

1355 N. Western Ave. Chicago, Ill.



This Rotor complete - \$1.50

## Super-Sensitive Receiving Apparatus

We have a new and wonderful proposition to offer on super-sensitive receiving apparatus, detectors and accessories. Every one interested in wireless should have it. You had better send for it today—now—before you forget.

### Equip Your Sets with INDESTRUCTO Potentiometer Controls

AudioTron Potentiometer and Rheostat Units are made of a special uniform composition and are designed to give silent, easy and close adjustment of battery potentials by a constant and gradual increase not possible with one cell variation.

This results in maximum sensitiveness. The B battery unit is of 7000 ohms resistance, insuring long life to the batteries. Any lower resistance wastes your battery. The AudioTron Indestructo Filament Rheostat, having no wires to corrode, lasts a lifetime. Its ease of adjustment is also a big feature, and it adds to the appearance of your set.



B Battery Potentiometer Unit

B Battery Potentiometer complete \$1.00  
Less Lever and Knob . . . . . .50  
Filament Rheostat complete . . . . . 1.50  
Less Lever and Knob . . . . . .50  
Lever and Knob . . . . . .50



Knob and Lever

READY FOR DELIVERY

OUR NEW COMPOSITION RHEOSTAT gives you the filament control for vacuum detectors you need. Write for description.

Satisfaction Guaranteed

Audio Tron Sales Co. 315 Lick Bldg., San Francisco, Cal.

## UNIVERSAL ELECTRIC MOTORS

OPERATING ON A. C. OR D. C.—110 TO 130 VOLTS

1/40 TO 1/4 H. P.

CATALOGUE FREE



TYPE AK  
\$6.00

THIS MOTOR \$6.00  
1/16 H. P.—6000 R. P. M.

Being Used Successfully for Grinding, Polishing  
Driving Small Machinery, Sewing Machines, Fans, Etc.  
A MOTOR OF UNIVERSAL APPLICATION  
Base Pulley and Chucks Easily Detachable

Complete with  
Pulley  
Emery Wheel  
Buffing Wheel  
Chucks  
Cord and Plug

IF YOUR DEALER CANNOT  
SUPPLY YOU, ORDER  
FROM US DIRECT.

RACINE ELECTRIC SALES CO.  
304 South Dearborn Street CHICAGO, ILL.

type of alternator. There are, however, alternators in which the armature revolves, the current being delivered to the external circuit thru collector rings and brushes. It should be noted that this type of alternator is for moderate pressures and moreover there is no interruption in the flow of current such as would be occasioned by a tangential brush on a dynamo in passing from one commutator segment to the next.

In the revolving field machine, altho the armature current be of very high pressure, the field current which passes thru the brushes and slip rings is of low pressure and accordingly presents no transmission difficulties.

Q. 2. In a constant current series system upon what does the voltage at the alternator depend?

A. 2. The number of devices connected in the circuit, the volts required for each, and the line drop.

Q. 3. Does the difference in transformer capacity represent all the saving?

A. 3. No; one large transformer is more efficient than a number of small transformers connected to the same circuit.

### MAGNETIC ATTRACTION.

(730.) I. Marks, Clermont, N.J., inquires:

Q. 1. How can one calculate the force with which a magnet attracts another magnet or a piece of iron?

A. 1. The force between the two equal magnets can be determined by the area of the common surface multiplied by the square of the number of lines of force per square centimeter divided by 25.14 or multiplied by .04. We have therefore:

$$P = \frac{B^2 A}{8\pi} = .04 B^2 A$$

Suppose two pieces of iron 1 cm. sq. and of any convenient length are bent into two half circles and that the current is sent thru a coil of wire wound about one or both pieces so as to magnetize the iron to a saturation of 5000 lines per sq. centimeter; the force at each point between the two parts of the ring will be  $94 \times 1 \times 5000 \times 5000 = .04 \times 25,000,000 = 1,000,000$  dynes; the total force will be the sum of that at the two joints, or double that at one, hence, the total pull is 2,000,000 dynes. Since 981 dynes equals the weight of one gram, the total pull between the two pieces is 2,000,000 divided by 981, or 2024 grams, or about 4.4 lbs.

Q. 2. How can it be shown that the lines of force tend to become as short as possible?

A. 2. This is illustrated by the well-known phenomenon of attraction as when a magnet attracts its keeper. Familiar examples are the telegraph sounder and the electric bell.

### TELEGRAPH LINE QUERIES.

(731.) L. Kandiel, East Pittsburgh, Pa., wishes to know:

Q. 1. What is meant by quadruplex telegraphy and for what purpose is it used?

A. 1. The quadruplex system as used today provides for the simultaneous transmission of two groups of signals in one direction and two groups of signals in the opposite direction, without interference and over a single telegraph line.

Q. 2. How is a simple duplex telegraph line connected so as to enable one to send simultaneously over the same line without interference?

A. 2. The diagram herewith gives the connections of a simple differential duplex telegraph line. It consists essentially of a differentially wound relay in each station and connected as shown. The resistances R, at each station, are of such magnitude that they are equal to the resistance of the line. This resistance is called the artificial line of the circuit; it is usually shunt-

You benefit by mentioning "The Electrical Experimenter" when writing to advertisers.



ed with a condenser of proper capacity.  
 Q. 3. Is it possible to determine the maximum working distance with the simple telegraph system provided the various factors of the system are known?

A. 3. Yes; it is possible to determine the maximum working distance that one can use the line. The following algebraic expression will answer your question:

$$l = \frac{1}{R} \left[ \frac{E}{I} - 2Rs \right]$$

Where:

- l=maximum distance in miles that you can transmit
  - R=resistance of the line including the ground return
  - E=voltage
  - I=minimum current required to actuate the recording instrument
  - 2Rs=resistance of the recording instrument
- (The factor 2 is used as there are two instruments used in the circuit.)

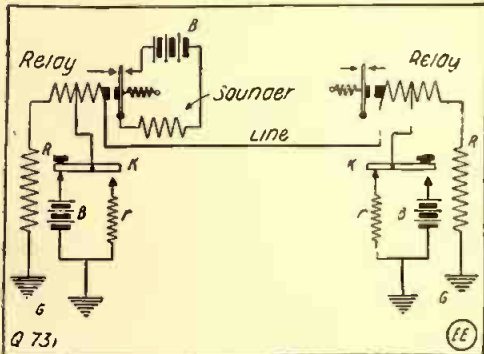

Connection for Simple Differential "Duplex" Telegraph Line, Utilizing Differentially Wound Relays at Each Station.

**CHANGING MOTOR RESISTANCE.**

(732.) F. Jewett, Savannah, Ga., asks:

Q. 1. Is it possible to change the resistance of an armature?  
 A. 1. Only by rewinding it. It should be remembered, however, that part of the resistance of the armature circuit is at the contact between brushes and commutator. Therefore, a motor with an unclean or uneven commutator, loose brushes or poor connections will not run at so uniform a speed as when put in first class running order. Any excessive heat around the brushes or holders should therefore be investigated.

Q. 2. How does a change in the field resistance affect the torque of a motor on a constant potential circuit?  
 A. 2. The effect in such a case is more complicated than in the preceding case, for a change in the field affects the current and both the speed and torque are apt to change in consequence. With a given current, the torque would be increased, by strengthening the field; but the stronger field increases the counter-electro-motive force for the same speed, and this reduces the current. Under ordinary conditions it is found that strengthening the field of a motor on a constant potential circuit causes a more than proportional decrease of current. The result is that within the limits met in ordinary practice, the torque, speed and the power of a motor on a constant potential circuit are actually increased by weakening the field.

Q. 2. How does a change in the field resistance affect the torque of a motor on a constant potential circuit?

A. 2. The effect in such a case is more complicated than in the preceding case, for a change in the field affects the current and both the speed and torque are apt to change in consequence. With a given current, the torque would be increased, by strengthening the field; but the stronger field increases the counter-electro-motive force for the same speed, and this reduces the current. Under ordinary conditions it is found that strengthening the field of a motor on a constant potential circuit causes a more than proportional decrease of current. The result is that within the limits met in ordinary practice, the torque, speed and the power of a motor on a constant potential circuit are actually increased by weakening the field.

**POTENTIOMETER.**

(733.) J. Paldon, Harrison, N.J., writes:  
 Q. 1. Is it possible to employ a potentiometer to measure the e.m.f. of a dry cell?

A. 1. Yes; it is the only positive method of measuring the e.m.f. delivered by a cell. However, the resistance of the potentiometer must be very high. In conjunction with this instrument, it is necessary to employ a standard volt cell connected with a sensitive galvanometer.

# Greater Success through Electricity



The work of the world today is done by electricity. Electricity runs our machines; transports our goods; lights our homes, shops and factories; heats our buildings—is indispensable in hundreds of ways. Opportunities in electricity are greater than ever before. Exact electrical knowledge means more money and greater success for you.

## HAWKINS ELECTRICAL GUIDES

give you ALL the electrical information you want, in the shortest, most concise form—namely, by means of questions and answers and unlimited illustrations. No matter how great or how little your previous knowledge of the subject at hand, you "get the point" at once in Hawkins Electrical Guides. They are absolutely complete—brought right up-to-date—the last volumes are just off the press.

**3,500 Pages**  
**4,700 Illustrations**  
**\$1 A Volume**  
**\$1 A Month**



### 10 Practical Volumes—Flexible Leather Binding—Pocket Size

They are the handiest books to read and to use, ever produced. In flexible, black covers, leather binding—just the right size—5x6 1/2 inches—to fit in your pocket, so that you can carry each single volume about with you until you have mastered its contents. The whole set fits easily in the hollow of your arm, and still there are actually 3,500 pages and 4,700 illustrations.

#### Read What Users Say

- "Every Electrician, Operating Engineer or Student who wants to advance himself in the Electrical field should have a set of these books."  
 JOHN KILLET, 116 Union St. Newark, Ohio.
- "For the man not getting a college training, and even in that case, I can sincerely say I do not believe there is a better set of books on the market today."  
 LORD D. HUFFMAN, Dayton, Ohio.
- "We consider Hawkins Guides the most compact and complete set of electrical references in the market."  
 NOBLE ELECTRIC WORKS, Monterey, Cal.
- "I think they should be in the hands of everyone who has anything to do with Electricity."  
 T. E. MURPHY, Orange, Va.
- "It is the best work an apprentice can study if he wants to get ahead in his trade. As a reference for the experienced worker HAWKINS ELECTRICAL GUIDES are unexcelled."  
 I. McCLELLAN, Chillicothe, Mo.

**PARTIAL CONTENTS OF THE 10 GUIDES**

- No. 1. Electrical signs and symbols, static and current electricity, primary cells, conductors and insulators, resistance and conductivity, magnetism, induction coils, dynamo principles, classes of dynamo, etc.
- No. 2. Armatures, windings, commutation, brushes, motor principles, armature reaction, motor starting, calculators, brake horse power, selection and installation of dynamos and motors, etc.
- No. 3. Galvanometers, standard cells, current measurement, resistance measurement, voltmeters, wattmeters, watt hour meters, operation of dynamos, operation of motors, etc.
- No. 4. Distribution systems, wires and wire calculation, inside, outside, and underground wiring, safe flashers, lightning protection, rectifiers, storage battery systems, etc.
- No. 5. Alternating current principles, alternating current diagrams, the power factor, alternator principles, alternator construction, windings, etc.
- No. 6. A.C. motors, synchronous and induction motor principles, A.C. commutator motors, induction motors, transformers—losses, construction, connections, tests—converters, rectifiers, etc.
- No. 7. Alternating current systems, switching devices, circuit breakers, relays, lightning protector apparatus, regulating devices, synchronous condensers, indicating devices, meters, power factor indicators, etc.
- No. 8. Wave form measurement, switch boards, alternating current wiring, power stations, turbines—management, selection, location, erection, testing, running, care and repair—etc.
- No. 9. Telephones, telegraph, wireless electric bells, electric lighting, photometry, electric railways, electric locomotives, car lighting, trolley car operation, etc.
- No. 10. Miscellaneous applications, motion pictures, gas engine ignition, automobile self-starters and lighting systems, electric vehicles, elevators, cranes, pumps, air compressors, electric heating, electric welding, soldering and brazing, industrial electrolysis, electro plating, electro-therapeutics, X-rays, etc.

Also a complete ready reference index of the complete library

## The entire set of 10 Volumes Shipped to You FREE

Send no money. Examine the books first. Use them for seven days in connection with your work, and decide for yourself that they are the most complete, the most helpful and the clearest written electrical books ever published. This unusual offer is a sign of our confidence in the Guides.

**Easy Payments** Accept the offer now—mail the coupon today. If you decide to keep the books you can make settlement at only \$1 per month until paid for.

**Theo. Audel & Co.**  
 72 Fifth Av., New York, N.Y.

**MAIL THIS FREE COUPON TODAY**

Theo. Audel & Co.,  
 72 5th Ave., N. Y.

Please submit me for examination Hawkins Electrical Guides (Price \$1 each). Ship at once, prepaid, the 10 numbers. If satisfactory I agree to send you \$1 within seven days and to further mail you \$1 each month until paid.

Signature.....  
 Occupation.....  
 Business Address.....  
 Residence.....

Since we have not yet had the pleasure of business relations with you, we shall appreciate your giving us name of reference on line below.

Reference.....

March E E



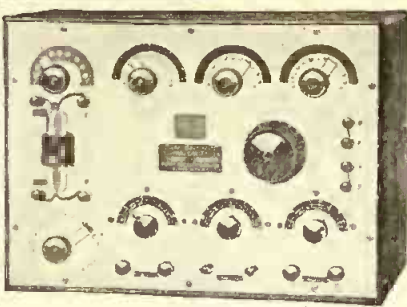

MIGNON UNDAMPED WAVE  
**WIRELESS  
APPARATUS**

Amateur and Commercial Use

This latest Mignon invention is entering a new field in Radio Engineering, eliminating the so familiar LOOSE COUPLERS and LOADING COILS, and introduces adjustable DISCORES, heretofore considered impossible. DISTANCE RANGE UNLIMITED.

**Mignon Wireless Corporation**  
ELMIRA, N. Y., U. S. A.

Write for Catalogue and mention *Electrical Experimenter*



*Holtzer-Cabot*  
**RADIO RECEIVING PHONES**

Read what Experienced Operators say about them and remember—we guarantee every set. Money back if you are not satisfied.

"Have compared H-C phones with other makes costing from \$5 to \$20. The conditions during the tests could hardly have been more varied, ranging as they did from cold, clear atmosphere of winter to static charged month of July. Without exception H-C Phones have proven their superiority."

"We received undamped signals from Nauen, Germany, which is outside of Berlin. We merely used large undamped coupler which would tune up to 15,000 meters, three variable condensers and audion detector.

Holtzer-Cabot Phones were used, without any amplifying device."

"I have used your Light Weight Radio Receivers continually during the past two years, for the reason they have given entire satisfaction and are very efficient in "pulling in" weak signals.

While on the Mexican Border with the Massachusetts Signal Corps we used these telephones and the results were remarkable."

Send for Booklet  
1687X

**The Holtzer-Cabot Elec. Co.** BOSTON CHICAGO

**EUROPEAN STATIONS**

HAVE BEEN RECEIVED WITH THE PHONES ON THE TABLE, using our copyrighted circuits and directions for securing the best results from a single bulb or tubular detector. Circuits for the regenerative, oscillating and amplifying audion. Short and long waves. Amplifying powers with single audion up to one thousand times. No instruments not found in the usual amateur station required. A thousand miles may be covered using only a small indoor aerial. Germany has been repeatedly received on an 85 foot aerial using these circuits. Eight thousand miles common with long aerial. Circuit for using audion in experimental Wireless Telephone transmitter, no arc being required. Circuit for amplifying signals from Audio-Rotor or tikker through audion. Series of 12 blue prints with notes copyrighted 1916, printed with your name, postpaid 50 cents, stamps or preferably silver.

THE RICHARDSON CO., Manufacturers of Radio Apparatus

**MONOTONE  
IMPROVED QUENCHED GAP**



Are you a leader or follower in adopting up-to-the-minute efficient apparatus? Equip your station with the famous MONOTONE IMPROVED QUENCHED GAPS, which are a big improvement over the original MONOTONE GAP. Span that freak distance on powerful waves of RADIO ENERGY. Each plate carefully machined. Best mica. Adjustable. One unit of the new gap for spark coils up to 3". One unit for every 1/4 K.W. power of transformer. Specially recommended for powers below 1/4 K.W. Parts nickled and polished. You will be pleased with this new gap. Guaranteed. Postpaid \$2.50 Each.

ERIE, PA.

Q. 2. What do you consider the best material for building a potentiometer for this kind of work?

A. 2. The simplest method of making such an instrument is by winding German Silver wire upon an insulated form. This wire should be wound non-inductively, and it can be done by doubling the wire and winding both of them on the insulating form.

Q. 3. What do you consider best for selective tuning of either of the following instruments, namely, The Electro Importing Co.'s vario-selective coupler or an ordinary loose coupler outfit?

A. 3. As far as selectivity is concerned, we believe that the vario-selective coupler is better and more efficient than an ordinary loose coupler system.

**RADIO QUERIES.**

(734.) J. Lamat, Long Island City, L.I., asks:

Q. 1. What is the wave length of my antenna, which consists of four wires each 100 feet long and 80 feet high?

A. 1. The maximum natural wave length of your antenna is 340 meters.

Q. 2. How can I reduce this wave length so as to comply with the Government requirements?

A. 2. By connecting a condenser in series with the ground.

Q. 3. What type of antenna do you consider best for transmission work?

A. 3. The "T" type antenna is best suited for general transmitting work.

**INDUCTANCE.**

(735.) Charles Mantel, New York City, N.Y., wants to know:

Q. 1. How does inductance cause the current to lag behind the voltage?

A. 1. It tends to prevent changes in the strength of the current. When two parts of a circuit are near each other, so that one is in the magnetic field of the other, any change in the strength of the current causes a corresponding change in the magnetic field and sets up a reverse pressure in the other wire. This induced pressure causes the current to reach its maximum value a little later than the pressure, and also tends to prevent the current diminishing in step with the pressure.

Q. 2. Why is capacity reactance given a negative sign?

A. 2. Because it reacts in opposition to inductance; that is, it tends to reduce the spurious resistance due to inductance. In circuits having both inductance and capacity, the tangent of the angle of lag or lead as the case may be is the algebraic sum of the two reactances divided by the resistance. If the sign be positive, it is the angle of lag; if negative, it is the angle of lead.

**FLASHER.**

(736.) Paul Andrews, Greenpoint, N.Y., asks:

Q. 1. Upon what principle does the thermo flasher operate?

A. 1. This type of flasher works on the thermal or heat expansion principle; that is, the movement of the contact points of the flasher necessary to open and close the circuit, is obtained automatically by the alternate heating and cooling of a metal bar in the flasher, which causes it to expand and contract.

Q. 2. What should be done with the old electrolyte of a storage battery?

A. 2. When a battery is taken down, the electrolyte may be saved and used when reassembling the battery, providing great care be exercised when pouring it out of the jar, so as not to draw off with it any of the sediment. It should be stored in convenient receptacles, preferably glass or earthenware carboys, which have been



**DEPENDABLE KNAPP Dynamo Motor**  
ELECTRIC SPECIALTIES

**For Boys \$6.25**

For producing current for inductance coils, re-charging storage batteries, electroplating and hundreds of other uses. Well constructed throughout, exceptionally smooth running and highly efficient. A good, strong, durable dynamo.



**AT ALL LIVE DEALERS**  
Insist on your dealer showing you the KNAPP line—KNAPP goods are best. If your dealer cannot supply you, order direct. Send for FREE illustrated catalogue showing a complete line of Electrical Motors and Novelties ranging in price from 10c to \$10.

**KNAPP ELECTRIC & NOVELTY CO.**  
523 West 51st Street, N. Y. City

**ENCLOSED ROTARY GAP**



This gap has been designed to sell at a low price and to meet the demands of amateurs for a good, enclosed and silent gap. Finished in dull black, it will add to the appearance of your set. It is made in one style only, for all powers up to 1-KW. and can be mounted in almost any position. The gap is enclosed in a circular iron housing 8 inches in diameter and 2 1/2 inches thick, with removable cover (for inspection). The adjustment can be as close as desired between sparking points.

Rotating disc is of brass with 12 projecting round brass arms (total diameter 6 inches), mounted on shaft running in bronze bearing and is belt driven by small motor giving a variety of tones depending upon the speed.

**When in operation this gap is very quiet**  
Price complete, without motor, \$8.50  
J. Herbert Ferris, 211 Catalpa Drive, Royal Oak, Mich.

**AN EXCEPTIONAL STATION—**  
At an Exceptionally Low Price

N. A. A. time signals as well as all stations can instantly be attained to without "detector fusing." Our TEL-RADION is included in this station thus eliminating all detectors and trouble. Receiving capacity of this station is thousands of miles with a fairly good capacity aerial. Will tune up to 4,000 meters. An ideal all-round outfit capable of receiving all the commercial stations as well as time signals.

This station includes the following instruments mounted in a birch cabinet, highly finished in mahogany:  
Our COMBINATION TYPE INDUCTIVE TUNER, a seven-point loading coil, capacity 500 metres. Rotary Variable condenser of 43 plates. A Fixed Condenser, our TEL-RADION permanent Wireless Detector, which is controlled by the duplex switch, and our No. C-22 Crystal Detector. A short-circuiting switch is provided to protect the detectors from burnouts if a transmitting station is employed.

**Complete as described, \$23.50**  
With a pair 2000 ohm Brandes headset \$28.00 Complete with aerial, insulators, leading ground wire, heating switch, ground clamp and Brandes superior headset. \$43.50.



**TEL-RADION CO.** 32 Union Sq. New York

**Generators! Alternators!**

We have a complete line of sturdy, efficient generators and alternators from 100 to 1000 watts. We furnish complete parts for these finished ready to assemble with instructions to wind. Transformers made to order. Send for catalogue.

**ALL AT FACTORY PRICES**  
Bergmann Motor Works, 442-446 Niagara St., Buffalo, N.Y.

thoroly washt and never used for any other purpose.

**EDUCATIONAL INSTITUTIONS.**

(737.) C. Bernhardt, Brooklyn, N.Y., wishes to know:

Q. 1. Where can I take a night course in Electrical Engineering somewhere in Brooklyn?

A. 1. There are two educational institutions in Brooklyn where you may learn Electrical Engineering, namely the Pratt Institute and the Polytechnic Institute. The former school offers a two-year course, which is of a practical nature and does not give any degree, while the latter is a College of Engineering and its courses during the day are of four years' duration at the end of which time the student is given a degree in Electrical Engineering when he has completed his course.

Q. 2. How can I obtain information as to the studies given at Yale University, Worcester Polytechnic Institute, Boston Polytechnic Institute and Harvard University?

A. 2. Relative to school addresses would advise that you communicate your inquiries regarding studies, etc., at Yale University to the Registrar, Yale University, New Haven, Conn.; the Registrar of Worcester Polytechnic Institute, Worcester, Mass.; Registrar of Boston Polytechnic Institute, Boston, Mass.; Registrar Harvard University, Cambridge, Mass.

**RANGE OF INSTRUMENTS.**

(738.) J. C. O'Donnell, N.S., Pittsburgh, Pa., desires:

Q. 1. The wave length of a three-wire aerial two hundred feet long and fifty feet high.

A. 1. This aerial has a natural wave length of 400 meters.

Q. 2. The probable range of the following set with the above aerial; two thousand meter loose coupler, variable and fixt condenser, silicon detector and two thousand ohm 'phones.

A. 2. You should have no trouble in receiving 1200 to 1500 miles with your instruments.

Q. 3. Could NAA (Arlington) be received with an eighty-foot aerial and two thousand five hundred meter loose coupler?

A. 3. Yes; providing a proper capacity variable condenser is shunted across the secondary of the loose coupler.

**VOICE-OPERATED TYPEWRITER.**

(739.) The A. T. Co., New York City, wish information on the voice-operated typewriter described in the April, 1916, issue of THE ELECTRICAL EXPERIMENTER.

A. 1. We would advise that the Phonoscribe as developed by Mr. Flowers is not on the market.

The article as published in this magazine was finisht to commercial completion, so to speak, by our editorial staff. However, Mr. Flowers has exercised wonderful ingenuity in devising special arrangements for the operation of such a voice scribe, and, quite possibly, in the reasonably near future, you may be able to purchase such a machine on the open market.

If you wish to inquire into this matter further, you may communicate with Mr. Flowers, addressing him in care of the American Institute of Electrical Engineers, 37 West Thirty-ninth Street, New York.

**AUTOMOBILE HOIST IN WIRELESS WORK.**

Workmen on the masts of the Marconi station at Bolinas, Cal., were raised aloft by means of tackle connected to a touring car, the car engine supplying the hoisting power.

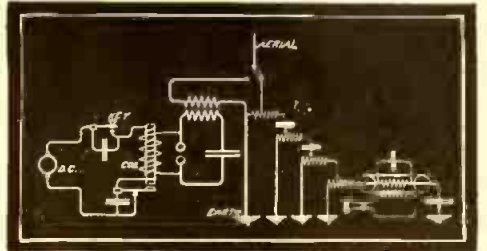

**The Most Modern Circuit for Wireless Stations**

Are you familiar with the efficiency of this new circuit?

Do you know of the progress made during the last year in wireless telegraphy?

Everything about electricity—and wireless telegraphy—is told in the brand new Cyclopedia of Applied Electricity.

**All About Electricity**

In these seven handsome volumes is contained all the knowledge about electricity that 27 experts have gained after years of labor. They are not handbooks—but a complete encyclopedia. The elements of electricity; electrical measurements; generators and motors; machinery; are all explained and carefully diagrammed in this remarkable set of books.

This new edition contains 3,200 pages, and 3,000 illustrations, full-page plates, diagrams, etc. Bound in half-red morocco, stamped with gold.

**50 Cents a Week**

We will ship you the entire seven volumes prepaid, for 7 days' free trial merely upon receipt of the coupon below. Then, if you wish to keep it, pay only \$2 after the trial and \$2 a month (50c. a week) until \$19.80 has been paid. This is a special bargain price offered for a limited time. The regular price is \$35.00.

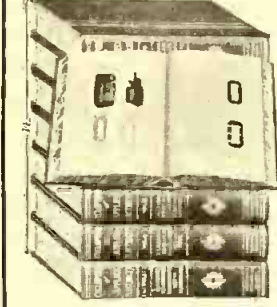

**7 Days' Trial**

Use it just as if it were your own for 7 days; then decide whether or not you want to keep the books. This offer is made to every one within the boundaries of the U. S. and Canada.

**Consulting Service Free**

A year's consulting membership (regular price, \$12.) will be given free if you send your order at once.

**Send the Coupon!**

Put your name and address in the coupon now and send it to us. You won't be under any obligation to buy if you ask us to send you the books on trial. Send the coupon now.

**American Technical Society**

Dept. E. 9443 CHICAGO, U. S. A.

**American Technical Society**

Dept. E 9443 Chicago, U. S. A.

Please send me the seven volume set of the Cyclopedia of Applied Electricity for seven days' free examination. If I decide to buy, I will send you \$2.00 in seven days and balance at \$2.00 a month until \$19.80 has been paid. Then you will send me a receipt showing that the set of books and the \$12 consulting membership are mine and fully paid for. If I think that I can get along without the books, I will return them after 7 days at your expense.

Name .....

Address .....

Reference .....

You benefit by mentioning "The Electrical Experimenter" when writing to advertisers.



**THE WASHINGTON'S BIRTHDAY RELAY, FEB. 24, 1917.**  
(Continued from page 805)

being temporarily out of service. Now all of you wanted something hard, so go to it and get the M.S.G. from New York and also get the one coming from Los Angeles, Cal., as soon as you get these M.S.G.s deliver them to the mayor or highest civil authority in your city and get his receipt and mail them at once to 9XE, Davenport, Ia., no name, just "9XE" that's all, so that I may get to work again and work all night on the write-up, in order that you may read it in your magazine. If you want the wave length of the various sending stations look in the Government call-book; only the sending stations will be given this information, as each will receive a personal letter from the writer in good time before the relay. Now you all wish this hard work on yourself so it is now up to you; the results of the relay depend upon those *who do not send*, those keeping quiet and those asked to send to keep quiet after getting Q.S.L.

We are anxious to get the M.S.G. from both coasts to New Orleans and believe we must use the following route: 6EA, with 6DM and 6SH, alternates if needed, 9ZF, 5DU, Emerson, Dallas, Texas, 9ABD, Corwin, Jefferson City, Mo., 9GY, Kern, Matoon, Ill., 8AEZ, west, Lima, Ohio, 2AGJ, Hewitt, Albany, N.Y., and 1IZ, our old "bright star in the East," Robert T. St. James, who must get it back to New York City mayor thru a local station. 5ZQ, St. Charles College, Grand-Coteau, La., and 5ZD, C. B. De La Hunt, Memphis, Tenn., have agreed to help getting the M.S.G. to 5ZS, W. Anthony, Shreveport, La., if he does not get it direct from 9ZS or 9XV or 5ZC on the way west, but they are asked not to send if 5ZS-Q.S.L.'s promptly, or they will QRM route west at 9ZF.

Mr. and Mrs. C. Candler are requested to get M.S.G. going west from N.Y. and send it on 200 meter wave on a Q.S.T., three times after M.S.G. leaves 9ZN and 5ZC, going west; this is for the benefit of all the southeast stations from Baltimore to Florida, as they will be listening for 8NH. They will also give return M.S.G. from west on a Q.S.T. three times for the benefit of the same stations, but 8NH will not send this M.S.G. on its return from 6EA until 1IZ acknowledges Q.S.L. Station KIX, Denver, and KIW, Mr. Colburn, Ajax mines, Victor, Colo., will be on the job to help us out at this point, which is a hummer and has caused the writer many gray hairs. Among the many special stations agreeing to help are Cornell University, University of Pittsburgh, Ohio State University, Illinois Watch Co., thru our old friend 9ZS, Mr. G. S. Johnson; State University of Iowa, Iowa City; Professor Ford, University of North Dakota, Grand Forks; Professor Taylor, Washington University, St. Louis; Professor Blatterman, to whom with Professor Taylor, we are all indebted for our real information on long distance sending. Rev. Fr. Phillippe, St. Charles College, La.; Rev. Ruth, St. Martins College, and our old friends, Mathews, in Chicago, who is now in charge of Special station 9ZN, formerly 9IK, Corlett 5ZC, Dallas, Texas, who says there are only four states in the country that have not heard my "sigs," and the other well-known boys who have worked hard at the game and on whom will fall the burden of putting this M.S.G. thru. Don't forget boys, we are working against time; so cut out QRM as the special stations are going to try and make better time than the amateurs in these messages, and truthfully I want the amateurs to *lick them to a splinter*. Write 9XE about any Q.R.M.

# VIOLET-RAYS!



NEW LIFE, POWER, HEALTH and BEAUTY in the marvelous delightful VIOLET-RAYS. Newest and most powerful form of electricity, causing neither muscular contraction nor pain of any kind.

## THE VIOLETTA

High frequency instrument is endorsed by thousands of Physicians who use it daily.

Produces SOOTHING, INVIGORATING, CURATIVE VIOLET-RAYS. Wonderfully quick results obtained in treating SCALP, FACE and BODY. Health bringing OZONE forced into the blood, producing an abundance of VITALITY.

### Sent on Free Trial

Simple in construction and operation. The VIOLETTA is especially adapted for personal use in the home. Will operate on alternating or direct current or battery. ABSOLUTELY SAFE and GUARANTEED.

### Write for New Free Book

Send for our new beautifully illustrated book on VIOLETTA. Tells all about the marvels of Violet-Rays. Read what scientists and doctors have to say. Post card brings book and all particulars of special low price and free trial offer.

Dealers write **BLEADON-DUNN CO.** Dept. 1A  
208 NORTH FIFTH AVENUE, CHICAGO

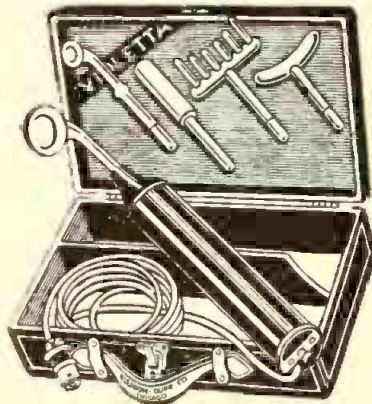

## New Undamped Wave Coupler No. 749

Special Introductory Price, \$18.00

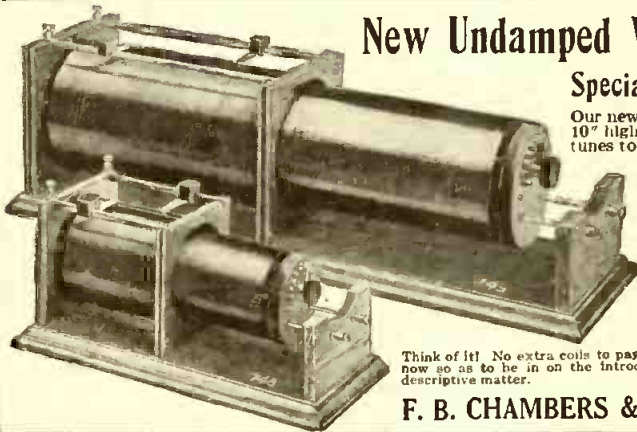

Our new coupler No. 749 is 32" long, 9" wide, and 10" high, over all, and on an average-sized Antenna tunes to 15,000 meters. This coupler, used with the new CHAMBERS' SYSTEM or CIRCUIT, will bring in signals from domestic and foreign Arc Stations surprisingly loud and clear. Note the difference in size of our No. 748 and No. 749.

We claim to be the original inventors of a SYSTEM or CIRCUIT for the reception of the undamped waves without the use of Loading Coils or Oscillating Coils, as they are sometimes called: as with our SYSTEM or CIRCUIT only two Inductively Coupled Coils are necessary. Circuit supplied with each coupler.

This CHAMBERS' CIRCUIT saves you money. Now so as to be in on the introductory price. Orders filled in rotation. Send for descriptive matter.

F. B. CHAMBERS & CO., 2046 Arch St., Phila., Pa.

## Use Bunnell Apparatus

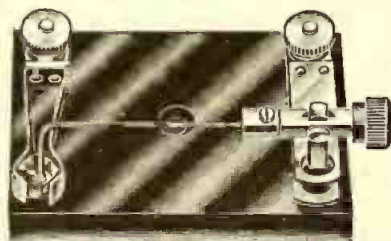

Best and most durable. Up-to-date dealers have them in stock.

Our Catalog 36E illustrates and describes about 300 articles of wireless apparatus as well as other appliances. Send 2c stamp for it, to

No. 8804 Jove Crystal Detector Holder On Dark Porcelain Base \$1.20  
On Handsome Composition Base 1.50

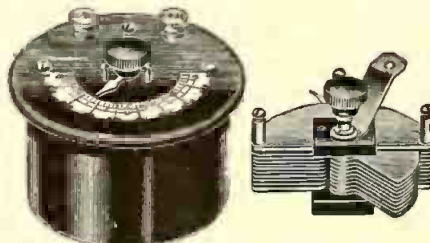

No. 8654 Dandy 21 Plate Variable Condenser \$3.90

J. H. BUNNELL & CO.'S  
Radio Dept.  
32 Park Place New York

# Packard Wireless Transformers

Best For Long Distance Work

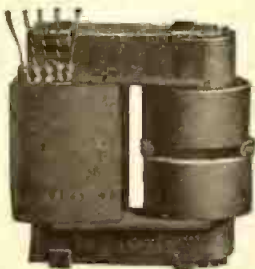

Every user reports exceptional range with these instruments and loud messages are secured every time.

Many amateurs buy one of these unmounted and build their own transformers at low cost.

Write for details and Wireless Bulletin T207

The Packard Electric Company

WARREN OHIO



# LAST CALL!

Only a Few More Left

The greatest bargain ever offered in electrical literature.

A complete volume of the **Electrical Experimenter** bound in rich, dark green linen, stamped with gold letters at the extraordinary low price of

## \$1.25

Postage on 7 lbs. is extra

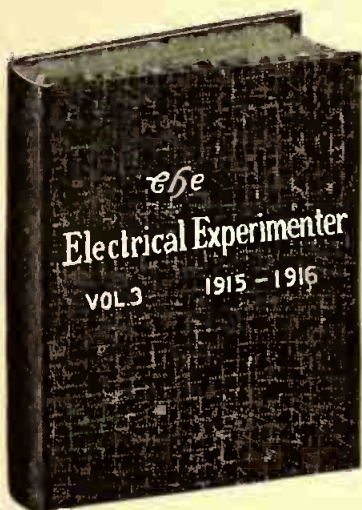

Volume contains twelve numbers, 743 pages, 1,226 complete articles, 1,742 illustrations, 227 questions and answers.

A world of electrical information; the entire electrical Progress for one year; the greatest reference book on current "Wireless"—all at a price as low as the unbound copies would bring. Mind you, the book is durably bound with heavy covers. You will be proud to have it in your library. We have only 100 copies, therefore be sure and order today. Shipping weight 7 lbs. Add a sufficient amount for postage.

Order today to avoid disappointment

**EXPERIMENTER PUBLISHING COMPANY, Inc.**

Book Department,  
233 Fulton Street, New York, N. Y.

whether from commercial or Government stations.

None of the operators at these stations were born with receivers on their ears; they all had to learn and plenty of them have still more to learn; so we hope they will not be so impatient on this night and try to *hog the air*. We hear Government stations every night hogging the air with lots of fool stuff worse than amateurs and numerous commercials calling each other names—we hear you boys, so have a heart and give us a real chance to make good—so we may be able to work *with* you later and not *against* you. The writer's experience in the U.S. Navy taught him that there are many points of etiquette yet to be acquired by the commercial class as a body, but you are all good scouts, so help us out just a little for the "love of mike," and give us just a few minutes out of the 525,600 minutes in the year to try out our schemes.

### PRIZES.

The Thordarson Co., of Chicago, Ill., have donated again a 1K.W. transformer, which you almost won on the Presidential Relay, November 27, 1916. The Electro Importing Co., of New York City, have very kindly donated one of their "Nauen-POZ" Radio Receiving Sets (first prize) and one of their "Professional" Wave Meters (second prize). The W. B. Duck Co., of Toledo, Ohio, have donated one of their celebrated "Arlington" tuners. The Mesco Co., Chicago, Ill., thru their Mr. McGivern,



### DO YOU

own a wireless station, either for sending or receiving? If you do, don't fail to join the greatest Wireless Association in the country: **THE RADIO LEAGUE OF AMERICA**. If you believe in the preparedness of your country, if you wish to help Uncle Sam, if you wish to have your station officially recognized, join the LEAGUE, a national, non-money-making organization. Beautiful engraved and sealed certificate, FREE to all members. NO DUES OR FEES WHATSOEVER.

Honorary Members: **W. H. G. BULLARD, U. S. N.; PROF. REGINALD A. FESSENDEN; DR. LEE DE FOREST; DR. NICOLA TESLA.**

Send stamp for large 8-page information booklet. **DO IT NOW. 233 Fulton St., New York City, N. Y.**

donated a pair of their 3,000 ohm Mesco 'phones. The F. B. Chambers Co., of Philadelphia, Pa., will give a prize and it will be one of their No. 748 or 749 Tuners. The Adams-Morgan Co., Upper Montclair, N.J., will also donate something worth your while and a number of other manufacturers have agreed to give plenty of things. The full list of prizes will be published in the April issue of "EE" and the disposition of them will be determined after consulting the donees and the amateurs of the country after the Relay.

Don't forget the final reckoning will be made after this Relay and the number of credits you receive will determine along with the number received on the last Relay as to who gets the best prize of all.

Letters with receipts of M.S.G. and reports with post-marks on the letters showing they have been mailed more than forty-eight hours after midnight, February 25, 1917, cannot be entered in the final round-up for the write-up so please get busy at once boys and send your dope in at once, i.e., right after the Relay.

We received so many requests to have the Relay on Saturday, February twenty-fourth, that we decided to hold it at that time and if any hitch comes in getting the M.S.G. west or east we will start the same time Sunday night, the twenty-fifth, and do it all over again. Another thing, if the east bound M.S.G. gives any trouble com-

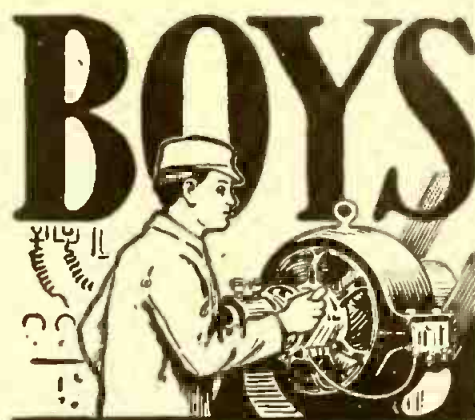

## Big Money in Electricity

The Electrical industries offer wonderful opportunities to boys with a liking for Electricity. The salaries paid to trained men are large, promotion comes rapidly and, best of all, the work is fascinating.

The discovery and development of new lines (such as wireless telegraphy and telephony), from time to time, promise attractive and paying fields to those who wish to specialize. The *will to do* and *Special Training* will bring success to you.

The International Correspondence Schools can help you to become an expert in electrical work, no matter what branch you like best. Thousands of young men have already won success through I. C. S. help. You can do as well as anybody, *if you try*. Everything is made so clear that you can learn in your spare time, regardless of where you live or what your work. No books to buy.

There's big Money in Electricity. Get after it by marking and mailing the Coupon today. *Finding out costs you nothing.*

MARK THE COUPON NOW

### INTERNATIONAL CORRESPONDENCE SCHOOLS

Box 5337, SCRANTON, PA.

Explain, without obligating me, how I can qualify for the position before which I mark X.

- |  |  |
|--|--|
| <input type="checkbox"/> ELECTRICAL ENGINEER     | <input type="checkbox"/> Commercial Law                                  |
| <input type="checkbox"/> Electrician             | <input type="checkbox"/> CHEMICAL ENGINEER                               |
| <input type="checkbox"/> Telegraph Expert        | <input type="checkbox"/> SALESMANSHIP                                    |
| <input type="checkbox"/> Practical Telephony     | <input type="checkbox"/> ADVERTISING MAN                                 |
| <input type="checkbox"/> Electric Wiring         | <input type="checkbox"/> Window Trimmer                                  |
| <input type="checkbox"/> Electric Lighting       | <input type="checkbox"/> Show Card Writer                                |
| <input type="checkbox"/> Electric Railways       | <input type="checkbox"/> Outdoor Sign Painter                            |
| <input type="checkbox"/> Electric Designer       | <input type="checkbox"/> RAILROADER                                      |
| <input type="checkbox"/> MECHANICAL ENGINEER     | <input type="checkbox"/> ILLUSTRATOR                                     |
| <input type="checkbox"/> Mechanical Draftsman    | <input type="checkbox"/> ARCHITECT                                       |
| <input type="checkbox"/> Gas Engineer            | <input type="checkbox"/> Architectural Draftsman                         |
| <input type="checkbox"/> CIVIL ENGINEER          | <input type="checkbox"/> GOOD ENGLISH                                    |
| <input type="checkbox"/> Surveying and Mapping   | <input type="checkbox"/> Teachers Course                                 |
| <input type="checkbox"/> Metallurgist            | <input type="checkbox"/> Common School Subjects                          |
| <input type="checkbox"/> STATIONARY ENGINEER     | <input type="checkbox"/> CIVIL SERVICE                                   |
| <input type="checkbox"/> Concrete Engineer       | <input type="checkbox"/> Railway Mail Clerk                              |
| <input type="checkbox"/> Structural Engineer     | <input type="checkbox"/> AGRICULTURE                                     |
| <input type="checkbox"/> BOOKKEEPING             | <input type="checkbox"/> Navigator <input type="checkbox"/> Spanish      |
| <input type="checkbox"/> Stenographer and Typist | <input type="checkbox"/> Faculty Rating <input type="checkbox"/> German  |
| <input type="checkbox"/> Cert. Pub. Accountant   | <input type="checkbox"/> AUTOMOBILES <input type="checkbox"/> French     |
| <input type="checkbox"/> Railway Accountant      | <input type="checkbox"/> Auto Repairing <input type="checkbox"/> Italian |

Name \_\_\_\_\_  
Occupation, if any, and Employer \_\_\_\_\_  
Street and No. \_\_\_\_\_

City \_\_\_\_\_ State \_\_\_\_\_

If name of Course you want is not in this list, write it below.



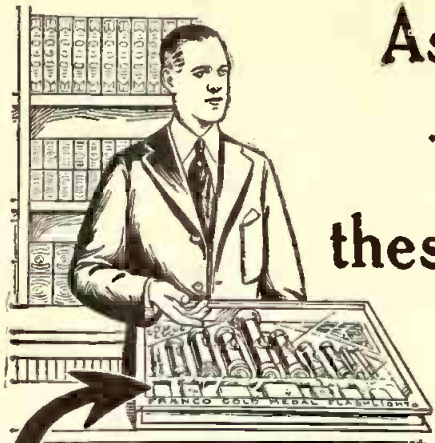

# Ask Your Dealer to show You these Handylights

## They Are Mighty Useful

For finding your way in the dark; for signalling at night; for the thousand and one times when you use matches to light your path, use a safe, sure



They are made in a variety of sizes—one is bound to suit you. With a Radio Battery inside, they will give a brilliant white light lasting a long time. Get one from your dealer's today, or write for illustrated booklet.

**INTERSTATE ELECTRIC NOVELTY CO.**

104-114 S. 4th STREET, BROOKLYN

CHICAGO :: SAN FRANCISCO :: TORONTO

ing from Los Angeles, 6DA, we can have the chance of our lives for a little early morning work and still be in time for church. As a last call boys, do your very best to keep your sets quiet during the Relay—I know it is a tough job to *listen and hear not*—I have been there—but try it just once; take out your fuses and resolve for this one night you will not arbitrarily spoil the work of thousands by a few moments' unnecessary sending. Now I have done my part and the rest is really up to you—go to it and luck to you.

Cordially yours,

9XE,

Davenport, Ia.

The following stations are appointed "monitors of the ether" and will report any Q.R.M. from amateur, special, commercial or government stations; even the *Allies* are requested to keep quiet for a few moments!!

- C. F. Ouidin, 2AFT, Schenectady, N.Y.
- Graceland College, 9YO, Lamoni, Ia.
- The Old War Horse, 9RD, Clinton, Ia.
- O. R. Terry, 9HQ, Stoughton, Wis.
- MacQuarrie, 6SH, Stockton, Cal.
- H. P. Maxim, 1ZM, Hartford, Conn.
- W. A. Parks, 3ZW, Washington, D.C.
- Lieutenant for, 1IZ, Massachusetts.
- D. R. Simmons, 5AX, Shreveport, La.
- D. H. O'Neill, 9DK, St. Louis, Mo.
- Mr. and Mrs. Candler, 8NH, St. Mary's, Ohio.
- C. Dunning, 8YZ, Pittsburgh, Pa.
- F. B. Chambers, 3XC, Philadelphia, Pa.
- H. Brownell, 5AM, Birmingham, Ala.
- W. T. Gravely, 3RO, Danville, Va.
- W. S. Rothrock, 4DI, Winston-Salem, N.C.
- A. A. Herbert, District Manager, A.R.R.L., New Jersey.
- F. F. Merriam, 4CL, Atlanta, Ga.
- S. Greenleaf, 9ZG, Woodstock, Ill.
- W. Reinhart, 9BW, Omaha, Neb.
- W. S. Ezell, 9YE, Wichita, Kans.
- Cedric E. Hart, 6SL, Salt Lake City, Utah.

### THE CALCULATION AND MEASUREMENT OF INDUCTANCE.

(Continued from page 813)

Substituting the values for F' F" in equations (8) and (9) we obtain for F' (1.12) and F" (1.03995). Solving the above we obtain for L=.000198 henry or 198,050 centimeters of inductance.

It will be observed that the shape correction factors are very small and the larger the coil becomes the nearer will they approach unity; for this reason they may be neglected for coils whose diameters are one-tenth that of their length.

For long inductances, such as those used in the regenerative Audion circuits for receiving undamped waves, the above formula is particularly useful. As an example, the inductance of a long wave loading coil, consisting of a single layer of No. 28 S.S.C. magnet wire, wound on a cardboard tube 28 inches long (26 inches of winding) and 5 1/2 inches outside diameter was ascertained to be 76,355,400 cms. Using this coil in series as a loader, with a 4 wire, 500 ft. flat-top, inverted "L" antenna, 100 ft. high, and with a loose coupler primary having 9,400,000 cms. of inductance, the wave length capacity figures out to about 22,900 meters; sufficient for practically all experimental requirements.

The formula given herein for calculating the inductance of coils is for the *current-sheet* value, and apply accurately only to a winding or infinitely thin metal strip, which completely covers the solenoid, the successive turns being supposed to meet at the edges without making electrical contact, and so realizing a uniform distribution of current over the surface. If we have a winding of insulated wire or of bare wire wound in a screw thread, we may have

(Continued on page 854)



### An Opportunity for Experimenters

to secure a GOOD storage battery at a moderately LOW cost. The ONE article you cannot afford to experiment with

The Mark-o-Quality is a storage battery.

# MARKO STORAGE BATTERIES

MARKO storage batteries are especially adapted for operation of all kinds of spark coils, insuring a heavy and powerful spark. There is nothing superior FOR AUDION USE

Type	Volts	Amp. H.R Capacity	List Price	Special price to wireless engineers
4C2	4	40	\$ 7.00	\$4.20
6C2	6	40	10.00	6.00
6C4	6	60	12.00	7.20
6C6	6	80	16.00	9.60

PAUL M. MARKO, 1191 Bedford Ave., Brooklyn, N.Y. New York Depot—974 8th Ave., New York City

## NEW "TUNGAR" RECTIFIER No. 995



This is one of the latest developments of the GENERAL ELECTRIC CO., and is of the hot cathode, argon gas filled type, acting independent of frequency.

Made in three sizes

MAGUIRE & SHOTTON

Special Circular upon request ALBANY - - NEW YORK

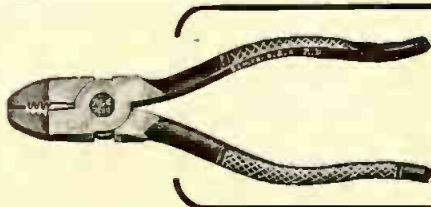

### For the electrical experimenter's repair kit "Red Devil" Combination Plier

A 5 1/2-inch drop forced steel tool combining burner grip, flat-nose and side cutting pliers. Scientific handles fit hand and prevent slipping. From dealers, or if not, from us for 70c. Style No. 325/a.

Tool literature sent free on request

Smith & Hemenway Co., Inc., 107 Chambers Street New York City



**THE U.S. NAVAL OBSERVATORY.**

With increased and increasing speed of our warships, increased fighting ranges, and the continuing development of submarines and aircraft has come the necessity for new and more rapid methods of navigation and plotting, which the Naval Observatory has met by encouraging suggestions, aiding in the development of methods and instruments, making trial of all such as give promise of usefulness and furnishing to the service those that have proved of value.

The usefulness to navigation and to the country in general of the daily time service has been added to by the installation of two up-to-date transmitting clocks and arrangements for checking the actual emission of the radio time signals, which are now received thruout the country east of the Rocky Mountains and the contiguous oceans for several thousand miles, according to the report of the Secretary of the Navy. The time for the country west of the Rocky Mountains and for vessels navigating the north and east Pacific Ocean is sent out from the navy chronometer and time station at the Mare Island Navy Yard.

The routine astronomical work of the observatory for keeping track of the heavenly bodies has been kept up, a photographic zenith tube telescope for determining the variation of latitude added to the plant, and the photographic work extended. One volume of observations and an appendix, "Determination of the Difference of Longitude between Washington and Paris, 1913-14," have been published. The 1916 Nautical Almanac contains improvements and additions over previous issues, and tables have been gotten out to add the times of sunrise and sunset and moonrise and moonset in future editions. For the ensuing year the Naval Observatory will continue its routine work of furnishing time, Nautical Almanacs, and navigational instruments; and it is hoped will be allowed a small appropriation for preparing and fitting out a party to observe the total eclipse of the sun, of June 8, 1918, the path of which will cross the United States.

**SHOOTING BIG GAME ON THE ELECTRIC "MOVIE" TARGET.**

*(Continued from page 793)*

gers, each operated by a separate spring in three-quarters of an inch space is not advisable.

To avoid this difficulty the screen is first divided into zones, and in each zone there are five wires; the zones were represented by letters and the wires by numbers. Thus a bird in the center of the screen would be in front of the ball which connected wire D1 with wire H1. There are vertical zones and horizontal zones. Therefore, to establish the location of any object in the picture, nine fingers were required for the vertical and nine for the horizontal, and at each operation two fingers were necessary, one to establish the zone and one to establish the wire dropt thru the film perforations for the horizontal and one zone finger and one individual finger to establish the vertical wire so that each picture carried four perforations.

A special device has been built for perforating the film and which works automatically. This is the most amazing piece of work ever attempted by any human being and its inventor certainly deserves credit for his time spent in developing the electric moving picture target.

**TRAVELING AT 500 MILES PER HOUR IN THE FUTURE ELECTRIC RAILWAY.**

*(Continued from page 794)*

means of powerful electric solenoids placed along the track, as shown in the accompanying plan view. The details of switching, etc., are not given, as there are several different ways in which this could be taken care of, but in some of the schemes developed in this direction, the opening and closing of the solenoid circuits as the car progresses on its way, is functioned or cared for by the movement of the car itself. In other words the car, as it moves along, passes over a set of electrical contacts placed between solenoid points, so that the solenoid is deenergized just as the car approaches it; the momentum of the car carrying it forward owing to the powerful magnetic pull of the solenoid which had acted on the car a brief instant before. This is the principle upon which electro-magnetic guns operate also.

There is still another way to reduce the initial installation expense of such a railway system, by placing the locomotion coils or electro-magnets within the car, or rather on the car; these moving solenoids to act on iron rings or armatures of suitable cross-section placed along the track. The current can be periodically switched on and off automatically, so as to act in the manner above described, whereby the electro-magnet coil would be deenergized just at the instant where the moving car is approaching the point of maximum magnetic pull. In any event, this particular action simmers down to the point where what is required is a powerful electro-magnetic pull between an iron mass and the electro-magnet.

This all sounds very simple, as well as impracticable, but a system of this kind can be worked out, and has been tried out, in fact, in the laboratory by M. Bachelet and other inventors, with track systems having a length of 1,700 feet and more.

Such a high speed, tubular electric railway system would have many advantages over present day methods of transportation, and one of these is that the peculiar design of such a railway lends itself well to support on a single row of steel towers in the manner shown on our front cover, and the elimination of local stops.

While the hypothesis and ideals of Professor Weinberg as previously outlined, not to mention those of numerous other inventors and scientists, have often been rudely shattered by the more level-headed and slow-going intellects of the day, it really does not seem so rankly impractical to conjecture on the possibilities of such a high speed railway somewhat of the type here described. A fortune awaits the man who is big enough for the job. It wants another Tesla or Edison and he is bound to arrive sooner or later.

**OXYBENZYL METHYLENGLYCOLANHYDRIDE.**

*(Continued from page 801)*

percha, one of the best of the old insulators, a specific resistance but little higher.

BAKELITE-MICARTA is the name of a remarkable material developed a few years ago by the Westinghouse research specialists. Primarily it is an insulating material, but is also a superior product for various other purposes.

Bakelite-Micarta is a hard, insulating material of high dielectric and mechanical strength, which will not warp, expand, or shrink with age or with exposure to the weather. It is infusible and remains unaffected by heat until a temperature is

**WITTE HIGH-GRADE ENGINES**

*Kerosene, Gasoline, Gas, Distillate.*

**2 to 22 H-P.**



For operating belted machinery, elevators, pumps, bone mills, feed grinders, cream separators, crushers, mills, blowers, hoists, etc.—Stationary or Portable, also Saw-Rigs, complete. Largest exclusive engine ED. H. WITTE factory in the world selling direct to the user. Saves \$25 to \$100—Immediate Shipment—Write for latest WITTE prices and catalog of engines. State size wanted or what work you have.—Ed. H. Witte, Pres.,



**WITTE ENGINE WORKS,**  
3937 Oakland Avenue, Kansas City, Mo.  
3937 Empire Building, Pittsburgh, Pa.

**414 PAGES 145 ILLUSTRATIONS**

**I.C.S. ELECTRICAL ENGINEERS HANDBOOK**  
**50¢**  
**ELECTRICITY!**

**H**ERE'S just the book on Electricity that you need to answer your many questions—to solve your knotty problems, to teach you new kinks, to be your memory for tables, rules, formulas and other Electrical and Mechanical facts that some people try to carry in their heads—and fail.

With this "Little Giant" I. C. S. Electrical Engineer's Handbook in your pocket, tool chest, on your work bench, drawing table or desk, an hour or a day need not be lost "digging up" some forgotten rule, some unfamiliar fact; you'll just turn to the very complete index and get it "in a jiffy." Just a few of the subjects treated are:

- Electricity and Magnetism; Electrical Symbols; Batteries; Circuits; Magnets; Direct and Alternating Currents; Dynamos and Motors; Belts; Shafting; Electroplating; Electrical Measurements; Meters; Arc and Incandescent Lamps; Mercury Arc Rectifiers; Transformers; Insulation; Electric Cars; Single and Multiple-Unit Control; Transmission; Rail Welding; Tables of Wires—Sizes, Capacities, etc.—Mathematical Rules, Formulas, Symbols; Tables of Constants, Equivalents, Roots, Powers, Reciprocals, Areas, Weights and Measures; Chemistry; Properties of Metals; Principles of Mechanics; First Aid, etc.

The Electrical Engineer's Handbook is one of 22 I. C. S. Handbooks covering 22 Technical, Scientific and Commercial subjects, all crowded with value. They have the contents of a full-size book condensed into pocket-size ready to go with you anywhere and be at your instant command. They are substantially bound in cloth, red edges, goldleaf stamping, printed from new, clear, readable type on good quality book paper. There is an illustration at every point where a picture will help. Hundreds of thousands have been sold on a money-back guarantee of satisfaction.

The regular price is \$1.25, but for a LIMITED TIME you can buy the ones you want, post-paid, delivery guaranteed, for only 50 cents.

**You Run No Risk! Money Back if Desired!**  
**International Correspondence Schools**  
Box 5338, Scranton, Pa.

**INTERNATIONAL CORRESPONDENCE SCHOOLS**  
Box 5338, SCRANTON, PA.

I enclose \$\_\_\_\_\_ for which send me postpaid the Handbooks marked X, at 50c. each. I may return any or all and get my money back within ten days from receipt:

- |  |   |
|--|---|
| <input type="checkbox"/> Electrical Engineer's         | <input type="checkbox"/> Advertiser's               |
| <input type="checkbox"/> Teleph. and Teleg. Engineer's | <input type="checkbox"/> Business Man's             |
| <input type="checkbox"/> Mechanic's                    | <input type="checkbox"/> Bookkeeper's               |
| <input type="checkbox"/> Steam Engineer's              | <input type="checkbox"/> Steno. and Correspondent's |
| <input type="checkbox"/> Westinghouse Air Brake        | <input type="checkbox"/> Salesman's                 |
| <input type="checkbox"/> Civil Engineer's              | <input type="checkbox"/> Window Trimmer's           |
| <input type="checkbox"/> Coal Miner's                  | <input type="checkbox"/> Cotton Textile Worker's    |
| <input type="checkbox"/> Concrete Engineer's           | <input type="checkbox"/> Farmer's                   |
| <input type="checkbox"/> Building Trades               | <input type="checkbox"/> Poultryman's               |
| <input type="checkbox"/> Plumbers and Fitter's         | <input type="checkbox"/> Mariner's                  |
| <input type="checkbox"/> Chemist's                     | <input type="checkbox"/> Automobile                 |

Name \_\_\_\_\_  
Street and No. \_\_\_\_\_  
City \_\_\_\_\_ State \_\_\_\_\_



## Electric Light for Your Home



The Uni-Lectric is a complete electric service station in home size. Generates standard 110-volt direct current. Big capacity—operates one to 50 lights, electric motors up to 1 h. p., electric irons, electric heaters, vacuum cleaners, force pumps, churns, separators, washing machines, etc.—24 hours a day, every day in the year if you wish. Uses standard lamps and fixtures.

### No Belts—No Batteries

Our patented, high-speed, rotary eleven valve engine operates the modern, high-speed generator with such smoothness that all necessity for storage batteries is eliminated. Thus the renewal of batteries and battery upkeep cost is entirely done away with. Outfit comes in one small compact unit, ready for quick installation. Simple, dependable and economical. The entire outfit guaranteed for five years. Write today for free copy of our new catalog on farm lighting plants.

**Waterman Motor Company**  
112 Mt. Elliott Ave. Detroit, Mich.

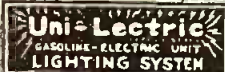
The only home size lighting plant that operates without storage batteries.

## PUT UP A WIRELESS!

The first thing to do is to buy a copy of "Experimental Wireless Stations" New 1916 edition, by Philip E. Edelman. It shows you just what to do, step by step, exactly what you need, what size to make the aerial and where to put it, how to connect up and adjust the apparatus, how to cover any desired distance, how to make your own instruments, etc. 272 pages, fully illustrated, cloth bound. The one book you want, Only \$1.50; postage free.

Insist on getting the new 272-page edition which explains all modern systems, radiotelephones, oscillating and amplifying audions, undamped and long wave sets, etc. A complete list of more than 1000 U. S. radio patents is included for the first time.

**COMBINATION OFFER:** This book will be sent together with "EXPERIMENTS," the famous book of scientific wonders, 256 pp., 100 illus., \$1.50, for only \$2.85 guaranteed.

**PHILIP EDELMAN,** 1802 Hague Ave. St. Paul, Minn.



## FREE

Fine Tones

### \$20 UKULELE MANDOLIN, VIOLIN, GUITAR OR CORNET

We have a wonderful new system of teaching notes music by mail. To first pupils in each locality, we'll give a \$20 superb Violin, Mandolin, Ukulele, Guitar or Cornet absolutely free. Very small charge for lessons only expense. We guarantee to make you a player or no charge. Complete outfit free. Write at once—no obligation.

**SLINGERLAND SCHOOL OF MUSIC, Dept 165, Chicago, Ill.**



## THE GILSON POCKET SLIDE RULE

Patented October 19, 1915

This new slide rule surpasses any other pocket slide rule for accuracy in solving mathematical problems. This instrument will solve any problem involving multiplication, division, proportion, even and uneven roots and powers, Logarithms of numbers and the Sines and Tangents of angles.

Its operation is very simple and anyone can learn to use this slide rule in a few minutes, and can quickly obtain the result of any calculation, for example: Find the cube root of 817, 49; answer 9.351; time required, using a Gilson Pocket Slide Rule, 7 seconds. It is made of heavy waterproof bristol and just fits the pocket—size 4 in. by 7 in. Price with complete instructions, 60c. Imitation leather carrying case 25c extra. Send for free descriptive circulars.

**GILSON SLIDE RULE CO. Niles, Mich.**

## Reliable Supplies for WORKING MODELS

are fully described in our interesting, new illustrated 50-PAGE CATALOG, 5c. postpaid. Write today for a copy. **SPECIAL ORDERS** are promptly and carefully executed by our mechanical department. Submit us your drawings and specifications for quotations.

**IDEAL AEROPLANE & SUPPLY CO 76-82 W. 87thway, N. Y.**

reached that is sufficiently high to carbonize the material. Heat does not warp it, and it will stand an electric arc better than hard fibre, hard rubber, built-up mica, or any molded insulation of resinous or fibrous material. The coefficient of expansion is low—about .00002 per degree Centigrade. It is insoluble in practically all the ordinary solvents such as alcohol, benzine, turpentine, weak solutions of acids and alkalis, hot water, and oils, and is not affected by ozone, a feature that makes it superior to hard rubber, resin, etc., for electrical purposes. It is water-resisting and non-hydroscopic. Bakelite-Micarta can be sawed, milled, turned, tapt, and threaded. It can be punched only in thin sheets and cannot be molded. It takes a good polish and is accurate in thickness within close limits. It is made in various grades in plates, tubes, and rods, all having the same general characteristics, but differing in specific points to adapt them to different kinds of service.

The Bakelite-Micarta plate is made in various grades, having different characteristics. Each grade is designated by a number.

For instance the No. 213 plate is the standard one and is tan in color. It is useful for all applications where high mechanical strength is required, or for general application, on account of its electrical and mechanical qualities. For short periods it will stand temperatures as high as 140 degrees Centigrade and has a breakdown voltage of approximately 400 volts per mil. It will stand continuous service at 25 to 50 volts per mil. Its specific gravity is 1.25, its tensile strength approximately 19,000 lb., per square inch with the grain, and its strength under compression approximately 40,000 lb., per square inch across the grain. It can be sawed to size and drilled and tapt against the grain; it can be punched with simple dies in thicknesses up to  $\frac{1}{8}$  inch. It is furnished in sizes from  $\frac{1}{64}$  to 2 inches thick, up to 36 inches square. No doubt about it—Bakelite fills a distinct want in the commercial electrical field.

### Russia Wants More Electric Stations

A committee on Russian industrial affairs reports that there is need for a rapid increase in the means for generating electric power in Russia. At present there are 93 generating stations with a capacity of 79,533 kilowatts in European Russia.

### EXPERIMENTAL PHYSICS.

(Continued from page 804)

sufficiently large cork stopper is available a milk bottle will be just the thing. Puncture two holes in the cork as far apart as practicable. Bend two hairpins as in figure 9, and stick them thru the two holes in the cork so that they are about  $\frac{1}{2}$  an inch apart at the lower extremity. Soak a wad of cotton about the size of a small marble in gasoline, benzine or ether. Place the wet wad in the bottle and cork the bottle rather tightly. Insulate the leads coming from a small spark coil (a  $\frac{1}{2}$ -inch wireless spark coil works admirably) so that they can be held in the hands. After having moved away to a safe distance (in an extreme case the bottle might burst), touch the ends of the hairpins (a) with the leads. An explosion occurs and the cork stopper is projected upward. Wet another wad of cotton with the same liquid and place it on a piece of asbestos, marble, or slate and light it. It is found to burn quietly without explosion. In the first case the vapor of the gasoline mixed with the air in the bottle and the mixture on being heated by the spark, formed a gas which would normally occupy a much larger volume. This was the case of a large amount

of gas in a small volume exerting a force great enough to cause the cork stopper to be pushed out. In the second case a large amount of gas was also formed but the gas was not confined to a small volume but could occupy the necessary volume in the atmosphere and hence we had no explosion. The gasoline engine is nothing but a contrivance for making explosions in succession; these explosions being utilized to move a piston, which in turn causes a wheel to rotate.

*Experiment 10.* Mix two parts (by weight) of Potassium Nitrat with one part of sulfur and three parts of charcoal. This gives the familiar mixture called gunpowder. If a match is applied to this mixture (it is not advisable to use more than about a teaspoonful) it will be found to burn quietly just as the gasoline did in the preceding experiment. If, however, some of the mixture is placed in a toy cannon and set off by the aid of a fuse, an explosion occurs analagous to the first part of the preceding experiment. The ordinary fire cracker or salute, is nothing but gunpowder packed tightly in a small space and a fuse leading to it. The fuse is nothing but some gunpowder wrapt loosely so that it burns quietly but steadily. A very good way of setting off fireworks for those who wish to celebrate the Fourth of July safely and sanely but noisily, is seen in figure 10. The figure is self-explanatory. The terminals of the secondary of the spark coil (hairpins or heavy wire) are placed so that the protruding ends are close together enough so that the spark will jump across but far enough apart at all other points so that the spark will not jump elsewhere. The switch is placed at a safe distance. This experiment was tried very successfully by a young experimenter, Mr. Arthur Pickett, using a "Bull-dog" spark coil.

If we strike a sharp blow on some of the gunpowder, we notice no effect. If, however, we mix equal parts of Potassium chlorat and Sulfur, we find that the force of the blow is sufficient to set it off. Efficient miniature torpedoes are made by wrapping a *small* amount of this mixture together with a small marble in tin-foil. If thrown up and permitted to land on something hard, such as the pavement, the force of the marble striking is sufficient to detonate it. On mixing four parts of this mixture with one of powdered Magnesium, a good flash powder is made, which can be used for photographic purposes. Finally the ordinary bullet is an application of the principles underlying these two or similar mixtures. Here (d) is a brass shell, (a) is steel or lead, (b) is gunpowder, which on being sufficiently heated, explodes and propels (a) forward; (c) is the fulminate, i.e., the mixture which is set off by the blow of the trigger, the heat given off by which, sets off the powder. (See figure 11.)

Nitrocellulose is a substance far more powerfully explosive than either of these two mixtures and since on explosion it gives off all colorless gases, it is used in the manufacture of smokeless powder. Nitroglycerin resembles nitrocellulose in the violence of its explosive effects. One volume of nitroglycerin yields about 1300 volumes of gas, which by the heat of reaction expands to 10,000 volumes so that the force exerted is indeed enormous. A mixture of Sodium Nitrat, wood pulp and nitroglycerin is called Dynamite, which can be handled with less danger. Recently the Germans have developed a powerful explosive called Trinitrotoluene, which is prepared by the action of nitric acid on toluene. It is a solid and can be transported with safety.

(To be continued.)



# PATENT ADVICE

Edited by H. GERNSBACK

In this Department we publish such matter as is of interest to inventors and particularly to those who are in doubt as to certain Patent Phases. Regular inquiries address to "Patent Advice" cannot be answered by mail free of charge. Such inquiries are published here for the benefit of all readers. If the idea is thought to be of importance, we make it a rule not to divulge details, in order to protect the inventor as far as it is possible to do so.

Should advice be desired by mail a nominal charge of \$1.00 is made for each question. Sketches and descriptions must be clear and explicit. Only one side of sheet should be written on.

### SAFETY SWITCH GUARD.

(128.) John T. Dwyer, W. Philadelphia, Pa., has submitted to us a Safety Guard for preventing electrocution or shocks from touching the metal on knife switches, the safety guard being arranged in such a manner that it will enclose the blade and at the same time help prevent the switch from being opened or closed. Our opinion is asked as to the patentability of the same.

Another device is also submitted, being a spirit level to determine whether a board's surface is horizontally true.

Answer. Concerning the knife switch guard, this is a very good idea, but unhappily, we believe the high cost of making such an article of hard rubber or other insulation, on account of the amount of material needed would make the device prohibitive, as far as its commercial phase is concerned. The idea, nevertheless, is an excellent one.

As to the spirit level, we think this a good idea and a patent might be obtained upon it, but would suggest that you have a patent attorney make a search as to the patentability, first.

### TRAIN STOPPING DEVICE.

(129.) P. Traniello, Natick, Mass., sends us a sketch and writes as follows:

"I am sending you herewith illustration of a train stopping device, which I think will stop a train in case an engineer should try to pass a danger signal set against him. Would like to have your advice as to whether such a system is practical and whether a patent can be obtained on it."

Answer. We have carefully looked over the idea, but it seems to us that the idea is not practical enough to warrant railroads using it. Besides, there is a very similar device used at the present time in the New York Subway, and the usual automatic block systems which are now in vogue all over the country are a great deal simpler, involving less expense, and seem to us to be capable of working with more certainty than the device submitted.

### PORTABLE ELECTRIC BRUSH.

(130.) G. Ladermann, New York City, encloses sketch and description of a portable revolving brush which he thinks would come in handy for porters, who have a good deal of brass to polish, also for jewelers and the like. Is the idea new and is it patentable?

Answer. Nothing new is contained in the suggestion. Merely by putting a revolving brush on a portable motor does not make the article patentable, as no new features are contained in the device. By just taking a motor and mounting some sort of revolving article on it does not entitle you to a patent.

### SELF-SENDING KEY.

(131.) Robert L. Hazeltin, Jamestown, N.Y., has submitted a scheme for a self-teacher to learn the code which is operated

by a motor and perforated tape. Our advice is asked whether this can be patented.

Answer. There is nothing new contained in this idea, which is practically the identical thing being manufactured at the present time by the Dodge School of Telegraphy Co., Valparaiso, Ind., to whom you might write for their catalog.

### COHERER.

(132) Harold Stanford, Lawton, Okla., has sent us in a description and illustration of a special coherer which is excited by electro-magnetic means in a certain manner. Our advice is asked if the device is patentable and whether it has any market value.

Answer. Your device in itself is not new. Similar devices have been patented before. What seems to us as being new, however, is the manner of connecting the coherer to the aerial and ground, which seems novel and possesses several meritorious features. However, without having tested the device we could not offhand tell whether it would be practical for long distance receiving or even for short distance work. We would advise you to have careful tests made before patenting the article.

### SWITCH.

(133) Albert H. Beiler, New York City, asks:

"Will you please inform me of the practicability of a device by means of which a single-pole, single throw knife switch may be made to operate any number of lamps with successive intervals, lighting only one lamp at a time. Thus, by closing the switch, Light No. 1 will light and remain so until the circuit opens again. With the circuit now closed a second time, Light No. 2 will light and remain so until the circuit is again opened, and similarly with any number of lamps.

Answer. The idea is a good one, but without more information about the construction it is impossible to fully advise one. There is unquestionably a demand for devices of this sort, but you should not forget that they must comply with the regulations of the Fire Underwriters, which are very strict, and not all the devices lend

## U.S. PATENTS



**FREE** →  
BOOK-BULLETINS & ADVICE

REGISTERED ATTORNEYS  
**LANCASTER & ALLWINE**  
D.C.

255 OURAY BLD'G, WASHINGTON, D. C.

### Don't Lose Your Rights

We publish form called "Evidence of Conception" by which you can establish your rights before sending the invention to anyone. It is your best protection. We issue up-to-date bulletins of improvements wanted; aid inventors to promote their rights; render reliable opinions free of charge and secure valuable patents and trade-marks on reasonable terms. Personal service assured by our **Service Guarantee Contract**. References: 2nd National Bank, Washington, The John P. Roth Packing Co., Cincinnati.

**SIMPLY MAIL COUPON**

LANCASTER & ALLWINE, 255 Ouray Bldg., Washington, D.C.  
Send me free book "Inventions—Patenting and Promoting," "Bulletins of Improvements Wanted and blank form "Evidence of Conception."

Name .....

Address .....

## PATENT YOUR IDEAS

There is a Constant Demand for Good Inventions

### "WHAT TO INVENT"

and "How to Obtain a Patent"

These Books sent FREE

If you have an invention send sketch for free report regarding patentability; if not send for free book, "What to Invent."

From our advertisements in newspapers manufacturers are constantly writing to us regarding the purchase of patents. Their names and addresses are furnished our clients free of charge. We advertise your patent for sale at our expense.

**DON'T WAIT:** Your invention will never do you any good if some one else patents it ahead of you. Write to us NOW.

**CHANDLEE & CHANDLEE**  
Est. 20 years. 950 F St., Washington, D.C.

## HIGH-VALUE PATENTS

—the ONLY kind Wanted and BOUGHT by Manufacturers.

Send 8c. postage for new book of Extraordinary Interest to Inventors.

**R. S. & A. B. LACEY**  
63 Barrister Building, Washington, D. C.

## PATENTS WANTED

Write for List of Patent Buyers who desire to purchase patents and What they will pay for them. \$1,000,000 in prizes offered for inventions. Send model or sketch for Free Opinion as to patentability. We have a Special Department devoted to Electrical Inventions and are in a position to assist and advise inventors in this field in the development of their inventions.

**MODERATE FEES--WE ASSIST INVENTORS TO SELL THEIR PATENTS**

Write To-Day for our Five Books sent free to any address. (See attached coupon:)

-----FREE COUPON!-----

**VICTOR J. EVANS & CO., Patent Attorneys**

NEW YORK OFFICES: 189-191 Broadway PHILADELPHIA OFFICES: 1429 Chestnut St.

Main Offices: 779 9th Street, N. W., WASHINGTON, D. C.

GENTLEMEN: Please send me FREE OF CHARGE your FIVE Books as per offer.

NAME .....

ADDRESS .....

You benefit by mentioning "The Electrical Experimenter" when writing to advertisers.





### A Ratchet Hand Drill

is a necessity because you are most apt to get into crooked corners in doing small work.

### MILLERS FALLS HAND DRILL No. 306

has ratchet on crank handle which is operated by simply raising and turning a knob to right or left. Detachable hollow handle will hold all drills up to 1/4 capacity of chuck.

Here's a hand drill made up to the quality standards that such a tool deserves.

Ask your dealer to show you Mechanic's Handbook, containing much valuable mechanical information never before printed, and pocket catalog free on request.

**MILLERS FALLS CO.**  
 "Toolmaker to the Master Mechanic"  
 MILLERS FALLS, MASS.  
 N. Y. Office 28 Warren Street



## WANTED-IDEAS

Manufacturers are writing for patents procured through me. **FREE**: 72-page guide book, "Successful Patents"; "Stepping Stones" (containing hundreds of inventions wanted, etc.); and "Patent Promotion" (tells how to sell your rights; chief causes of failure, etc.) Send for them. Free manufacturing facilities. Advice free.

RICHARD B. OWEN, 164 Owen Bldg., Washington, D. C.

## PATENTS

THAT PROTECT AND PAY Books and Advice Free

If you want to sell your patent, take it out through my office. HIGHEST REFERENCES. BEST RESULTS.

WATSON E. COLEMAN, Patent Lawyer  
 624 F. Street, N. W. Washington, D. C.

## MONEY IN PATENTS

We secure your patent or return our fee. Send sketch or model for free search of Patent Office Records and report on patentability. Manufacturers are writing for patents secured through us. Write for free book, "How to Secure Your Patent," and list of patents wanted. We assist in selling your patent.

P. H. PATTISON & CO., U. S. Patent Attorneys  
 427 Barrister Bldg., Washington, D. C.

## INVENT SOMETHING. It May Bring Wealth.

Our Free Book Tells What to Invent and How to Obtain a Patent through OUR CREDIT SYSTEM.

WATERS & CO., Succeeded by TALBERT & PARKER,  
 4287 Warder Building, Washington, D. C.

## TOOLS

For shop, factory, garage and home —many high class tools attractively priced in our Odds and Ends pamphlet which is mailed free on request by

Montgomery & Co., Inc., 105 Fulton St., N. Y. City

themselves to commercial exploitation for that reason. We would advise you to get in touch with a patent attorney.

### THE CALCULATION AND MEASUREMENT OF INDUCTANCE.

(Continued from page 850)

a greater or less self-inductance than that given by the current sheet formulae. This depends upon the ratio of the diameter of the wire to the pitch of the winding. Taking L for the actual self-inductance of a coil and Ls for the current-sheet value as found by any of the formulae herein cited, we obtain the expression:

$$L = L_s - DL;$$

The quantity DL is found by solving the following equation:

$$DL = 4\pi \times a \times n(\Lambda + B);$$

Wherein  
 a = mean radius of coil in cms.  
 n = whole number of turns in coil.  
 $\pi = 3.1416.$

While A and B are constants to be taken from the accompanying tables I and II. The correction term A is dependent upon the size of the bare wire, having diameter "d," as compared with the pitch "P" of the winding, or on the value of the ratio —

The two values must be in units of like denomination, i.e., either in cms. or in inches. When the value — becomes less

than 0.58, A is negative and in such cases when the numerical values of A are greater than those of B, which is always positive, the correction DL becomes negative, and hence L will be greater than Ls.

The correction in the inductance value for high frequency circuits may be made as follows: Subtract from the inductance L, as above corrected, one-half the length of the conductor on the coil in centimeters.

TABLE I

Values of Correction Term "A," depending on the ratio — the Diameter of Bare and Covered Wire on the Coil P

d/P	A	d/P	A	d/P	A
1.00	0.5568	.80	0.3337	.60	0.0460
.99	.5468	.79	.3211	.59	.0292
.98	.5367	.78	.3084	.58	.0121
.97	.5264	.77	.2955	.57	-.0053
.96	.5160	.76	.2824	.56	-.0230
.95	.5055	.75	.2691	.55	-.0410
.94	.4949	.74	.2557	.54	-.0594
.93	.4842	.73	.2421	.53	-.0781
.92	.4734	.72	.2283	.52	-.0971
.91	.4625	.71	.2143	.51	-.1165
.90	.4515	.70	.2001	.50	-.1363
.89	.4403	.69	.1857		
.88	.4290	.68	.1711	.50	-.1363
.87	.4176	.67	.1563	.45	-.2416
.86	.4060	.66	.1413	.40	-.3594
.85	.3943	.65	.1261	.35	-.4928
.84	.3825	.64	.1106	.30	-.6471
.83	.3705	.63	.0949	.25	-.8294
.82	.3584	.62	.0789	.20	-1.0526
.81	.3461	.61	.0626	.15	-1.3403
.80	.3337	.60	.0460	.10	-1.7457

TABLE II

Values of the Correction Term "B," depending on the Number of Turns of Wire on the Single Layer Coil

No. of Turns	B	No. of Turns	B
1	0.0000	50	0.3186
2	.1137	60	.3216
3	.1663	70	.3239
4	.1973	80	.3257
5	.2180	90	.3270
6	.2329	100	.3280
7	.2443	125	.3298
8	.2532	150	.3311
9	.2604	175	.3321
10	.2664	200	.3328
15	.2857	300	.3343
20	.2974	400	.3351
25	.3042	500	.3356
30	.3083	600	.3359
35	.3119	700	.3361
40	.3148	800	.3363
45	.3169	900	.3364
50	.3186	1000	.3365

[In the next installment we will describe a simple but accurate method of measuring the inductance of coils.—Editor.]



### WANTED—Railway Mail Clerks

COMMENCE \$75 MONTH INCREASE TO \$150 MONTH  
 Common education sufficient.  
 Sure pay. Life job. Pull unnecessary.  
 Franklin Institute  
 Dept. W104 Rochester, N. Y.  
 Sirs: Send me without charge, sample Railway Mail Clerk Examination questions; list of other government jobs now easily obtainable and free book describing them.

COUPON

Name.....  
 Address.....

### FREE Send for large Catalogue of Practical Mechanical Books FOR HOME STUDY

Best Books for Electricians, Telephone Men, Motion Picture Operators, Engineers, Railroad Men, Motormen, Draftsmen, Automobile Mechanics, Plumbers, Carpenters, Builders, Sign and Card Writers, also Bookkeepers and Civil Service Applicants.

**F. J. DRAKE & CO.**  
 Dept. 6, 1006 Michigan Ave. CHICAGO

**AUTOMOBILE STARTING AND LIGHTING MANLY**

Sent Postpaid for \$1.00

### EXPERIMENTERS!!

WE SPECIALIZE IN SEAMLESS CARDBOARD TUBING IN SIZES SUITABLE FOR TUNING COILS, LOOSE COUPLERS, TESLA COILS, Etc.

SPECIAL GRAY TUBES  
 18"x6 1/2"x6 3/8" \$1 ea. 18"x7 1/2"x7 3/8" \$1 ea.

PRICE LIST  
 Smooth Wound Wireless Tubes  
 Outside Lgh. Price Par. Post  
 3 x 7 1/2 .12 .18  
 3 1/2 x 7 1/2 .12 .18  
 4 x 7 1/2 .15 .22  
 4 1/2 x 7 1/2 .20 .27  
 5 x 7 1/2 .25 .31  
 5 1/2 x 7 1/2 .25 .33  
 6 x 7 1/2 .30 .37

GENERAL INFORMATION  
 These prices include PARCEL order and remittance. We CAN NOT furnish these tubes in longer lengths than 7 1/2" unless ordered in quantities of 100 of a size. We CAN furnish SPIRAL WOUND TUBES in any length up to 45 inches at .02 per inch in the following inside diameters, 3 1/2-4 1/2-5-6.

BEEBLE & MACLEAN MFG. CO.  
 21 BROMFIELD ST. BOSTON, MASS.

*Learn to Write*

I can make a good penman of you at home during spare time. Write for my book "HOW TO BECOME A GOOD PENMAN" and beautiful specimens, all Free. Your name elegantly written on a card if you enclose stamp. F. W. TAMBLYM, 424 Meyer Bldg., Kansas City, Mo.

### RED OR BLACK "Vulcan" Ink Pencils

The ONLY perfect, non-leakable ink pencils at moderate prices. Order Today \$1

Two sizes—1 1/4 and 4 1/2 inches. Extra Size—8 inches (black ink) \$1.25. Your name in gold inlay, 35c. FREE—liberal supply of ink with retail orders. Agents Wanted. Big Profits.

J. R. ULLRICH & CO., 27 Thames St., NEW YORK

### FREE This Complete Set of Drawing Instruments

\$15.00 Draftsman's Complete Working outfit, absolutely free. They do not cost you a penny on this offer. Write for particulars.

**\$150.00 to \$300.00 a Month** My graduates are earning from \$150 to \$300 a month and more. Write Today. Send for my free book on drafting. No obligations. Write now. Chief Draftsman Dose, Div 8388 Engineers Equilm't Co., Chicago



**JANUARY MEETING OF THE A.I.E.E.**

The American Institute of Electrical Engineers held their 328th meeting on January twelfth under the auspices of the Pittsburgh Section of the Traction and Transportation Committee at the Fort Pitt Hotel, Pittsburgh, Pa.

An interesting paper entitled "Regenerative Braking of Electric Vehicles" was presented by R. E. Hellmund of the Westinghouse Electric and Manufacturing Company. This paper presented an exhaustive study of regenerative control as applicable to the various systems of electrical railways; and in view of the wide possibilities which exist for successful regeneration, the subject of regenerative braking is now rapidly assuming considerable commercial importance. It possesses many practical advantages in electric railway work and for heavy railroads, as well as in various other fields, such as steel mills, etc., which cause this subject to be of particular interest to electrical engineers engaged in railway work and other industrial applications of electric power.

**THE QUENCHED SPARK GAP.**

(Continued from page 815)

the same amount inserted in the secondary circuit, multiplied by the square of the ratio of transformation. The opposite holds true in the case of capacity, which is transferred from one circuit to the other by dividing by the ratio squared. Reactance, as stated before, behaves like resistance. Our reactance adjustments can be most conveniently made in the primary side of the transformer.

The condenser C is connected across the secondary terminals of the transformer without any other apparatus. Its capacity may be roughly determined by the usual power relations, assuming the voltage is known, and should be made adjustable.

When the apparatus has been arranged as shown, the primary mains are connected to the transformer and the current indicated on the ammeter noted when Rp has been adjusted to maximum indication. The capacity at C is then increased until the maximum is again obtained and its value noted. This procedure is gone thru for the different capacities and the corresponding ammeter readings entered in a table. Care should be taken that the condenser capacity does not exceed the limiting value set by the equation:—

$$C = \frac{\lambda^2}{3552L};$$

where L represents the primary radio inductance for the wave length to be used. Any excess of this value would not permit of sufficient inductance in the primary of the oscillation transformer to permit of efficient energy transfer to the antenna. The condenser capacity which gives the largest ammeter reading at resonance should be the one used. If the primary of the transformer is provided with taps for power variation, each tap should be measured in terms of resonant condenser capacity and tabulated for reference. It is possible that the reactance in the primary of the transformer of the closed core type will not be needed for some adjustments, but the condensance of the total circuit should be increased so that the adjustments may be made by this means, as greater flexibility is then obtained.

It will be noted that the writer has referred to the closed core transformer as being the best for quenched gap work. This question of difference between the two types of transformer has been disputed for several years and various opinions have



# 50¢ a Week

**YES**, for this insignificant sum you can get the great 1916 edition of the **Cyclopedia of Applied Electricity**. See it before you decide to buy. No matter what you want to know about electricity—here it is at your fingers' tips. The great authorities have written it in plain English—so that you can grasp it instantly. These books mean more money for you—promotion—the position you have been dreaming about, and all you need to do to get the entire seven volumes is to send us your name and address. Use them seven days at our expense before you decide if you want to buy.

## All About Electricity!

The 1916 edition of **Cyclopedia of Applied Electricity** contains 3,500 pages, 7x10 in.; 3,000 illustrations, full-page plates, diagrams, etc.; hundreds of valuable tables and formulas; carefully cross-indexed for quick, easy reference. Printed on special quality paper and bound in half red morocco, gold stamped. Seven volumes. The standard of America—the information that is vital to you and to every man who is interested in electricity. And it is yours—on a startling offer.

**Shipped FREE!** Don't send us a penny. We will send the entire seven volumes prepaid right to your home, so that you can see and examine them for yourself. **Keep them seven full days.** Then decide if you can get along without them. If you think you can, send them back. If you keep them, pay \$2.00 after the seven days' trial—and then \$2.00 a month (50c a week) until \$19.80 has been paid. You are the sole judge—you do not risk a penny. This offer is open to everyone in the U. S. and Canada.

- Read These Subjects**
- Elements of Electricity—
  - Electrical Measurements—
  - Underwriters' Requirements—
  - Theory, Calculation, Design and Construction of Generators and Motors—
  - Dynamo-Electric Machinery—
  - Lighting Machinery—
  - Power Transmission—
  - Electric Railways—
  - Power Stations—
  - Switchboards and Switching—
  - Storage Batteries—
  - Applied Electro-chemistry—
  - Electric Elevators—
  - Electric Welding and Heating—
  - Wire and Wireless Telegraphy.

## Consulting Service FREE!

A year's Consulting Membership (regular price \$12.00) will be given free if you send your order at once. The advice of an entire corps of electrical experts is yours—to help you in your progress—for a whole year **FREE!**

## Send the Coupon

See these books for yourself before you decide to buy. Remember—don't send us a penny. Just fill out the coupon and mail it. Will send you the entire seven volumes *prepaid*. Use them seven days—then if you want to buy pay the special reduced price at the rate of \$2.00 a month. Send the coupon now. Your ambition says—act—see for yourself.

American Technical Society  
Dept. E 7443 Chicago, U.S.A.  
Please send me *Cyclopedia of Applied Electricity* for seven days' free examination. If I keep the books will send \$2.00 within seven days and \$2.00 a month until \$19.80 has been paid, when books and Consulting Membership will be mine. Otherwise will notify you and hold books subject to your order.

**AMERICAN TECHNICAL SOCIETY**  
Dept. E. 7443 CHICAGO, U.S.A.

Name.....  
Address.....  
As I have had no previous dealings with you, I refer you to.....





### Don't Monkey With the Buzz-Saw

and don't experiment with an unreliable brake. It is dangerous business. Experienced cyclists for the past sixteen years have given consideration to only one brake—the



#### DUPLEX COASTER BRAKE

Its reliability is known. It has proved itself dependable thousands and thousands of times under all riding conditions. Cyclists know they can trust it, because it has never failed. Through actual service it has earned its reputation as the standard brake equipment—100% efficient.

"Corbin Control Means Safety Assured"

Powerful, durable and sure; smooth in action, easy of operation, gradual or instant of grip. There is no doubt about it, the Corbin Duplex is the only brake you can afford to equip to your bicycle—old or new. It doubles the fun and safety of riding. Insist on the Corbin Duplex. It is the only brake for you to use. At all bicycle dealers'. Ask for it.

The Corbin Screw Corporation  
The American Hardware Corp., Successor  
216 High Street, New Britain, Conn.  
Branches: New York, Chicago, Philadelphia  
Makers of Corbin-Brown Speedometers

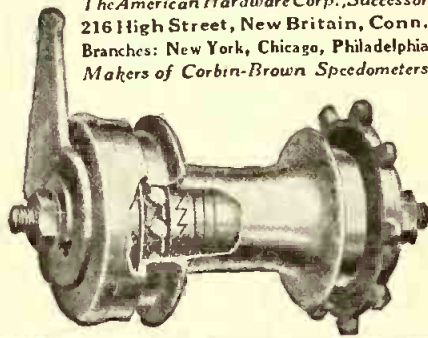

#### Convert Your Bicycle Into a Motorcycle

Motor fits any wheel. Best, most reliable. Best hill climber. More STEFFEYS in use than all others. A fine motor for running small Dynamos, Lathes and small shops. Motors only as low as \$16.95

Steffey Mfg. Co., 5025 W. Brown St., Phila., Pa.



**\$40** and BICYCLES at cut prices. Singles and twins \$25 to \$100. New Mo to cycle Tires \$3. Automobile Tires \$3. Best Motorcycle Belts \$5. Carburetors \$6. Spark coils \$6. Second-hand Bicycles \$5. Tandems \$15. New Bicycles at Factory Prices. Deulinger, The Price Outter, Rochester, New York

been express. The reasons why the author has suggested the use of the closed core type are as follows: In favor of the open core type, it might be said that it possesses the desirable high leakage characteristic and is simple, both in design and construction. The closed core type requires less copper and iron for a given output, and consequently the losses are smaller and it is more efficient. The relative space taken up by the two forms favors the closed core type also. It will be seen that the closed core instrument is to be preferred. However, the open core type can be used, provided a suitable reactance is inserted in the primary to compensate for the leakage reactance of the other type. This is in addition to the adjusting reactance used in the preceding experiment, and can be incorporated in the adjusting reactance itself.

It has been the experience of various engineers working with the quenched gap that a detuning of the transformer circuit about 15 per cent off the resonant frequency just determined was desirable in order to obtain a clear note. This may be done later when the gap is put in operation by readjusting the reactance in the primary. An explanation of this detuning process as given by a well-known engineer is somewhat as follows:

Referring to Fig. 2, which represents the variation and phase relations of the current with the various reactance adjustments as abscissae, the heavy dotted line drawn parallel to the  $R_p$  axis indicates the zero phase axis. Above this line capacity predominates and the primary current leads, while below it the current lags. It will be observed that the current curve has an asymptote on an axis at right angles to  $R_p$  at the resonance point. In other words the current at this point reaches a high value, and is limited only by the resistance of the circuit. This would indicate that the point of exact resonance does not represent a safe working condition owing to the excessive current obtained. Of course this could be controlled by means of resistance, but this would reduce the efficiency of the apparatus and it will be found better to detune from the resonant frequency. The shaded portions of Fig. 2 show the operating regions after this is done.

The question now arises as to the difference between these regions. It will generally be found that operation in the region marked II will give the best results, from the standpoint of spark clarity. From A to B the current will lead, causing a rise of generator voltage because of the rapid reduction of initial gap resistance, due to the fact that currents in this phase relationship cause the armature reaction to aid with greater extent the generated E.M.F. In the region C to D the opposite holds true, i.e., that the voltage will fall as the resistance of the gap drops, resulting in practically a uniform current thru the gap, and a pure note. This is probably the reason why it is better to work above the resonant point rather than on or below it. Experiment under the actual conditions is the only means by which the exact operating point may be determined.

Referring to Fig. 3, it will be seen that the quenched gap G and inductances  $L_1$  and  $L_2$  of the radio circuit have been connected in, and coupled to the antenna circuit. Previously, however, the two radio frequency circuits are tuned to resonance and the coupling adjusted until the two emitted waves lie close together. Call this the critical coupling. Now, using all the gaps at hand, the mains are connected to the primary and the set operated. Allow the gap to operate for about five to ten minutes, in order to complete the chemical reduction in the sparking chamber.



### Strong of Limb and Keen of Eye

—growing more husky, hale, hearty, robust, deep-chested, pink-cheeked, red-blooded every day—that's your boy when he rides a 1917 Electrically Equipped

# Indian Bicycle

Nothing like an Indian to keep him outdoors where he can broaden mentally and physically, where he will be in daily contact with the type of boys you want him to cultivate.

And in the Electrically Equipped Indian he has the strongest, most highly perfected bicycle money can buy. Snappy streamline Indian Motorcycle effect, attractive red finish, Indian tank battery holder, Indian crank hanger, Indian front fork with quadruple crown and braced members, Indian rear wheel stand, Indian cross-bar motorcycle type handlebars, brake, front and rear mud guards, Troxel saddle, large electric light, powerful reflector. All Indian built and backed.

Indian Electrically Equipped Bicycle, \$45; ten other models, \$26 to \$45. Write for 1917 Bicycle Catalog.

Makers of the famous Indian Big Twin with Powerplus Motor, Side Car, and Light Twin with Four Cycle Opposed Motor.

**HENDEE MANUFACTURING CO.**  
826 State St. Springfield, Mass.  
Largest Motorcycle Manufacturers in the World

## PORCELAIN

"THAT'S OUR BUSINESS"

Standard and Special Shapes, Regardless of How Difficult

We illustrate one hard shape we make. A pair of rolls  $7\frac{1}{2}$ " long and  $1\frac{1}{4}$ " in diameter with 8 holes on ends and middle. They must be perfectly straight and we make them so. It's hard but not for us. We can make your difficult designs also. Send us blue print for quotations.

**Union Electrical Porcelain Works**  
TRENTON, N. J.



If the gap has not been previously *seasoned*, it will take a longer time for this action to ensue, for the reasons previously pointed out. By listening in on a wave meter, the pitch and clarity of the note may be determined, and when this has been partially cleared the current may be shut off. Now from the table obtained during the resonance adjustment just made on the transformer circuits, find the amount of reactance to be used in series with the primary. Set Rp to this amount and place the set in operation again, listening in on the wave meter (or receiving set). Vary the amount of reactance in series, keeping above the resonance point, until the note is clear and the current in the primary is at a maximum. The coupling may be adjusted at the same time as the reactance exercising care not to deviate from the critical coupling by a large amount. If an integrating wattmeter of the indicating type is at hand, it should be placed in the primary circuit of the transformer and used to determine the point of maximum power. Finally the antenna current is noted and the point at which the primary power or current is maximum, and when the ratio of this power to the radiation current is maximum, the note of the spark clear and the wave lengths not too far apart, the transmitter may be said to be operating at its highest efficiency at the wave length used. This adjustment should be made for all taps on the power variation switch on the primary of the transformer, and the values of the various units tabulated for future reference when it is desired to use less power.

It may be found in reference to the antenna current that the hot-wire type of ammeter is not sufficiently sensitive to follow the changes of current when the quenched gap is used, and the adjustments of coupling, etc., may have to be made slowly in order not to miss the maximum. It is suggested that this form of current measurement be replaced with the thermo-junction and milli-voltmeter, calibrated in terms of R.M.S. amperes. The author hopes at some future date to give a more detailed description of this apparatus and some of the results obtained by its use.

By reading carefully the foregoing paragraphs, and also by extending the study of this gap to other available publications there is no doubt that some of the misconceptions concerning the quenched gap may be corrected and it may then enjoy a more extensive use. This gap will not raise the frequency of the spark, nor will it do any other of the astounding and phenomenal things sometimes claimed for it, but it will allow a reduction of decrement of the radiation, at the same time increasing the efficiency of the transmitter and giving the spark a clearer tone.

In order to aid those who have as yet had no experience with quenched gap design or who have met with failure in their previous attempts, the writer has included the design of a small gap suitable for use on a 60 cycle, quarter K.W. closed core transformer having a secondary potential of the order of 10,000 volts or under. In case it is desired to increase the spark frequency and at the same time retain the desirable quenching qualities of the quenched gap, it is recommended that a rotary gap and the quenched gap be connected in series, as has already been suggested by Mr. Blatterman.

Referring to the Fig. 4, the various parts of the gap may be seen. The plates are cut from sheet brass, or cast and trued on a lathe. The general experience, however, will be that it is better to cut them from 1 1/2-inch bar stock, as the chucking is simplified and the waste is not great.

A word might be said in regard to the gaskets. This has been the cause of fail-

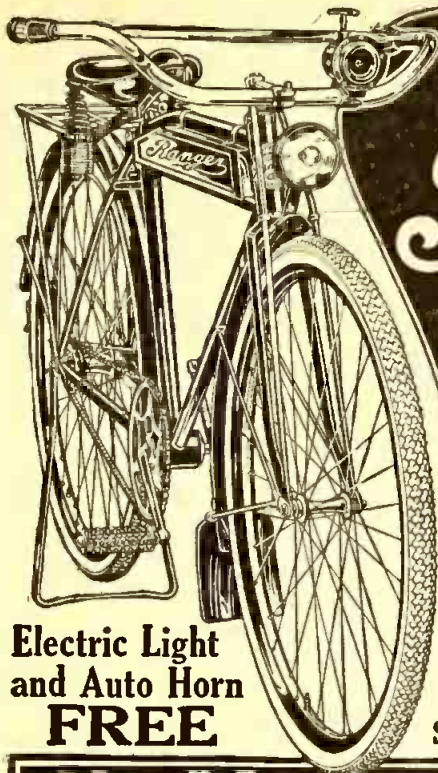

The Famous  
**Ranger**  
1917  
Motorbike

Sent Anywhere On  
**30 Days Free Trial**

**We Pay the Freight**

Your Choice of 44 Styles  
Colors and Sizes in the famous Ranger Line of Bicycles for Men, Women, Boys and Girls. Also

**83 Other Styles \$14.75 and Up**

Five Year Guarantee **FREE**  
and Accident Insurance

Send Coupon Now for Wonderful Offer

Electric Light  
and Auto Horn  
**FREE**

**No Money In Advance**

Don't hesitate. You can get this famous Ranger Motorbike or any other bicycle you want without one cent in advance—no red tape or delay of any kind. Just your mere request brings the bicycle of your choice—the size and color you want, equipped in every particular to suit you. When the bicycle comes, you can decide to keep it on our 30-Day Free Trial Plan or send it back at our expense. We won't persuade you to keep the bicycle. The bicycle in your own hands, under every day use, must sell itself to you, or we'll take it back, and not charge you one cent for the use of it.

**The Greatest Bicycle Ever Built**

We have spared no expense to make the Ranger Motorbike the best and most completely equipped bicycle in the world. It not only excels in construction, but it also answers the cry for SPEED. It furnishes extra riding COMFORT. Its ENDURANCE is remarkable. It is a BEAUTY in appearance. Altogether it stands without a rival—on country road, on steepest hills, on city boulevards, on forest trail.

**Note This Wonderful Equipment Free**

You'll simply fall in love with every detail—the Special Curved Motorcycle Frame with Re-inforcing Top Bar, the Front Fork reinforced with Truss, the Steel Tool Box between Top Bars, which looks exactly like gasoline tank on motorcycle. Special Features are:—Motorbike Handle Bars, Grips and Pedals, Coaster Brake, Patented Motorbike Saddle, Quick Detachable Mud Guards, Imported Brampton Roller Chain, Electric Light, Auto Hand Horn, Sampson Tires. In addition, we give you FREE, a \$5 Tool Accessory Outfit described on this page.

**Special—Now**

Get this Motorbike or any other Ranger, model including \$5 Premium Set, 5-Year Guarantee, Accident Insurance. Send coupon for Big Book showing all styles, sizes, colors from which to choose. We'll ship bicycle freight charges fully prepaid. If you believe it the grandest bargain and greatest bicycle ever offered, keep it on our 30-Day Free Trial Plan, or return it at our expense. Send coupon for book—while our liberal Introductory Offer prevails—then send for bicycle you want.

**FREE \$5. Premium Outfit!**

Make up your mind NOW to get a Ranger Motorbike or other Ranger model and we'll send you FREE of cost this \$5 Outfit. \$2 Bicycle Pump and Pump Clips, Sterling Wrench, Hub Shiners, Silver Queen Bell, Corbin Stand Lock, Steel Screw Driver, Trousers Guards, Large Can of Oil, Quick Action Motorcycle Stand, Roll of Tire Tape, Spoke Tightening Nipple Grip. All this in addition to the regular tool outfit of wrenches, repair kits, etc.

**MAIL THIS COUPON**

MEAD CYCLE CO., 19 N. Canal St., Chicago  
Without obligating me in any way, please send me your Big Bicycle Book and particulars of your No-Money-In-Advance, 30-Day Free Trial Plan. Also send me information regarding Special Liberal Terms and Particulars of Extra Inducements and Privileges.

Name.....  
Address.....

**MEAD CYCLE COMPANY**  
19 N. Canal St. CHICAGO

**ARMY AUCTION BARGAINS**  
Saddles, \$3.00 up. New uniforms, \$1.50 up.  
Army 7 shot carbine \$3.50; cteqs. 1/2c each  
U. S. N. Winchester high power rifle 6m/m. \$9.85  
Team harness \$1.65 up. C.W. Army Revolvers, \$1.65  
Remington Army Revolver, \$1.85; cteqs. 1c each  
Mauser High Power rifle with 200 cteqs. \$19.85  
15 Acres Government Auction Goods Bartrains  
illustrated and described in 428 large page wholesale and retail cyclopedic catalogue, mailed 25c east and 30c west of Mississippi River.  
FRANCIS BANNERMAN, 501 BROADWAY, NEW YORK

**TYPEWRITERS**  
\$10 and Up. All Makes  
Save \$25 to \$50  
on rebuilt at the factory by the well-known "Young Process." Sold for low cash—installment or rented. Rental applies on purchase price. Write for full details and guarantee. Free trial.  
Young Typewriter Co., Dept. 174, Chicago

**"THERE'S MONEY IN IT"**  
**AT HOME LEARN TELEGRAPHY AT HOME**  
**MORSE AND WIRELESS**  
**TEACH YOURSELF**  
in half the usual time, at trifling cost, with the wonderful Automatic Transmitter, THE OMNIGRAPH. Sends unlimited Morse or Continental messages. at any speed, just as an expert operator would.  
Adopted by U. S. Gov't. 4 styles. Catalogue free.  
**OMNIGRAPH MFG. CO.**  
39L Cortlandt St. New York

You benefit by mentioning "The Electrical Experimenter" when writing to advertisers.





# WIRELESS

operating spells OPPORTUNITY today. The great demand, rapid promotion and increased salaries make this work very attractive. We positively have good positions waiting for our graduates; operating in all parts of the world, coast-wise, transatlantic, transpacific, etc., etc. Our special Spring class for Day and Evening students starts April 2nd. Easy payments if desired.

Send for special literature.

**EASTERN RADIO INSTITUTE**  
899B Boylston St. BOSTON, MASS.



## THE

**Y. M. C. A. RADIO SCHOOL**

desires to open communication with young men wishing to qualify as

**Wireless Operators**

EXCEPTIONAL OPPORTUNITIES

Write for Booklet

**Y. M. C. A. RADIO SCHOOL**

145 East 86th St. New York, N. Y.



"Never Mind  
How Strong  
You Are—

**What Dye KNOW?"**

To-day it's a battle of wits—and brains win. Muscle and brawn don't count so much as they used to. The great question now is "What do you know?" It draws the line between failure and success, between a poor job and a good one.

What do you know? Have you special ability? Could you "make good" in a big job right now?

For 25 years the International Correspondence Schools have been training men for better work and bigger salaries. They can train YOU, no matter where you live, what hours you work, or how little your education. Mark and mail the coupon and find out—it won't obligate you in the least.

TEAR OUT HERE

INTERNATIONAL CORRESPONDENCE SCHOOLS, Box 5339, Scranton, Pa.  
Explain fully about your Course in the subject marked X:

- |   |   |                                       |
|---|---|---------------------------------------|
| <input type="checkbox"/> Civil Engineering      | <input type="checkbox"/> ADVERTISING      | <input type="checkbox"/> CHEMISTRY    |
| <input type="checkbox"/> Electrical             | <input type="checkbox"/> Salesmanship     | <input type="checkbox"/> Illustrating |
| <input type="checkbox"/> Steam                  | <input type="checkbox"/> Commercial Law   | <input type="checkbox"/> Farming      |
| <input type="checkbox"/> Mining                 | <input type="checkbox"/> Bookkeeping      | <input type="checkbox"/> Poultry      |
| <input type="checkbox"/> Mechanical             | <input type="checkbox"/> Stenography      | <input type="checkbox"/> French       |
| <input type="checkbox"/> Mechanical Drafting    | <input type="checkbox"/> Civil Service    | <input type="checkbox"/> German       |
| <input type="checkbox"/> Architectural Drafting | <input type="checkbox"/> Ry. Mail Service | <input type="checkbox"/> Italian      |
| <input type="checkbox"/> ARCHITECTURE           | <input type="checkbox"/> AUTOMOBILES      | <input type="checkbox"/> SPANISH      |

Name \_\_\_\_\_  
Address \_\_\_\_\_

ure in a great many quenched gaps on account of leakage. The writer has tried nearly everything in the line of insulating materials and has found that ordinary cardboard, impregnated with an insulating varnish containing rubber, gave the best results and at the same time was much more economical than any of the others. The number to use in each gap of course depends on the thickness of the material employed, and the total voltage to be used in the gap, and can be determined experimentally. In mounting the gap apply sufficient pressure but do not overtax the materials supporting it. The elastic limit of the materials shown in the drawing is great enough, provided reasonable care is exercised in assembling the gap and clamping the plates.

If the note of the gap is not clear after making the adjustments according to the preceding paragraphs, either the gap may be leaking, is too short, or the condensers or the gap may be brushing. There should be absolutely no brush discharge around apparatus using a quenched gap. When this condition does exist, it will invariably be found impossible to thoroly clear the note.

The coupling adjustment with the quenched gap is a delicate one and should be made carefully.

In Fig. 5 is shown graphically the general effect of the coupling adjustment on the radiated energy. These curves for the case of a quenched gap and synchronous rotary gap were obtained with the apparatus shown in Fig. 3. The sharp rise to the maximum in the case of the quenched gap is clearly shown. Another point of interest is the increased radiation over that obtained with the rotary. The maximum radiation obtained with the synchronous rotary gap was nearly 4.4 amperes, while that of the quenched transmitter was 50 per cent higher, 6.7 amperes. Decrement readings were made for each coupling adjustment to determine the boundary conditions of operation in order to keep the radiation within the limits defined in the radio legislation. It was found that at about two inches coupling, the quenched gap radiated practically one wave, while for a condition even approaching this the coupling with the rotary gap had to be loosened to 4.5 in. This resulted in the antenna current dropping to about 2 amperes, which is very low compared with the 6.6 amperes obtained with the quenched gap.

It is at once apparent from a consideration of the above results that the quenched type of spark transmitter is appreciably more efficient in every respect.

## TESTING HIGH VOLTAGES WITH SPARK GAPS.

(Continued from page 822)

tive air density should be taken from table below.

Values of relative air density and corresponding values of the correction factor are tabulated below. It will be seen that for values above .9, the correction factor does not differ greatly from the relative air density.

The Spark-Over Voltage, for a given gap, decreases with decreasing barometric pressure and increasing temperature. This correction may be considerable at high altitudes.

The spacing at which it is necessary to set a gap to spark over at some required voltage, is found as follows: Divide the required voltage by the correction factor given in Table 4. A new voltage is thus obtained. The spacing on the standard curves obtained from Table 3, corresponding to this new voltage, is the required spacing.

The voltage at which a given gap sparks over is found by taking the voltage corres-

## Marconi School of Instruction

Announces the opening of an EVENING CLASS

beginning February 1, 1917.

TECHNICAL—TRAFFIC—CODE

Instruction, Monday to Friday, beginning at 7:45 P. M.

Students Trained Without Charge

Day and evening classes convene throughout the year.

Immediate positions assured to graduates. Several hundred licensed wireless operators required coming year—fifty licensed telegraphers wanted immediately.

Call, Phone or Write

INSTRUCTING ENGINEER  
EDISON BUILDING

25 Elm Street New York City

## See The World

And



Draw A Big Salary  
As Wireless Operator

Commercial and Marine

operators in great demand. Good opportunity for you in well paid pleasant profession.

**Highland Park Course**  
Very Thoro

We teach how to build, install and maintain wireless stations. We also offer strong practical courses in Electrical Engineering.

Write today for free "Get There" booklet

**HIGHLAND PARK COLLEGE**  
291 H. P. Sta. Des Moines, Iowa

## Learn Wireless Under Marconi's Chief Instructor

### SPECIAL EVENING COURSE

for advanced amateurs begins in next 30 days. Out-of-town men should write for information about temporary day employment and living conditions while studying. Our students may enter the Marconi service direct.

Radio Operators are now in Great Demand

Great stress is laid on laboratory experiments, with complete commercial apparatus. Special training given on advanced types of Trans-Oceanic Equipment. Course under the personal supervision of the Instructing Engineer of the Marconi Co. Send today for our folder B.

**EASTERN DISTRICT Y. M. C. A.**

Marcy Ave., near Broadway Brooklyn, N. Y.  
13 minutes from New York City Hall. 18 minutes from Hudson Terminals.



## WIRELESS OPERATORS SEE THE WORLD

Positions always open. Good salaries. Day and evening sessions. Correspondence courses. Wireless apparatus for home use. Send 2 cent stamp for catalog.

Phila. School of Wireless Teleg.  
10 Parkway Bldg., Philadelphia, Pa.

You benefit by mentioning "The Electrical Experimenter" when writing to advertisers.



ponding to the spacing from the standard values of Table 3, and multiplying by the correction factor.

TABLE 4.

Air-Density Correction Factors for Sphere Gaps.

Relative air density	Diameter of standard spheres in mm.			
	62.5	125	250	500
0.50	0.547	0.535	0.527	0.519
0.55	0.594	0.583	0.575	0.567
0.60	0.640	0.630	0.623	0.615
0.65	0.686	0.677	0.670	0.663
0.70	0.732	0.721	0.718	0.711
0.75	0.777	0.771	0.766	0.759
0.80	0.821	0.816	0.812	0.807
0.85	0.866	0.862	0.859	0.855
0.90	0.910	0.908	0.906	0.904
0.95	0.956	0.955	0.954	0.952
0.95	0.956	0.955	0.954	0.952
1.00	1.000	1.000	1.000	1.000
1.05	1.044	1.045	1.046	1.048
1.10	1.090	1.092	1.094	1.096

A "SECRET" RADIO SCHOOL.

The "Transmississippi Wireless Telegraph and Wireless Telephone School" was incorporated with a capital stock of \$20,000 by Sanford Schonbrunn, Roy A. Leslie and Henry A. Meyer to "teach wireless telegraphy and telephony by a secret process."

EXPERIMENTAL CHEMISTRY.

(Continued from page 826)

It is used:—

- [1] As a basis of various inks, as India ink and printers' ink, as well as an ingredient of black paint, etc.
- [2] Also as an ingredient of stove-polish.

EXPERIMENT NO. 37—

Have lighted a candle, the oil of a kerosene lamp, and the gas of a fish-tail burner, also of a Bunsen burner. Take a piece of glass and hold it across the flame of the candle and notice if any deposit is left on the glass. In the same manner hold a piece of glass over the kerosene lamp, over the fish-tail burner, and the Bunsen burner.

Do these substances tested contain the same elements? This is ascertained by comparing the results of the products on the glasses.

It will be noticed and remembered that the same element is contained in three different forms—namely, in the case of the candle as a solid; in the kerosene as a liquid, and in the gas emitted from the fish-tail burner, as a gas. The reason no deposit is left from the gas of the Bunsen burner is because there is almost perfect combustion taking place in this case.

The deposit left on all the glasses is called Lampblack.

Coke:—

Coke is a fuel obtained by heating coal in confined places. This is done sometimes in heaps, just as charcoal is made from wood, but more frequently in ovens. It is also a by-product in the manufacture of illuminating gas, remaining in the retort after the volatile portions, which go to make gas, have been driven off by the destructive distillation. Coke is a hard, irregular, brittle and porous solid, having a grayish and sometimes metallic luster. It does not burn so easily as coal and in consequence requires a constant draft of air. Its combustion is accompanied with great heat and but little smoke, which is a highly desirable quality in separating metals from their ores. Also it does not become pasty in the fire and some of the sulfur of the coal is driven off. It is used in metallurgical operations as a

# Wireless Taught By Mail

**You May Learn Theory, Code and Laws of Radio Communication in Our School or at Your Home**



fitting you for positions paying good salaries with wonderful chance to travel the world over. It's the most interesting profession known and the demand for skilled operators is increasing.

Send stamp for catalog giving facts. Resident classes open Oct. 2nd.

NATIONAL RADIO SCHOOL, 14th & U Sts., N. W., Washington, D. C.

## WASHINGTON

Offers Special Advantages for These Courses.

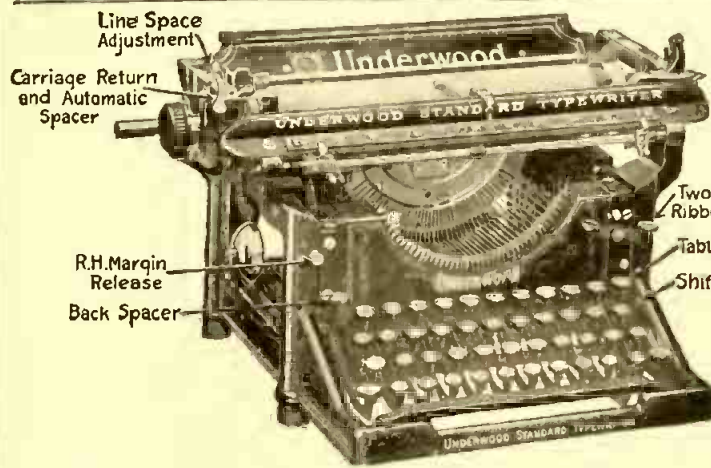

I want, through this advertisement, to establish as friendly business relations with you as I possibly can. I want you to realize also, that it is my earnest effort and intention to give you full, honest value for every dollar that you spend with me. This is the only way I can succeed. My advertisement has appeared in this magazine continuously for more than four years.

I am building up my business on the foundation of good value and square dealings. I am saving thousands of satisfied customers thousands of dollars by supplying perfect—late style—visible writing—typewriters, at remarkably low prices.

All my transactions are handled throughout by personal correspondence. I assure you every courtesy and consideration in your dealings with me. Your order will have my prompt, careful, personal attention. I will be glad to do business with you.

*Harry A. Smith*

ALL LATEST IMPROVEMENTS

# TYPEWRITER SENSATION

*Free TRIAL—Use as You Pay*

Send me only \$3.00 a month until the low total price of \$49.15 is paid, and the machine is yours

This is absolutely the most generous typewriter offer ever made. Do not rent a machine when you can pay \$3.00 a month and own one. Think of it—Buying a \$100.00 machine for \$49.15. Cash price \$46.45. Never before has anything like this been attempted.

## STANDARD UNDERWOOD VISIBLE

Perfect machines, Standard Size, Keyboard of Standard Universal Arrangement, writing the full 84 characters—universally used in teaching the touch system. The entire line of writing completely visible at all times, has the inbuilt tabulator, with billing devices, the two-color ribbon—with automatic reverse and key controlled shift, automatic flexible paper feed—automatic paper fingers the back spacer—roller bearing carriage action—in fact every late style feature and modern operating convenience. Comes to you with everything complete, tools, cover, operating book and instructions, ribbon, practice paper—nothing extra to buy. You cannot imagine the perfection of this beautiful reconstructed typewriter until you have seen it. I have sold several thousand perfect latest style machines at my bargain price and everyone of these thousands of satisfied customers had the beautiful, strictly up-to-date machine on 5 days' free trial before deciding to buy it. I will send it to you F.O.B. Chicago for five days' free trial. It will sell itself, but if you are not satisfied that this is the greatest typewriter you ever saw, you can return it at my expense. You won't want to return it after you try it—you cannot equal this wonderful value anywhere.

**You Take No Risk—Put in Your Order Now**

When the typewriter arrives deposit with the express agent \$7.15 and take the machine for five days' trial. If you are convinced that it is the best typewriter you ever saw, keep it and send me \$3.00 a month until my bargain price of \$49.15 is paid. If you don't want it, return it to the express agent, receive your \$7.15 and return the machine to me. I will pay the return express charges. This machine is guaranteed just as if you paid \$100.00 for it. It is standard. Over one hundred thousand people own and use these typewriters and think them the best ever manufactured. The supply at this price is very limited, the price will probably be raised when my next advertisement appears, so don't delay. Fill in the coupon today—mail to me—the typewriter will be shipped promptly. There is no red tape. I employ no solicitors—no collectors—no chattel mortgage. It is simply understood that I retain title to the machine until the full \$49.15 is paid. You cannot lose. It is the greatest typewriter opportunity you will ever have. Do not send me one cent. Get the coupon in the mails today—sure.

**H. A. SMITH**  
Room 738  
231 N. Fifth Ave.  
CHICAGO, ILL.

Ship me the UNDERWOOD F.O.B. Chicago, as described in this advertisement. I will pay you the \$42.00 balance of the SPECIAL \$49.15 purchase price at the rate of \$3.00 per month. The title to remain in you until fully paid for. It is understood that I have five days in which to examine and try the typewriter. If I choose not to keep it, I will carefully repack it and return it to the express agent. It is understood that you give the standard guarantee for one year.

Name .....

Address .....

**HARRY A. SMITH**  
738-231 N. Fifth Avenue Chicago

*You benefit by mentioning "The Electrical Experimenter" when writing to advertisers.*



**\$250 a Month**

The master-piece of watch manufacture—adjusted to the second, positions, temperature and isochronism. Encased at factory into your choice of the exquisite new watch cases.

**21 Jewel Burlington**

All sizes for both men and women

The great Burlington Watch sent on simple request. Pay at rate of \$2.50 a month. You get the watch at the same price even the wholesale jeweler must pay.

**Write Today for Free Watch Book**

See handsome color illustrations of all the newest designs in watches that you have to choose from. Your name and address on a postcard is enough. Get this offer while it lasts. Write today.

Burlington Watch Co. Dept. 7443 19th & Marshall Blvd. Chicago

**DON'T BE THIN!**

Physical Perfection attracts men and women, for we all admire a well-developed person. Have you noticed that it is the chesty fellow who gets the best job? In fact he seems to get ahead in every way. I will give you a straight back, a full chest and an elastic stride, three of the best signs of vigor; besides, I guarantee to increase your weight 10 to 30 lbs., by building you up scientifically, naturally, without apparatus or drugs, in the privacy of your own room. Write today for information.

**EDWARD J. RYAN, Martin Bldg., Utica, N.Y.**

**WANTED MEN!**

**\$75 TO \$300 A MONTH!**

Demand for capable automobile and tractor men far exceeds the supply. Our graduates secure good paying positions as Salesmen, Demonstrators, Factory Testers, Garage Managers, Drivers and Tractor Experts.

**\$50 Course FREE**

Only six weeks required to train you in this great school. Most complete instruction. Instructors all experts. Enroll now and receive \$50 Course in Tractor and Lifting Engineering Free. Write today for our big Free Book and \$50 Free Scholarship Certificate.

**BAHE'S AUTOMOBILE TRAINING SCHOOL**  
Largest Auto Training School in the World.  
512 E 11th St., Kansas City, Mo.

**TRAVELING MEN**

**EARN \$2,000 TO \$10,000 A YEAR**

We will teach you to be a high grade salesman in eight weeks at home and secure you desirable positions from a large number of reliable firms who offer our students opportunities to earn big pay while they are learning. No former experience required. Write today for particulars, list of hundreds of good openings and testimonials from hundreds of our students now earning \$100 to \$200 a month. Address nearest office. Dept. 631

**NATIONAL SALESMEN'S TRAINING ASSN.**  
Chicago New York San Francisco

**Be a Doctor of Chiropractic**

**4 Lessons FREE!**

These books tell of this wonderful science of spinal adjustment. Read like fiction, yet absolutely true. 30,000,000 Americans support Chiropractic. Thousands being cured of long-standing diseases by it.

**Big Opportunity for Ambitious Men and Women. Resident and Home Study Courses. Large demand for practitioners—\$2,000 to \$5,000 Yearly. Small Expenses. Easy payments. We fit you for State Board requirements. FREE! Elbert Hubbard's Book, "The New Science." Mail postal, get all five books FREE.**

**National School of Chiropractic**  
Dept. E13 421 S. Ashland Blvd. CHICAGO

**BY THE WAY—**  
Have you seen page 862 yet?  
**BETTER LOOK AT IT NOW.**

reducing agent. Also in smelting and refining metals from their ores.

**EXPERIMENT NO. 38—**

With a new set of apparatus used in Experiment 35, and in the place of wood, fill the test tube with finely crushed Soft Coal. Heat as before and record your results. Test the gas at the end of the stricture tube by applying a flame to the end. What were the results? After the heating is complete, examine and see if you can identify the substance left in the test tube. Test the contents of the bottle with both red and blue litmus paper and record your results. The three products of the destructive distillation of coal are [1] a gas; [2] a liquid, and [3] coke, which is left in the test tube in place of the original coal.

**Mineral Coal:—**

Mineral coal is a compound, especially of carbon or of decomposed woody matter with inflammable substances and hydrogen and oxygen gases. There are two chief varieties of coal [1] Anthracite and [2] Bituminous, and several less important varieties.

[a] Anthracite coal:—This is a very hard, lustrous, and shiny coal, and breaks into lumps. It burns steadily with little or no flame, giving off great heat and requiring a high temperature to set it on fire. It is used very extensively for heating purposes.

[b] Bituminous coal:—Bituminous coal, though still hard, breaks more easily than anthracite. It burns at a much lower temperature than hard coal with a bright yellow flame, giving off less heat and liberating volumes of smoke. It is less rich in carbon than anthracite, but is much richer in hydrocarbons. As it gives up so many gases rich in hydrocarbons, it is used in the manufacture of illuminating gas, and the product of distillation furnishes coke.

Cannel coal is a variety of Bituminous coal, and is so rich in hydrocarbons that it may be lighted with a match. This is a very expensive variety and found in but few localities. On account of the large proportion of volatile matter contained in it, this coal is much used in England for gas making.

Lignite is a brown coal of more recent formation than the previous varieties. It frequently retains the structure of the wood from which it was formed, and contains from 50 to 80 per cent of carbon.

Jet is a variety of brown coal, so compact as to take a fine polish.

Pete and Turf are other varieties of coal and are less pure forms of carbon, being made up of roots of plants, etc.

**Formation of Coal:—**

The one theory now generally accepted is that the rank and luxuriant vegetation which prevailed during the carboniferous age grew and decayed upon land but slightly raised above the sea; that by slow subsidence this thick layer of vegetable matter sank below the water and became gradually covered with sand, mud, and other mineral sediment; and then, by some slight upheaval of the bottom of the sea or other process, a land surface was once more formed and covered with a dense mass of plants, which in the course of time decayed and became overlaid with silt and sand as before. At length thick masses of stratified matter would accumulate, producing great pressure, and this, acting along with chemical changes, would gradually mineralize the vegetable layers into coal.

**EXPERIMENT NO. 39—**

Mix 5 grams of Copper oxid [CuO] with 1 gram of powdered charcoal. Pour the mixture into a test tube and arrange the apparatus as shown by Fig. 50, allowing the gas which is liberated when the tube is heated to bubble thru a little limewater, contained in test tube D.

Heat the tube, commencing at the part around the upper part of the mixture, and

**COME TO DETROIT, THE AUTOMOBILE CENTER AND LEARN THE AUTOMOBILE BUSINESS**

Detroit trained men get preference and jobs quickly. Think what it means to learn in the Michigan State Auto School. Factories endorse our School, glad to employ our graduates or offer them territory. Men are needed everywhere as testers, repair men, chauffeurs, garage men. Hundreds of our graduates start in business for themselves.

**Earn \$75 to \$300 a Month**

We teach you to handle any auto proposition. Students actually build cars from start to finish, getting factory training in assembling, block-testing, road testing, everything cutting, separate from regular course. All leading types of starting, lighting and ignition systems in operation. Six-cylinder Lozier, eight-cylinder King used for road instruction. We have Chalmers "6-30" chassis with 3400 r. p. m. motor, a 1917 Buick 5 and Overland, Delco System, used in Buick, Hudson, Packard Twin-6, 1917-Willys-Knight complete chassis.

**Start Any Time**

44 auto factories in Detroit and 140 parts factories. We operate Westinghouse, Autolite, Bijur Service Stations. Students get actual experience in handling all kinds of electrical equipment. Just installed a Sprague Electric Dynamometer for block-testing purposes for students' use. School open all the year. Graduate in 10 to 12 weeks. Enter classes any time, any day. Three classes daily: morning, afternoon, evenings.

**Factory Cooperation**

We have arrangements with the Auto factories to put them in touch with men who intend going into business for themselves.

**Buildings—Equipment**

33,000 sq. ft. of additional floor space, thousands of dollars worth of new equipment, plenty of room for students to work in our new building at 687-89-91 Woodward Avenue. Students come from all over the world.

**Act Quickly—Don't Wait**

Get full particulars, "Auto School News" and New Catalog, both absolutely free, or better still, jump on the train, as hundreds have done, and come to Detroit, the "Heart of the Automobile Industry," and learn right.

**Michigan State Auto School**  
The Old Reliable School  
A. G. Zeller, Pres.  
663 Auto Bldg., 687-89-91 Woodward Avenue, 11-19 Selden Ave., DETROIT, MICH., U.S.A.

**Money Back Guarantee**

We guarantee to qualify you in a short time for a position as chauffeur, repair man, tester, demonstrator, garage man, or automobile dealer paying from \$75 to \$300 monthly or refund your money.

**DETROIT THE HEART OF THE AUTO INDUSTRY**

44 AUTOMOBILE FACTORIES 140 ACCESSORY FACTORIES

**\$60 A WEEK AND THIS FREE AUTOMOBILE**

EVERY AGENT CAN GET AN AUTO FREE NO CONTEST

**Guaranteed For 10 Years**

You—yourself—can positively make \$60 a week and get a Free Auto. I want men, hustling, energetic, ambitious fellows, anxious to make money, who are willing to work with me. Not for me, but with me. Are you that kind? I want you to advertise, sell, and appoint local agents for the biggest, most sensational seller in 50 years—the ROBINSON FOLDING BATH TUB. Demonstrating Tub Furnished. Here's an absolutely new invention—nothing like it. Makes instant appeal. Sells easily. Gives every home a modern up-to-date bathroom in any part of the house. No plumbing, no waterworks needed. Folds in small roll, handy as an umbrella. Self-emptying and positively unbreakable. Absolutely guaranteed for 10 years. Remember, fully 70% of homes have no bath rooms.

**Sensational Sales Successes**

Two sales a day means \$300 a month. Breeze, of Idaho, made \$400 profit in 30 days. Rev. Otto Schulze, Mo., got \$1000 to date. Burkholder, Mont., orders \$1072 in 17 days. Hamilton, of Wyo., made \$50 first two days. Hundreds like that. Pleasant, permanent, fascinating work. Write a postcard. Let me write you a long letter. No experience needed, no capital. Your credit is good if you mean business. But you must be ambitious, you must want to make money. That's all. Write a postcard now. I want to pay you \$50 every week.

**H. S. ROBINSON, PRES. THE ROBINSON CABINET MFG. CO.**  
4245 Factories Bldg. Toledo, Ohio

**Do Business by Mail**

It's profitable, with accurate lists of prospects. Our catalogue contains vital information on Mail Advertising. Also prices and quantity on 6,000 national mailing lists, 99% guaranteed. Such as

War Material Mfrs.	Wealthy Men
Cheese Box Mfrs.	Axle Grease Mfrs.
Shoe Retailers	Auto Owners
Contractors	Tin Can Mfrs.
Druggists	Farmers, Etc.

Write for this valuable reference book, also prices and samples of fac-simile letters. Have us write or revise your Sales Letters.

Ross-Gould, 1009T Olive St.

**Ross-Gould Mailing Lists St. Louis**

You benefit by mentioning "The Electrical Experimenter" when writing to advertisers.



gradually moving the flame toward the closed end of the tube. Observe and record the change that takes place in the lime-water. Can you remember any other experiment which you performed, that caused a similar change in lime-water? By comparing such experiments could you identify this gas as Carbon Dioxid [CO<sub>2</sub>]?

EXPERIMENT NO. 40—

Allow the tube heated in the foregoing experiment to cool and when cold pour its contents into a 200 cc. beaker. Let a small stream of water flow into the beaker. What substance is carried away by the water? What is left in the beaker? What element is taken from the Copper Oxid? Assuming that Carbon Monoxid has been liberated, the following would be the equation if the experiment was performed under proper conditions:

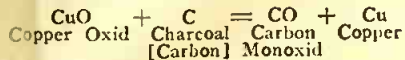

EXPERIMENT NO. 41—

Thoroughly mix a little boneblack with some cider vinegar in a small beaker. Fold a filter paper and place it in a funnel. Pour some boneblack on the filter paper and scoop out a hollow in the center of the boneblack. Into this hollow pour the mixture of vinegar and boneblack. Collect the filtrate and note its color. Filter a solution of Copper Sulfate thru boneblack. Can the color be removed from all liquids by filtering them thru boneblack? Try a solution of red ink and water. From these experiments can you form a conclusion why crude sugar is dissolved in water and filtered thru boneblack?

EXPERIMENT NO. 42—

Place a small piece of Ferrous Sulfid in a test tube and add 10 cc. of water and 5 cc. of dilute Sulfuric Acid. Result. Note the odor. When the action becomes vigorous, half fill the tube with boneblack. Shake and observe the odor. If definite results are not obtained cork the tube and if the tube leaks make the opening gas-tight by rubbing vaseline around the opening, and shake thoroly. [Hydrogen Sulfid solution may be used in place of the Ferrous Sulfid and Sulfuric Acid, as these two compounds are used to produce Hydrogen Sulfid.]

# FIRE SALE!! OF SLIGHTLY DAMAGED BOOKS

A fire in our stock rooms caused many books to be damaged by smoke and water. Every one is good except for covers and contains just as much valuable information as when it was new. *But we can't sell them for new.* Rather than dispose of them to dealers, we prefer to give our readers the benefit. What we offer you is a combination of



- Our Celebrated Wireless Course (160 p. 400 illus. flexible cloth) Reg. Price \$1.00.
- List of Radio Stations of the World (Call letters and location of every station in the world) stiff cloth, Reg. Price \$5.00.
- The Experimental Electricity Course (160 p. 350 illus. stiff cloth) Reg. Price \$1.00.
- How to Make Wireless Sending Instruments (100 p. paper) Reg. Price \$25.

**ALL FOR \$1.50 PREPAID**

*Remember the books are damaged but in many cases only the bindings have a few water spots. But every book is absolutely complete.*

This is the biggest bargain in books we have ever offered. You should take advantage of it at once. Send to-day. Reimit by cash, postal or express money order to

**THE EXPERIMENTER PUBLISHING CO., Inc., 233 FULTON STREET NEW YORK CITY, N. Y.**

## LOOK HERE, EXPERIMENTERS

A COMPLETE CHEMCRAFT OUTFIT FOR ONLY \$1.50 POSTAGE PAID ANYWHERE IN UNITED STATES OR CANADA

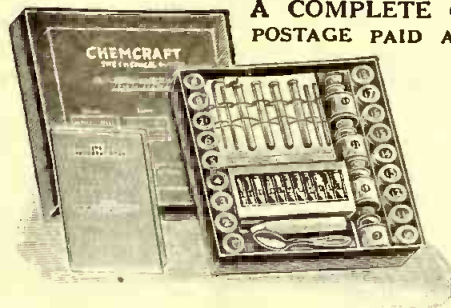

Chemcraft No. 1 contains fourteen chemicals, Test Tubes, Glass Tube, Measure, etc., and a valuable instruction book telling how to work 36 wonderful experiments in Chemistry and Chemical Magic.

You can make gunpowder, colored fire and fire ink, manufacture fuses, make black and colored writing inks, prepare chlorine and hydrogen sulphide. You can prepare magic inks and papers, change water to wine and wine into water and do dozens of others. These experiments can be repeated many times and the outfit contains all the chemicals and apparatus you will need. With Chemcraft No. 1 you can also devise many new experiments of your own.

This picture shows Chemcraft No. 2, which contains 32 chemicals with complete apparatus and instructions for working 85 experiments in Chemistry and Chemical Magic. Price, postage paid, \$2.50. West of the Mississippi and to Canada, \$3.00.

**Chemicals and Apparatus for the Experimenter**  
We have just completed a price list of chemicals and apparatus for experimenters. Send 10c in coin or stamps for a copy of this list. It will be valuable to you.

Dealers, Write for Discounts on the Chemcraft Line

**THE PORTER CHEMICAL COMPANY**  
Department B. Hagerstown, Md.



### Super-Sensitive Microphone Only \$6

This instrument is offered at an extremely low price. It is excellent for building your own radio amplifier. Can also be used in many experiments where a sensitive microphone is required.

### Detectograph \$12

This detecting instrument of marvelous sensitivity can be used for detecting secret conversations. Outfit consists of Sensitive Transmitter, 25-ft. Black Cord, Receiver, Head-band, Case and Battery.



Send for One Today and Convince Yourself

**MICROPHO-DETECTOR COMPANY, Gaston Boissonnault, President, 119 Nassau St., New York**  
Makers of Super-Sensitive Microphone Apparatus

# FOX TYPEWRITERS

## Factory Rebuilt, Like New, at \$52.50

The word "rebuilt" has been abused and misused until it has become a meaningless trade term.

When we rebuild a Fox Typewriter we take it all to pieces, re-nickel the nickel parts, re-enamele the frame and replace all worn parts with new ones. The same men who originally built the typewriter do this rebuilding and do the work just as good.

### 40% New Parts and Three Years' Guarantee

We offer a rebuilt Fox Typewriter, Model No. 24—just like new—for \$52.50. These have standard carriages, taking paper 10 1/2 inches wide, any kind of keyboard, any kind of type, rubber covers, tabulators, back spacers, two-color ribbons, complete with instruction books and cleaning outfits, and are guaranteed for 3 years, the same as new ones, and to have not less than 40% of new parts.

Send any amount you can spare, from \$1 up, as a first payment, and pay the balance \$5.00 monthly. 5% discount for all cash. Purchaser must pay transportation. If \$10.00 or more is sent with order we will include FREE a Fox Solid Oak Typewriter Table selling at \$4.50. Please order direct from this offer and inclose any amount you can spare—and be sure and mention The Electrical Experimenter for March.

**FOX TYPEWRITER CO., 8702-8752 FRONT AVE., GRAND RAPIDS, MICHIGAN**

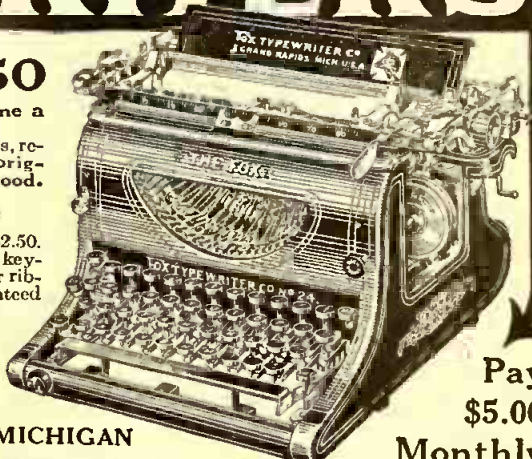

**Pay \$5.00 Monthly**

You benefit by mentioning "The Electrical Experimenter" when writing to advertisers.



# Free to You!

## Read this Remarkable Offer!

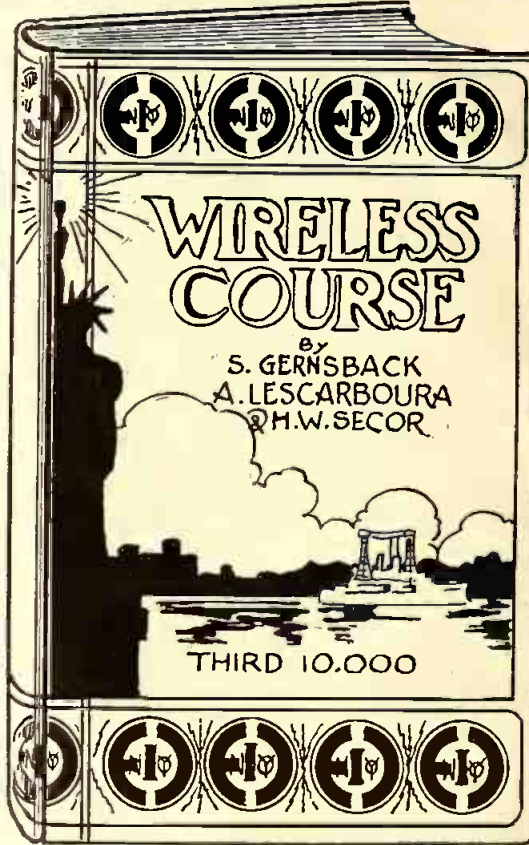
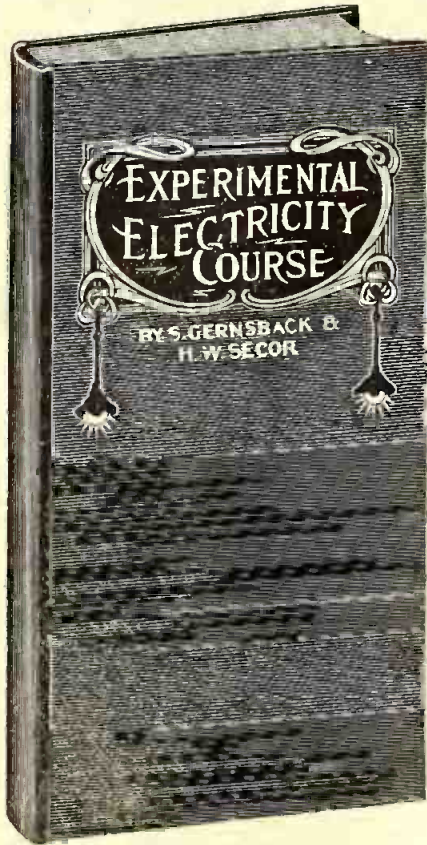

This masterpiece contains 160 pages, 400 illustrations. Size of book 5" x 9". Printed on extra thin paper, so book can be slipped in pocket. Handsome stiff cloth cover. Price \$1.00 if bought alone. FREE with a year's subscription.

The most comprehensive Wireless Course ever printed. Contains 160 pages, 350 illustrations. Size of book 6½" x 9". Very fine flexible linen cover. Price \$1.00 if bought alone. FREE with a year's subscription.



12 copies of THE ELECTRICAL EXPERIMENTER make a book 9" x 12" and 4" thick. This book will weigh 7 lbs. It is the greatest Electrical and Wireless reference work in the world. And all for \$1.50

This is a very limited offer. It may be withdrawn at any time, due to the tremendous cost of paper, which IS JUST DOUBLE WHAT IT WAS ONE YEAR AGO. We only have about 2000 each of these fine books on hand; after they are gone we cannot reprint the books until conditions become normal again. THIS MAY BE TWO YEARS OR MORE. *Now is your chance.*

The publishers of this journal have earned an enviable reputation of giving more than 100 cents' worth for each dollar spent with them. Profit by this liberal opportunity NOW; it may never be made again.

### HERE'S THE OFFER

Subscribe to THE ELECTRICAL EXPERIMENTER for one year, at the regular subscription price of \$1.50 per year (Canada and foreign \$2.00) and we will send you FREE POSTPAID, either one of the above books. If you subscribe for two years, BOTH BOOKS WILL BE GIVEN FREE, POSTPAID.

If you are a subscriber at present, take advantage of this wonderful opportunity anyway. If you do, we will extend your present subscription for one year.

**This Offer Limited. Act Now**

**EXPERIMENTER PUB. CO.,**  
233 FULTON STREET,  
NEW YORK CITY

3-17

Gentlemen:

Please enter my subscription to THE ELECTRICAL EXPERIMENTER for the term of . . . . . year . . . . . for which I enclose herewith \$ . . . . .

You will also send me at once FREE prepaid your . . . . . book . . . . .

Name . . . . .

Address . . . . .

FILL IN - TEAR OUT - AND MAIL